

Bastrop, TX City Council Meeting Agenda
Bastrop City Hall City Council Chambers
1311 Chestnut Street
Bastrop, TX 78602
(512) 332-8800



November 13, 2018 at 6:30 P.M.

City of Bastrop City Council meetings are available to all persons regardless of disability. If you require special assistance, please contact the City Secretary at (512) 332-8800 or write 1311 Chestnut Street, 78602, or by calling through a T.D.D. (Telecommunication Device for the Deaf) to Relay Texas at 1-800-735-2989 at least 48 hours in advance of the meeting.

As authorized by Section 551.071 of the Texas Government Code, this meeting may be convened into closed Executive Session for the purposes of seeking confidential legal advice from the City Attorney on any item on the agenda at any time during the meeting.

The City of Bastrop reserves the right to reconvene, recess, or realign the Regular Session or called Executive Session or order of business at any time prior to adjournment.

PLEASE NOTE: ANYONE WISHING TO ADDRESS THE COUNCIL MUST COMPLETE A CITIZEN COMMENT FORM AND GIVE THE CARD TO THE CITY SECRETARY PRIOR TO THE START OF THE CITY COUNCIL MEETING.

1. **CALL TO ORDER**
2. **PLEDGE OF ALLEGIANCE** – Parker Krcmar and Remy Yzaguirre, Red Rock Elementary PALS Program

TEXAS PLEDGE OF ALLEGIANCE
Honor the Texas Flag; I pledge allegiance to thee, Texas, one state under God, one and indivisible.
3. **INVOCATION** – Pastor Ervin Jackson, Police Chaplain
4. **PRESENTATIONS**
 - 4A. Mayor's Report
 - 4B. Councilmembers' Report
 - 4C. City Manager's Report
 - 4D. A proclamation of the City Council of the City of Bastrop, Texas recognizing November 5-9, 2018, as Municipal Court Week.

A handwritten signature in blue ink, located in the bottom right corner of the page. The signature is stylized and appears to be a name with a large, sweeping flourish.

5. WORK SESSION/BRIEFINGS – N/A

6. STAFF AND BOARD REPORTS

- 6A. Receive presentation from Bastrop Housing Authority on their 2018 Annual Report.
- 6B. Provide Update on FY 2018 Organizational Work Plan Accomplishments & Discuss FY 2019 Organizational Work Plan.

7. CITIZEN COMMENTS

At this time, three (3) minute comments will be taken from the audience on any topic. To address the Council, please submit a fully completed request card to the City Secretary prior to the beginning of the Citizens' Comment portion of the Council meeting. In accordance with the Texas Open Meetings Act, if a citizen discusses any item not on the agenda, City Council cannot discuss issues raised or make any decision at this time. Instead, City Council is limited to making a statement of specific factual information or a recitation of existing policy in response to the inquiry. Issues may be referred to City Staff for research and possible future action.

To address the Council concerning any item on the agenda, please submit a fully completed request card to the City Secretary prior to the start of the meeting.

It is not the intention of the City of Bastrop to provide a public forum for the embarrassment or demeaning of any individual or group. Neither is it the intention of the Council to allow a member of the public to slur the performance, honesty and/or integrity of the Council, as a body, or any member or members of the Council individually or collectively, or members of the City's staff. Accordingly, profane, insulting or threatening language directed toward the Council and/or any person in the Council's presence will not be tolerated.

8. CONSENT AGENDA

The following may be acted upon in one motion. A Councilmember or a citizen may request items be removed from the Consent Agenda for individual consideration.

- 8A. Consider action to approve City Council minutes from the October 23, 2018 meeting.
- 8B. Consider action to approve the second reading of Ordinance No. 2018-30 amending the budget for the Fiscal Year 2019 in accordance with existing statutory requirements; appropriating the various amounts herein as attached in Exhibit "A"; repealing all prior ordinances and actions in conflict herewith; and providing for an effective date.
- 8C. Consider action to approve Resolution No. R-2018-111 of the City Council of the City of Bastrop, Texas, approving the Pecan Park, Section 3F Final Plat, being 1.758 acres out of the Mozea Rousseau Survey, Abstract 56, located east of the extension of Trailside Lane, within the city limits of Bastrop, Texas, as shown in Exhibit A; repealing all conflicting resolution; and providing an effective date.
- 8D. Consider action to approve Resolution No. R-2018-112 of the City Council of the City of Bastrop, Texas abandoning a ten-foot (10') easement, forty feet (40') in length, located within a one-hundred and ninety foot (190') Public Utility Easement (PUE) located along



the northern property line of Lot 2, Chestnut Square Subdivision, being located in Bastrop, Texas, as shown in Exhibit "A"; providing for a repealing clause; and establishing an effective date.

9. ITEMS FOR INDIVIDUAL CONSIDERATION

- 9A. Consider action and approve Resolution No. R-2018-113 of the City Council of the City of Bastrop, Texas, making determinations regarding certain project-specific Exceptions and/or Exemptions as provided by Emergency Ordinance No. 2018-1, Section 8 (Temporary Moratorium); and Emergency Ordinance 2018-2, Section 7 (Emergency Drainage Application Rules).
- 9B. Hold public hearing and consider action to approve the first reading of Emergency Ordinance No. 2018-1-A of the City Council of the City of Bastrop, Texas, extending the temporary moratorium, Emergency Ordinance No. 2018-1, enacted August 23, 2018; including a severability clause; establishing an effective date and motion to include on the November 15, 2018 Special Meeting Agenda.
- 9C. Hold public hearing and consider action to approve the first reading of Ordinance No. 2018-33 of the City Council of the City of Bastrop, Texas, granting a Conditional Use Permit to allow a manufactured house on 0.572 acres of Farm Lot 65, East of Main Street, located at 1603 State Highway 95, an area zoned A/OS, Agricultural/Open Space, within the city limits of Bastrop, Texas; as shown in Exhibits A and B; setting out conditions; including a severability clause; establishing an effective date and motion to include on the November 27, 2018 Consent Agenda.
- 9D. Consider action to approve Resolution No. R-2018-93 of the City Council of the City of Bastrop, Texas awarding a community support service agreement for services associated with operating, marketing and providing cultural art and theater services, to the Bastrop Opera House, at a cost of Ninety-Two Thousand and Five-Hundred and 00/100 Dollars (\$92,500), attached as Exhibit A; authorizing the City Manager to execute all necessary documents for the contract; providing for a repealing clause; and establishing an effective date.
- 9E. Consider action to approve Resolution No. R-2018-94 of the City Council of the City of Bastrop, Texas awarding a community support service agreement for services for operating, marketing and staffing a historical museum and visitor center and providing visitor center services, to the Bastrop County Historical Society, at a cost of One Hundred Forty-Six Thousand Nine-Hundred Thirty-Seven and 00/100 Dollars (\$146,937), attached as Exhibit A; authorizing the City Manager to execute all necessary documents for the contract; providing for a repealing clause; and establishing an effective date.
- 9F. Consider action to approve Resolution No. R-2018-95 of the City Council of the City of Bastrop, Texas awarding a Community Support Service Agreement associated with providing recreation and pool services, to the YMCA of Austin/Bastrop Branch, at a cost of Seventy-Nine Thousand and Eight Hundred and 00/100 Dollars (\$79,800), attached as Exhibit A; authorizing the City Manager to execute all necessary documents for the contract; providing for a repealing clause; and establishing an effective date.
- 9G. Consider action to approve Resolution No. R-2018-109 of the City Council of the City of Bastrop, Texas, approving a Site Agreement Lease for Air Quality Monitoring with the Capital Area Council of Governments (CAPCOG) for a portion of property in the City's Mayfest Park, located at 25 American Legion Drive, for a term of five (5) years at a total



rent of One and 00/100 Dollar (\$1.00); attached as Exhibit A; authorizing City Manager to execute all appropriate documentation; providing for a repealing clause; and establishing an effective date.

- 9H. Consider action to approve the first reading of Ordinance No. 2018-31 amending the budget for the Fiscal Year 2019 in accordance with existing statutory requirements; appropriating the various amounts herein as attached in Exhibit "A"; repealing all prior ordinances and actions in conflict herewith; providing for an effective date; and move to include on the November 27, 2018 City Council consent agenda for a second reading.
- 9I. Consider action to approve Resolution No. R-2018-106 of the City Council of the City of Bastrop, Texas approving a Wholesale Water Service Agreement with Aqua Water Supply Corporation, attached as Exhibit A; authorizing the City Manager to execute all necessary documents; providing for a severability clause; and establishing an effective date.

10. EXECUTIVE SESSION

- 10A. City Council shall convene into closed executive session pursuant to Section 551.071 of the Texas Government Code to confer with City Attorney regarding legal advice related to the status of the 1445 Interlocal Agreement between the City of Bastrop and Bastrop County for the review of subdivision applications in the City's extraterritorial jurisdiction.
- 10B. City Council shall convene into closed executive session pursuant to Sections 551.071 of the Texas Government Code to confer with City Attorney seeking legal advice regarding statutory and home-rule charter parameters for public notices, public hearings, community engagement, and city council involvement in the Building Bastrop initiative.
- 10C. City Council shall convene into closed executive session pursuant to Sections 551.071 of the Texas Government Code to confer with City Attorney seeking legal advice regarding the settlement of outstanding mowing liens on property located at 1002 Church Street.

11. TAKE ANY NECESSARY OR APPROPRIATE ACTION ON MATTERS POSTED FOR CONSIDERATION IN CLOSED/EXECUTIVE SESSION

12. ADJOURNMENT

I, the undersigned authority, do hereby certify that this Notice of Meeting as posted in accordance with the regulations of the Texas Open Meetings Act on the bulletin board located at the entrance to the City of Bastrop City Hall, a place of convenient and readily accessible to the general public, as well as to the City's website, www.cityofbastrop.org and said Notice was posted on the following date and time: Friday, November 9, 2018 at 10:00 p.m. and remained posted for at least two hours after said meeting was convened.

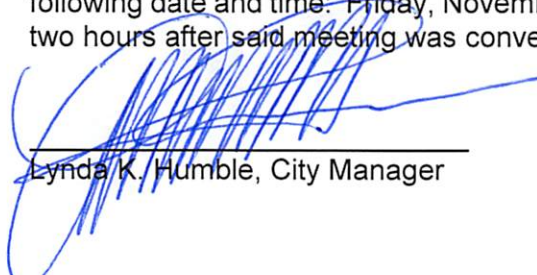
Lynda K. Humble, City Manager



STAFF REPORT

MEETING DATE: November 13, 2018

AGENDA ITEM: 4A

TITLE:

Mayor's Report

STAFF REPRESENTATIVE:

Lynda Humble, City Manager

POLICY EXPLANATION:

Texas Local Government Code, Section 551.045 – Governing Body of Municipality or County: Reports about Items of Community Interest Regarding Which No Action Will Be Taken:

(a) Notwithstanding Sections 551.041 and 551.042, a quorum of the governing body of a municipality or county may receive from staff of the political subdivision and a member of the governing body may make a report about items of community interest during a meeting of the governing body without having given notice of the subject of the report as required by this subchapter if no action is taken and, except as provided by Section 551.042, possible action is not discussed regarding the information provided in the report.

(b) For purposes of Subsection (a), "items of community interest" includes:

- (1) expressions of thanks, congratulations, or condolence;
- (2) information regarding holiday schedules;
- (3) an honorary or salutary recognition of a public official, public employee, or other citizen, except that a discussion regarding a change in the status of a person's public office or public employment is not an honorary or salutary recognition for purposes of this subdivision;
- (4) a reminder about an upcoming event organized or sponsored by the governing body;
- (5) information regarding a social, ceremonial, or community event organized or sponsored by an entity other than the governing body that was attended or is scheduled to be attended by a member of the governing body or an official or employee of the political subdivision; and
- (6) announcements involving an imminent threat to the public health and safety of people in the political subdivision that has arisen after the posting of the agenda.

ATTACHMENTS:

- Power Point Presentation

Mayor's Report
November 13, 2018



Latest Activities

October 12 - 26

Events in 2018: 316

Vacation



Interviewed by Gabriel



Early Voting
Started: Oct 22
Election Nov 6

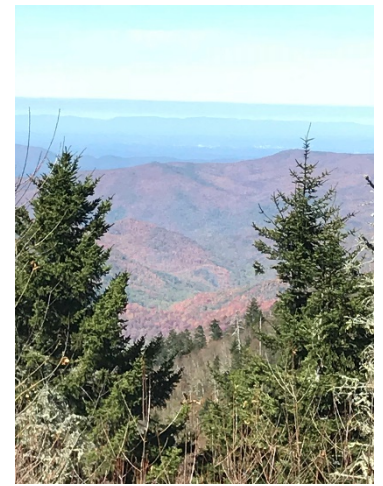

Chairman McCaul



Inspire, Empower & Thrive :
Family Crisis Luncheon



Building Bastrop
Open House:
Bastrop DNA
Analysis



Planned Events

October 26 – November 13

- October 31 – Bastrop Halloween Bash at **Mayfest Park** 5-8 pm (Thanks YMCA)
- November 1 - Farm Street Opry
- November 2
 - Arbor Day Event at Bob Bryant Park
 - First Friday Art Walk
- November 3 – BCHS Community Wide Garage Sale
- November 6 – ELECTION Day!
- November 7 – Chamber Luncheon
- November 8
 - Capital of Texas Roofing Ribbon Cutting
 - 2nd Annual Boards, Commissions & Volunteer Appreciation Banquet
- November 10 – 13th Annual Veteran's Day Car Show (Thanks Bastrop Area Cruisers)
- November 13 – City Council Meeting



Upcoming Events & City Meetings

- November 14 – Community Support Meeting
- November 15/16 – TML TEDC Training
- November 15 – Special City Council Work Session
- November 19 – BEDC Monthly Meeting
- November 22 – Happy Thanksgiving!
- November 27 – City Council Meeting





STAFF REPORT

MEETING DATE: November 13, 2018

AGENDA ITEM: 4B

TITLE:

Councilmembers' Report

STAFF REPRESENTATIVE:

Lynda Humble, City Manager

POLICY EXPLANATION:

Texas Local Government Code, Section 551.045 – Governing Body of Municipality or County: Reports about Items of Community Interest Regarding Which No Action Will Be Taken:

(a) Notwithstanding Sections 551.041 and 551.042, a quorum of the governing body of a municipality or county may receive from staff of the political subdivision and a member of the governing body may make a report about items of community interest during a meeting of the governing body without having given notice of the subject of the report as required by this subchapter if no action is taken and, except as provided by Section 551.042, possible action is not discussed regarding the information provided in the report.

(b) For purposes of Subsection (a), "items of community interest" includes:

- (1) expressions of thanks, congratulations, or condolence;
- (2) information regarding holiday schedules;
- (3) an honorary or salutary recognition of a public official, public employee, or other citizen, except that a discussion regarding a change in the status of a person's public office or public employment is not an honorary or salutary recognition for purposes of this subdivision;
- (4) a reminder about an upcoming event organized or sponsored by the governing body;
- (5) information regarding a social, ceremonial, or community event organized or sponsored by an entity other than the governing body that was attended or is scheduled to be attended by a member of the governing body or an official or employee of the political subdivision; and
- (6) announcements involving an imminent threat to the public health and safety of people in the political subdivision that has arisen after the posting of the agenda.



STAFF REPORT

MEETING DATE: November 13, 2018

AGENDA ITEM: 4C

TITLE:

City Manager's Report

STAFF REPRESENTATIVE:

Lynda Humble, City Manager

POLICY EXPLANATION:

Texas Local Government Code, Section 551.045 – Governing Body of Municipality or County: Reports about Items of Community Interest Regarding Which No Action Will Be Taken:

(a) Notwithstanding Sections 551.041 and 551.042, a quorum of the governing body of a municipality or county may receive from staff of the political subdivision and a member of the governing body may make a report about items of community interest during a meeting of the governing body without having given notice of the subject of the report as required by this subchapter if no action is taken and, except as provided by Section 551.042, possible action is not discussed regarding the information provided in the report.

(b) For purposes of Subsection (a), "items of community interest" includes:

- (1) expressions of thanks, congratulations, or condolence;
- (2) information regarding holiday schedules;
- (3) an honorary or salutary recognition of a public official, public employee, or other citizen, except that a discussion regarding a change in the status of a person's public office or public employment is not an honorary or salutary recognition for purposes of this subdivision;
- (4) a reminder about an upcoming event organized or sponsored by the governing body;
- (5) information regarding a social, ceremonial, or community event organized or sponsored by an entity other than the governing body that was attended or is scheduled to be attended by a member of the governing body or an official or employee of the political subdivision; and
- (6) announcements involving an imminent threat to the public health and safety of people in the political subdivision that has arisen after the posting of the agenda.



STAFF REPORT

MEETING DATE: November 13, 2018

AGENDA ITEM: 4D

TITLE:

A proclamation of the City Council of the City of Bastrop, Texas recognizing November 5-9, 2018, as Municipal Court Week.

STAFF REPRESENTATIVE:

Kimberly Walters, Administrator
Patsy Paranich, Juvenile Case Manager

BACKGROUND/HISTORY:

Municipal Courts, City Councils, and communities throughout Texas are showing appreciation for the dedicated Municipal Judges, court clerks, court administrators, prosecutors, bailiffs, and warrant officers who comprise the Texas Municipal Courts from November 5-9, 2018. Municipal Court Week is a great time to not only recognize how much municipal courts do, but to share with the public the important role that local courts and their personnel play in the criminal justice system and the community.

ATTACHMENTS:

Proclamation for Municipal Court Week

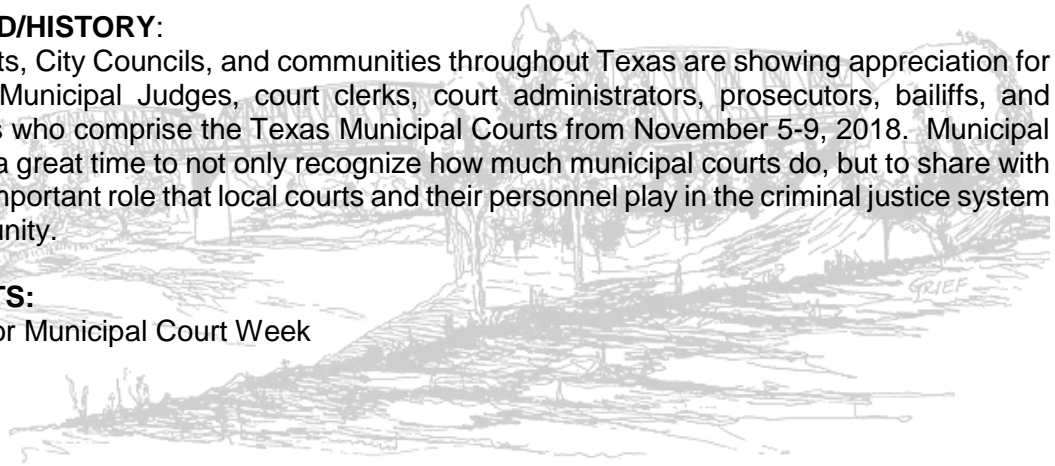

P

ROCLAMATION



WHEREAS, the Municipal Court of the City of Bastrop, a time honored and vital part of local government, has existed since 1832; and

WHEREAS, more people, citizens and non-citizens alike, come in personal contact with municipal courts than all other Texas courts combined; and

WHEREAS, public impression of the entire Texas judicial system is largely dependent upon the public's experience in municipal court; and

WHEREAS, Municipal Judges and court support personnel have pledged to be ever mindful of their neutrality and impartiality, rendering equal service to all, and conform to the standards set by the Canons of Judicial Conduct; and

WHEREAS, the Municipal Courts play a significant role in preserving the quality of life in Texas communities through the adjudication of traffic offenses, ensuring a high level of traffic safety for our citizens; and

WHEREAS, the Municipal Courts serve as the local justice center for the enforcement of local ordinances and fine-only state offenses that protect the peace and dignity of our community; and

WHEREAS, the Municipal Judges and Clerks continually strive to improve the administration of justice through participation in judicial education programs, seminars, workshops and the annual meetings of their state and local professional organizations; and

WHEREAS, it is most appropriate that we recognize the accomplishments of the 916 Texas Municipal Courts, and salute their critical role in preserving public safety, protecting the quality of life in Texas communities, and deterring future criminal behavior.

NOW, THEREFORE, I, Connie Schroeder, Mayor of the City of Bastrop, do hereby proclaim the **5th-9th of November 2018 as Municipal Court Week** and do hereby call upon community members to join us in the recognition of the personnel serving the Bastrop Municipal Court for their vital service and dedication to our community.

IN WITNESS WHEREOF, I have hereunto set my hand and caused the Official Seal of the City of Bastrop, Texas to be affixed this 13th day of November, 2018.

Connie B. Schroeder, Mayor



STAFF REPORT

MEETING DATE: November 13, 2018

AGENDA ITEM: 6A

TITLE:

Receive presentation from Bastrop Housing Authority on their 2018 Annual Report.

STAFF REPRESENTATIVE:

Lynda K. Humble, City Manager

ATTACHMENTS:

- 2017 Annual Audit for Bastrop Housing Authority
- 2017 Annual Report for Bastrop Housing Authority

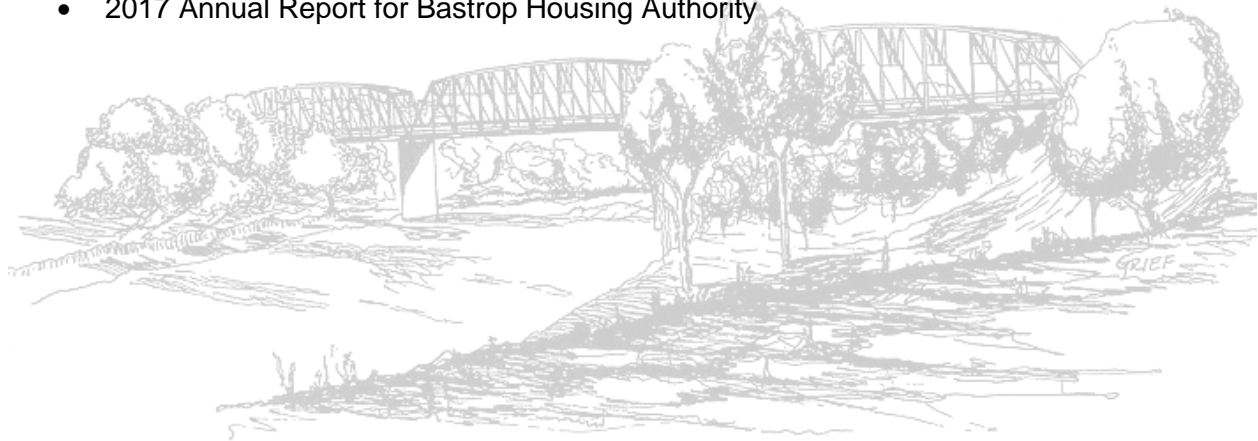

BASTROP HOUSING AUTHORITY ANNUAL REPORT



Fiscal year ending September 30, 2017



Table of Contents

Table of Contents	Page 1
Board of Commissioners	Page 2
Mission Statement	Page 2
Housing Authority Staff	Page 3
Public Housing Program	Page 4
Section 8 New Construction Program	Page 6
Section 8 Housing Choice Voucher Program	Page 7
Waiting List	Page 9
Management Discussion and Analysis	Page 10
Strong Families Initiative Event	Page 17

Supplemental Reports:

Public Housing Assessment System (PHAS) Score Report
Public Housing Physical Inspection Score Report
Piney Creek North Management and Occupancy Review (MOR) Report
Section 8 (HCV) Management Assessment Program (SEMAP) Score Report
Annual Audit for fiscal year ending September 30, 2017



BOARD OF COMMISSIONERS

Phil Woods, Chairperson

Appointed 2002

Carlton Harris, Vice-Chairperson

Appointed 2013 and 2017

Bernie Jackson, Commissioner

Appointed 2017

Debra Thorne-Francis, Commissioner

Appointed 2017

Janie McFarlin, Resident Commissioner

Appointed 2015

MISSION STATEMENT

The Housing Authority of the City of Bastrop is committed to providing quality affordable housing in a suitable living environment to low and moderate income individuals and families without discrimination; and to creating economic opportunities for customers to become self-sufficient.



BASTROP HOUSING AUTHORITY STAFF



Brandy Spencer, Executive Director

Brandy has served as Executive Director of Bastrop Housing Authority since 1993 and is responsible for the overall operations of the Housing Authority.

Angel Cartwright, Housing Representative

Angel worked for Bastrop Housing Authority since 2003 and was primarily responsible Lease Enforcement, Waiting List Management and served as the UPCS Inspector for Public Housing and Piney Creek North and the HQS Inspector for Section 8 HCV Program in addition to other duties. Sadly, after 15 years, Ms. Cartwright decided to leave our agency on August 31, 2018 and will be missed by all.



Geri McCoy, Housing Representative

Geri has worked for Bastrop Housing Authority since 2007. Geri's primary duties are primarily administrative functions involving admission, annual and interim recertifications in addition to various other duties.

Martin Galvan, Maintenance Mechanic

Martin has worked for Bastrop Housing Authority from 2004 to 2012 and returned to work in 2015. Martin is responsible for performing various maintenance-related tasks at all properties and has served as lead maintenance during past physical inspections.



Michael Kresge, Maintenance Mechanic

Michael has worked for Bastrop Housing Authority since 2012. Michael is responsible for performing various maintenance related tasks at all properties and preparing to serve as lead maintenance on the upcoming physical inspection.



PUBLIC HOUSING PROGRAM

Operating funding for the Low Rent Public Housing Program is provided through dwelling rents paid by residents and operating subsidy paid by the US Department of Housing and Urban Development (HUD). The Low Rent Public Housing Program consists of fifty (50) dwelling units scattered at three sites in Bastrop.



Riverview Heights

Riverview Heights is located at Farm and Wilson Streets near Fisherman's Park and consists of 16 dwelling units, or 8 duplexes. This property was built in 1968 and consists of one bedroom units occupied by elderly residents and near-elderly residents, who are aged 55 or older with a disability. The Bastrop Housing Authority's administrative office and the Manor House Community Room are also located at this site. In the last 25 years, Bastrop Housing Authority has served 79 families at this site and the average length of occupancy has been 5 years and 2 months.

Anderson Plaza

Anderson Plaza is located at Hill, Jefferson, Austin and Emile Streets near the softball field and consists of 14 units, or 7 duplexes. The property was built in 1968 and consists of one and two bedroom units occupied by elderly residents and near-elderly residents, who are aged 55 or older with a disability. In the past 25 years, Bastrop Housing Authority has served 48 families at this site and the average length of occupancy has been 8 years, 6 months.



Linden Village



Linden Village is located at Main, Linden and Wilson Streets and consists of 20 units, or 10 duplexes. This property was built in 1968 and consists of two and three bedroom units occupied by families with children as well as elderly and disabled residents. The Bastrop Housing Authority's Maintenance Shop and the Linden Community Space is located at this site. In the past 25 years, Bastrop Housing Authority has served 102 families at this site and the average length of occupancy has been 3 years, 7 months.



PUBLIC HOUSING PROGRAM PERFORMANCE INDICATORS

Public Housing Assessment System (PHAS)

BHA's performance was based on key measures assessed in the categories of Physical, Financial, Management and Capital Fund. The report indicates that historically, BHA has scored exceptionally well. The most recent PHAS Score was a 96 out of a maximum 100 points and Bastrop Housing Authority received a designation of High Performer. The report indicates the following for the PHAS sub-indicators:

Physical

The PHAS physical score is based on the results of inspections by independent contractors working for HUD. BHA's most recent physical inspection for Public Housing was in November 2017 and BHA scored a 97. BHA received 39 of the maximum 40 points for the physical sub-indicator. Properties that score a 90 or above are not assessed in the two years following the inspection.

Financial

BHA received the maximum 25 points for the last three PHAS reports for the financial sub-indicator.

Management

The report indicates that BHA has done an excellent job in collecting rents and maintaining a 100% occupancy rate for the last three years. BHA received 22 points of the maximum 25 points for the management sub-indicator.

Capital Fund

BHA received the maximum 10 points for the last three PHAS reports for the capital fund sub-indicator.



SECTION 8 NEW CONSTRUCTION (Piney Creek North)



Piney Creek North

Piney Creek North is a project-based Section 8 Program consisting of 30 dwelling units, or 15 duplexes located at 2110 N. Main Street. This property was built in 1978 and consists of one, two, three and four bedroom units occupied by families with children as well as elderly and disabled residents. In the past 25 years, Bastrop Housing Authority has served 240 families at this site and the average length of occupancy has been 3years, 4 months.



Piney Creek North was financed through the issuance of bonds and the debt services was paid off in 2008. Bastrop Housing Authority has maintained a Housing Assistance Payments Contract (HAP) with the US Department of Housing and Urban Development (HUD) to supplement the difference in tenant-paid rent and the Contract Rent for these units.

Renovations at this site during FYE 2017 included replacing composition shingle roofs with metal roofs.

PINEY CREEK NORTH PERFORMANCE INDICATORS

HUD contracts with Performance Based Contract Administrators (PBCA's) to perform contract administration for these programs. The contract administrator for Piney Creek North is Southwest Housing Compliance Corporation (SHCC). After 6 years of SHCC not performing Management and Occupancy Reviews (MORs), Bastrop Housing Authority had an MOR in April 2017 and the property's overall MOR rating was Above Average.

Physical

The PHAS physical inspection score is based on the results of inspections by independent contractors working for HUD. BHA's most recent physical inspection at Piney Creek North was conducted in April 2016 and BHA scored a 93. Properties that score a 90 or above are not assessed in the two years following the inspection.



SECTION 8 HOUSING CHOICE VOUCHER PROGRAM (HCV)

The Section 8 Housing Choice Voucher (HCV) Program is a tenant-based Section 8 Program that provides rental assistance to assist up to 22 low-income families, allowing them to be able to afford decent, safe and sanitary housing in the private market. The amount of housing assistance is determined based upon household composition, household income, type of utilities and the size of unit the family is eligible to lease.

Landlords who participate in the HCV Program are required to screen their tenants using the same criteria used for unassisted tenants and HCV program participants must comply with the terms and conditions of the owner's lease agreement which must be the same lease used with unassisted tenants. The landlord is responsible for enforcing the tenant's obligations under their lease and must initiate eviction for non-compliance as they would with other unassisted tenants. Any HCV program participant who is evicted for non-compliance with the lease or that leaves owing any money for rent or damages may also be terminated from the HCV Program. Landlords participating in the HCV Program are required to enter into a Housing Assistance Payments (HAP) Contract with the Housing Authority, agreeing to maintain the unit in accordance with Housing Quality Standards. In exchange, the Housing Authority supplements the difference in the tenant-paid portion of rent and the contract rent.

The Housing Authority receives subsidy for the HCV Program from the US Department of Housing and Urban Development. Subsidy for housing assistance payments is restricted and may only be used to provide housing assistance. The Housing Authority also receives subsidy for administrative costs associated with the HCV Program. The Section 8 HCV program is a budget-based program and subsidy is calculated based on program utilization in the prior year. In recent years, the HCV program has been funded at a proration of actual eligibility. In 2017, subsidy for administrative fees and costs are projected to be funded at a 77% proration and subsidy for housing assistance payments is projected to be funded at 94% proration. Although subsidy has decreased, the costs required to assist program participants has increased. Several factors such as increases in rent and utilities and household composition as well as decreases in household income impacts the amount of housing assistance provided. Bastrop Housing Authority has managed to maintain program utilization at 100% for all 22 vouchers. However, if program expenses exceed available operating subsidy and BHA's reserves at any time in the future, BHA will be required to reduce the number of families served under the program.

Portability

Since the HCV Program is a tenant-based program, the housing assistance is portable. Families may move from one unit to another and the housing assistance moves with them. When the family moves, their existing unit goes off the HCV Program unless another HCV participant leases the unit. Families may also use portability to move to another jurisdiction and take their housing assistance with them. At the end of September 2016, the Housing Authority was assisting an additional 21 families that moved to Bastrop with housing assistance from another agency. Prior to the Bastrop Complex Fires and subsequent natural disasters affecting Bastrop, BHA assisted an average of 45 families under portability. However, lack of available rental housing has resulted in many of these families relocating to different jurisdictions.

SECTION 8 HOUSING CHOICE VOUCHER PROGRAM (HCV)

The Section 8 Housing Choice Voucher (HCV) Program is a tenant-based Section 8 Program that provides rental assistance to assist up to 22 low-income families, allowing them to be able to afford decent, safe and sanitary housing in the private market. The amount of housing assistance is determined based upon household composition, household income, type of utilities and the size of unit the family is eligible to lease.

Landlords who participate in the HCV Program are required to screen their tenants using the same criteria used for unassisted tenants and HCV program participants must comply with the terms and conditions of the owner's lease agreement which must be the same lease used with unassisted tenants. The landlord is responsible for enforcing the tenant's obligations under their lease and must initiate eviction for non-compliance as they would with other unassisted tenants. Any HCV program participant who is evicted for non-compliance with the lease or that leaves owing any money for rent or damages may also be terminated from the HCV Program. Landlords participating in the HCV Program are required to enter into a Housing Assistance Payments (HAP) Contract with the Housing Authority, agreeing to maintain the unit in accordance with Housing Quality Standards. In exchange, the Housing Authority supplements the difference in the tenant-paid portion of rent and the contract rent.

The Housing Authority receives subsidy for the HCV Program from the US Department of Housing and Urban Development. Subsidy for housing assistance payments is restricted and may only be used to provide housing assistance. The Housing Authority also receives subsidy for administrative costs associated with the HCV Program. The Section 8 HCV program is a budget-based program and subsidy is calculated based on program utilization in the prior year. In recent years, the HCV program has been funded at a proration of actual eligibility. In 2017, subsidy for administrative fees and costs are projected to be funded at a 77% proration and subsidy for housing assistance payments is projected to be funded at 94% proration. Although subsidy has decreased, the costs required to assist program participants has increased. Several factors such as increases in rent and utilities and household composition as well as decreases in household income impacts the amount of housing assistance provided. Bastrop Housing Authority has managed to maintain program utilization at 100% for all 22 vouchers. However, if program expenses exceed available operating subsidy and BHA's reserves at any time in the future, BHA will be required to reduce the number of families served under the program.

Portability

Since the HCV Program is a tenant-based program, the housing assistance is portable. Families may move from one unit to another and the housing assistance moves with them. When the family moves, their existing unit goes off the HCV Program unless another HCV participant leases the unit. Families may also use portability to move to another jurisdiction and take their housing assistance with them. At the end of September 2016, the Housing Authority was assisting an additional 21 families that moved to Bastrop with housing assistance from another agency. Prior to the Bastrop Complex Fires and subsequent natural disasters affecting Bastrop, BHA assisted an average of 45 families under portability. However, lack of available rental housing has resulted in many of these families relocating to different jurisdictions.

HCV Homeownership

Although the Section 8 Housing Choice Voucher program is primarily used to provide rental assistance, Housing Authorities are given discretionary authority to allow program participants to use their vouchers for mortgage assistance. Bastrop Housing Authority adopted a Homeownership Policy and 2 of the 22 HCV participants utilized their housing assistance to purchase a home. One of these families sold their home after five years and was able to use the proceeds to purchase a home in Louisiana without requiring further assistance under the program.

SECTION 8 HCV PROGRAM PERFORMANCE INDICATORS

Section 8 Management Assessment Program (SEMAP)

Housing Authorities with fewer than 250 units are assessed under SEMAP every two years. Bastrop Housing Authority’s most recent SEMAP Score was for fiscal year ending September 30, 2016 was 100% based on the following individual SEMAP Performance indicators:

1. Selection from the Waiting List	15 of 15 Maximum Points
2. Reasonable Rent	20 of 20 Maximum Points
3. Determination of Adjusted Income	20 of 20 Maximum Points
4. Utility Allowance Schedule Updated	5 of 5 Maximum Points
5. HQS Quality Control	5 of 5 Maximum Points
6. HQS Enforcement	10 of 10 Maximum Points
7. Expanding Housing Opportunities	5 of 5 Maximum Points
8. Payment Standards	5 of 5 Maximum Points
9. Timely Annual Reexaminations	10 of 10 Maximum Points
10. Correct Tenant Rent Calculations	5 of 5 Maximum Points
11. Pre-Contract HQS Inspections Passed	5 of 5 Maximum Points
12. Annual HQS Enforcement	10 of 10 Maximum Points
13. Lease-Up	20 of 20 Maximum Points

Bastrop Housing Authority’s overall SEMAP Performance Rating for fiscal year ending September 30, 2016 was High.



WAITING LIST

Bastrop Housing closed the waiting lists for all programs in October 2014 and there were 244 applicants on the active waiting list. At the time the waiting list was reopened in October, 2017 and there were 69 applicants remaining on the active waiting list. The average wait time for housing assistance at the family sites was an estimated three to five years and the average wait time at the elderly and near-elderly sites was an estimated four to five years. During fiscal year ending September 30, 2017, the Housing Authority accepted no new applications for any of the housing programs. Of the applicants remaining on the active waiting list during the fiscal year, 10 received housing assistance as follows:

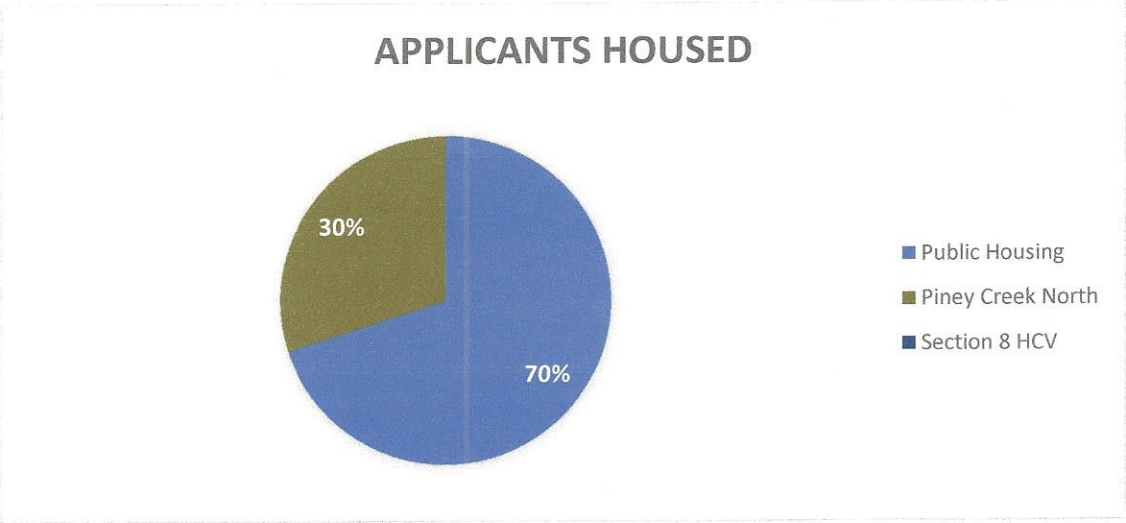

There were 53 applicants removed from waiting list during the fiscal without receiving housing assistance, as follows:

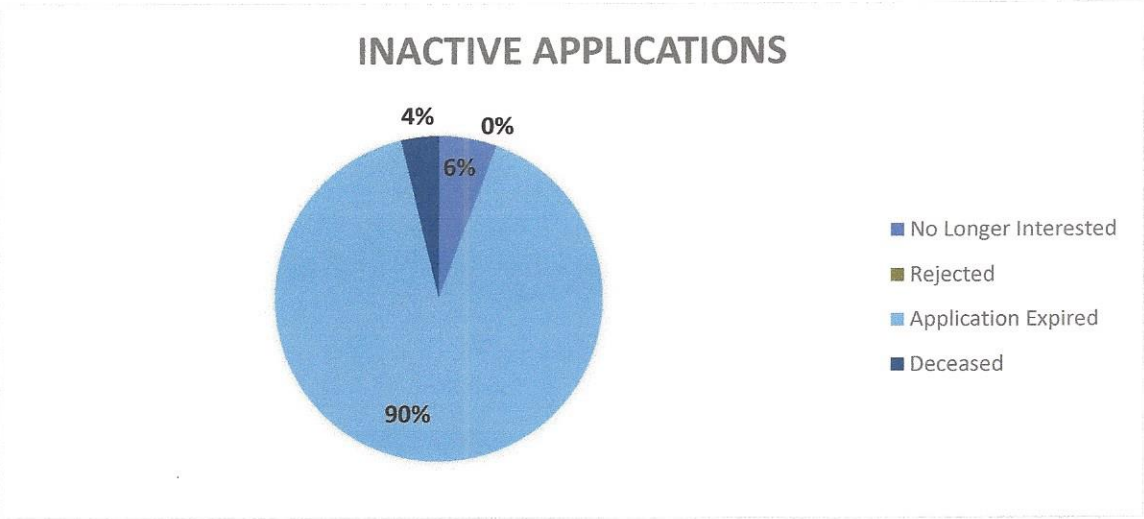

* Note: Applicants are screened for criminal and rental history at initial intake and prior to housing. Since no new applications were accepted during the fiscal year, applicants who failed to meet screening criteria were rejected during the previous fiscal year.



Bastrop Housing Authority Management's Discussion and Analysis For the Year Ended September 30, 2017

Introduction

This Management's Discussion and Analysis (MD&A) of the Bastrop Housing Authority (Authority) provides an introduction and overview to the financial statements of the Bastrop Housing Authority for the fiscal year ended September 30, 2017. The Bastrop Housing Authority presents this discussion and analysis of its financial performance during the fiscal year ended September 30, 2017, to assist the reader in focusing on significant financial issues.

The primary focus of the Authority's financial statements is on the statements of its single enterprise fund encompassing all programs administered by the Bastrop Housing Authority. This information contained herein this MD&A should be considered in conjunction with the Authority's basic financial statements and related notes to the financial statements.

The Authority has five individual programs. They include the Low Rent Public Housing Program, the Capital Fund Program, Housing Choice Voucher Program, the Section 8 New Construction Program, and a State/Local program.

- The Low Rent Program consists of 50 dwelling units. Funding is provided based on dwelling rents paid by the tenants and operating fund payments received by the Department of Housing & Urban Development based on a formula.
- The Capital Fund Program is also a formula based program from HUD. The purpose of this program is to provide funding for the modernization and improvement of the Low Rent Public Housing Program. These resources allow the Housing Authority to provide capital improvements for the current dwelling structures and assist in their operations.
- The Housing Choice Voucher Program provides rental assistance to aid low income families in affording decent, safe and sanitary rental housing. The Authority provides rental assistance in the form of a Housing Assistance Payment to a landlord on behalf of the tenant. The Authority currently has 22 units available. Funds are provided by HUD for rental assistance payments. The Authority is provided an administrative fee for the purpose of covering the administrative costs of the program. The fee is preset by HUD on an annual basis.
- The Section 8 New Construction Program is a 30 unit apartment complex that HUD has entered into a contract to provide Housing Assistance Payments to the Authority for these specific units. Tenants typically pay rent which is 30 percent of the adjusted gross income. The remaining portion of the rent is provided by HUD in the form of rental assistance. The apartment complex was financed through the issuance of bonds.
- The State/Local program consists of DHAP funding that is to be used for disaster related purposes.

Overview of the Financial Statements

This overview of the financial statement is intended to inform and introduce the reader to the Authority's basic financial statements. The basic financial statements are comprised of three individual statements. These statements include:

- The Statement of Net Position
- The Statement of Revenues, Expenses, and Changes in Net Position
- The Statement of Cash Flows

The Statement of Net Position presents information on the assets and liabilities, with the differences between the two being reported as net position. Over time, increases or decreases in net position may serve as a useful indicator of whether the financial situation of the Authority is improving or deteriorating. Net Position is comprised of three individual components:

- *Investment in Capital Assets, Net of Related Debt* consists of capital asset balances net of accumulated depreciation less any outstanding balances of related debt associated with these assets.
- *Restricted Net Position* consists of assets that are restricted by limitations placed on these resources by an external source or party.
- *Unrestricted Component of Net Position* consists of resources that do not meet the definition of the above categories. The unrestricted component of net position are basically the amount of funds available for future year appropriations.

The Statement of Revenues, Expenses, and Changes in Net Position reports the operating revenues, operating expenses, non-operating revenues, and non-operating expenses of the Authority for the fiscal year ended September 30, 2017, to determine the change in Net Position for the fiscal year.

The Statement of Cash Flows reports cash activities for the fiscal year resulting from operating activities, investing activities, non-capital financing activities, and capital and related financing activities. The net result of these activities represents the increase or decrease of the cash equivalent account balance for the year ended September 30, 2017.

Financial Highlights

- The Bastrop Housing Authority's total net position decreased from \$1,803,267 to \$1,667,118, a reduction of \$136,149 or 8%. The total assets decreased by \$131,428, a 7% change.
- The unrestricted net position balance is listed as \$1,144,447 at September 30, 2017. This represents a decrease of \$172,828 or 13% from the previous year.
- Total revenues decreased from \$898,136 to \$841,624, a reduction of \$56,512 or 6%.
- Total expenses increased by \$61,659 from \$916,114 to \$977,773 for the current year. This represents a 7% addition.

Housing Authority Activities & Highlights

The Housing Authority's overall financial position and operations for the past two years are summarized below based on the information in the current and prior financial statements. The table below lists the asset and liability comparisons for the year ended September 30, 2017, and September 30, 2016.

Summary Statement of Net Position

Years Ended September 30, 2017 and 2016

Category	9/30/2017	9/30/2016	Change \$	Change %
Current Assets	\$ 1,188,896	\$ 1,357,288	\$ (168,392)	-12%
Fixed Assets (Net of Depreciation)	\$ 521,671	\$ 484,707	\$ 36,964	8%
Total Assets	\$ 1,710,567	\$ 1,841,995	\$ (131,428)	-7%
Current Liabilities	\$ 38,106	\$ 38,728	\$ (622)	-2%
Total Liabilities	\$ 38,106	\$ 38,728	\$ (622)	-2%
Deferred Inflow of Resources	\$ 5,343	\$ -	\$ 5,343	N/A
Unrestricted	\$ 1,144,447	\$ 1,317,275	\$ (172,828)	-13%
Restricted	\$ 1,000	\$ 1,285	\$ (285)	-22%
Net Investment in Capital Assets	\$ 521,671	\$ 484,707	\$ 36,964	8%
Total Net Position	\$ 1,667,118	\$ 1,803,267	\$ (136,149)	-8%

Current Assets

Current Assets decreased from \$1,357,289 to \$1,188,896, a change of \$168,392 or 12% from September 30, 2016 to September 30, 2017. This decrease is primarily due to a roofing project, ADA renovations, and extraordinary maintenance for asbestos abatement.

Noncurrent Assets

Noncurrent Assets consist of capital assets and are discussed in their respective section.

Current Liabilities

Current Liabilities decreased from \$38,728 to \$38,106, a change of \$622 from September 30, 2016 to September 30, 2017.

Net Position

The Authority's total Net Position balance decreased by \$136,149 from the previous year.

The restricted net position balance changed from \$1,285 to \$1,000, a decrease of \$285 or 22% from September 30, 2016 to September 30, 2017. This change was due to an excess of HAP expenditures of \$157,825 over HAP revenues of \$157,540 for the current year. (This excludes port-in activity.)

The unrestricted net position balance decreased from \$1,317,275 to \$1,144,447 from September 30, 2016 to September 30, 2017. The unrestricted net position account balance is the amount available for future appropriations. This balance is subject to program specific guidelines. Individual program balances are as follows:

Low Rent Housing Program	\$ 225,655
Section 8 Housing Choice Voucher Program:	
- Administrative Funding	32,811
State and Local	0
Section 8 New Construction Program	<u>885,981</u>
Total	\$ <u>1,144,447</u>

Summary Statement of Revenues & Expenses and Changes in Net Position
Years Ended September 30, 2017 and 2016

Category	9/30/2017	9/30/2016	Change \$	Change %
Program Revenues:				
Tenant Revenue	\$ 185,429	\$ 197,756	\$ (12,327)	-6%
Government Operating Grants	\$ 431,187	\$ 408,109	\$ 23,078	6%
Capital Grants	\$ -	\$ 79,185	\$ (79,185)	-100%
Other Revenue	\$ 214,416	\$ 204,634	\$ 9,782	5%
Interest Income	\$ 10,592	\$ 8,452	\$ 2,140	25%
Total Revenue	\$ 841,624	\$ 898,136	\$ (56,512)	-6%
Expenses:				
Administration	\$ 205,552	\$ 191,862	\$ 13,690	7%
Tenant Services	\$ 966	\$ 2,240	\$ (1,274)	-57%
Utilities	\$ 67,492	\$ 62,345	\$ 5,147	8%
Ordinary Maintenance	\$ 186,823	\$ 199,490	\$ (12,667)	-6%
General/Insurance Expense	\$ 38,898	\$ 36,328	\$ 2,570	7%
Nonroutine Maintenance	\$ 37,879	\$ 14,272	\$ 23,607	165%
Depreciation	\$ 85,230	\$ 81,212	\$ 4,018	5%
Housing Assistance Payments	\$ 354,933	\$ 328,365	\$ 26,568	8%
Total Expenses	\$ 977,773	\$ 916,114	\$ 61,659	7%
Excess (Deficiency) Before Special Items	\$ (136,149)	\$ (17,978)	\$ (118,171)	657%
Change in Net Position	\$ (136,149)	\$ (17,978)	\$ (118,171)	657%
Net Position, Beginning of Year	\$ 1,803,267	\$ 1,821,245	\$ (17,978)	-1%
Net Position, End of Year	\$ 1,667,118	\$ 1,803,267	\$ (136,149)	-8%

Results of Operations

Revenues of the Authority are generated principally from dwelling rents and HUD grants (including Operating and Capital Funds). The Authority's revenue decreased by \$56,512 during the current fiscal year. Accounts with notable changes are listed below:

- Capital grants decreased 100% from September 30, 2016 to September 30, 2017 for a total decrease of \$79,185.
- Government operating grants increased \$23,078 or 6% from September 30, 2016 to September 30, 2017. This was primarily due to the Authority drawing down \$22,404 from the capital fund program for operations.
- Interest income increased by \$2,140 or 25%.
- Tenant revenue decreased from \$197,756 to \$185,429, a decrease of \$12,327 from September 30, 2016 to September 30, 2017. This is primarily due to average month rent decreasing from \$385 in 2016 to \$370 in 2017 and average occupancy rate decreasing from 98% to 91% primarily due to mold and asbestos abatements and ADA renovations.

Total expenses increased by \$61,659. Significant differences between the years include the following:

- Administration increase by \$13,690 or 7%. This was primarily due to advertising and marketing increasing by \$6,466, travel increasing by \$3,488, and employee benefits increasing by \$2,459.
- Ordinary maintenance decreased by \$12,667 or 6%. This was primarily due to a decrease in maintenance materials of \$13,139.
- Nonroutine maintenance increased by 165% or \$23,607 due to environmental testing for mold and asbestos abatement and restoration for apartments.
- Housing assistance payments increased by \$26,568 or 8%. This was primarily due to average monthly rent increasing from \$571 to \$590 and unit months leased increasing from 258 to 268.



We have provided the following presentations to demonstrate the revenues and expenses by summarized account category:

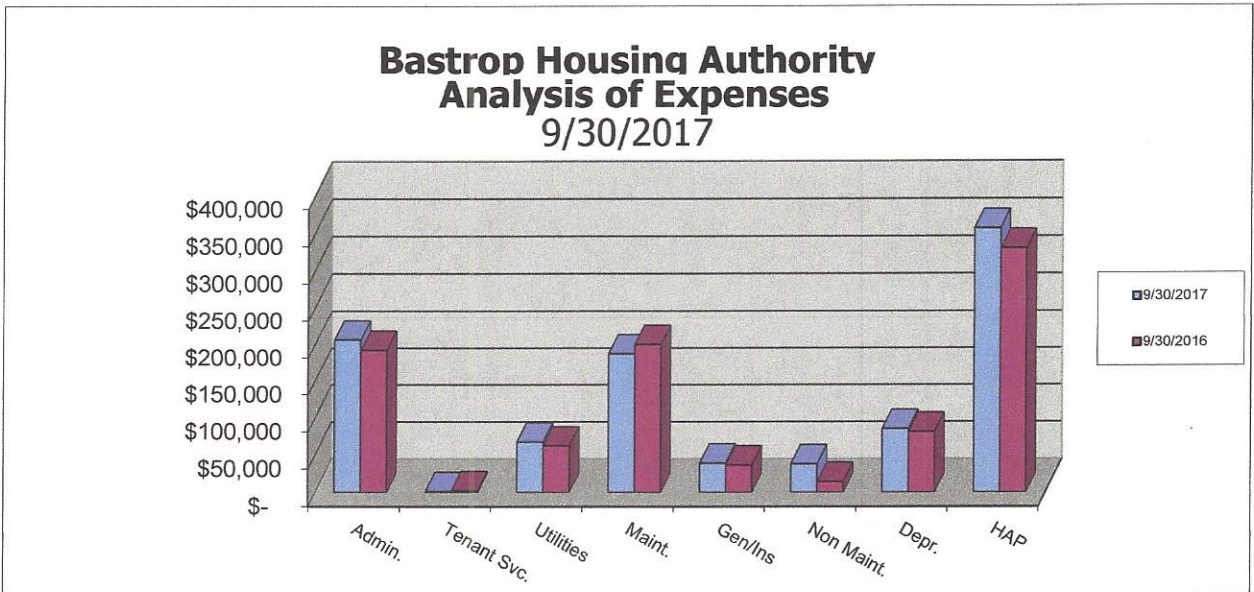
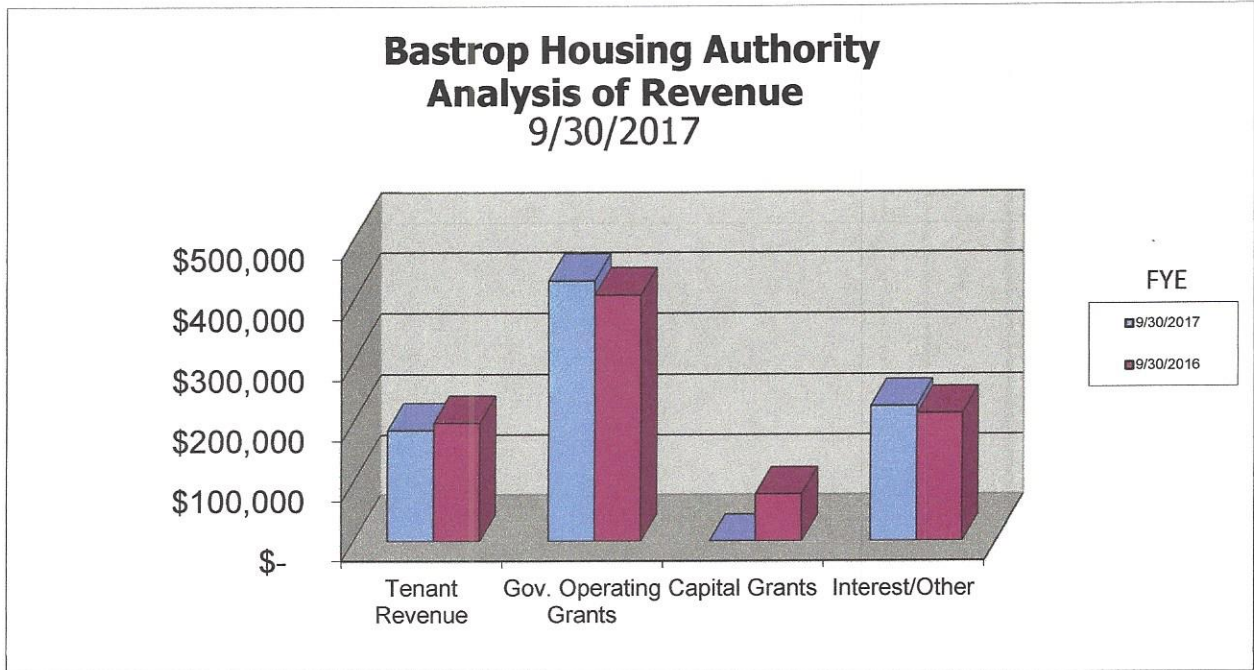

Capital Assets

As of September 30, 2017, the Bastrop Housing Authority’s Investment in Capital Assets was \$521,671. This investment includes land, buildings, construction in progress, and equipment net of accumulated depreciation.

Summary Statement of Capital Assets
Years Ended September 30, 2017 and 2016

<u>Category</u>	<u>9/30/2017</u>	<u>9/30/2016</u>	<u>Change \$</u>	<u>Change %</u>
Land	\$ 48,040	\$ 48,040	\$ -	0%
Buildings	\$ 3,732,322	\$ 3,619,701	\$ 112,621	3%
Equipment	\$ 387,392	\$ 380,793	\$ 6,599	2%
Construction in Progress	\$ 5,010	\$ 2,034	\$ 2,976	146%
Accumulated Depreciation	\$ (3,651,093)	\$ (3,565,861)	\$ (85,232)	2%
Total Net Fixed Assets	\$ 521,671	\$ 484,707	\$ 36,964	8%

Subsequent Events

Due to the 2018 Congressional Appropriations, the Authority’s operating subsidy provided by HUD for the Low Rent Housing Program is estimated to be 92% for the calendar year 2018.

The amount of funding for the 2018 calendar year for the Housing Choice Voucher Program will include the proration of administrative fees at an estimated 77.988% and HAP funding at 100%.

Capital fund improvements will include roof replacement at Riverview Heights and Anderson Plaza. Other needed capital improvements needed are dwelling unit improvements including abatement of sheetrock and vinyl composition tile and window replacement which will require multiple years of capital funding to complete. We have concerns about the proposed elimination of the capital fund program and proposed reductions in operating subsidies due to the impact this will have on operations.

Request for Information

This financial report is designed to provide a general overview of the Authority’s accountability for all those interested. If you should have additional questions regarding the financial information, you can contact our office in writing at the following address:

Bastrop Housing Authority
 Brandy Spencer, Executive Director
 PO Box 707
 Bastrop, TX 78602



STRONG FAMILIES INITIATIVE

On July 27, 2018, Bastrop Housing Authority hosted our first annual Strong Families Initiative event. This event was held to strengthen, empower and improve the quality of life for families living in our HUD-assisted housing programs by providing fathers, mothers and youth with access to local resources for health, education and economic empowerment.

BHA’s Strong Families Initiative was held in conjunction with Friendship Bible Baptist Church’s celebration for the end of their Summer Meal Program, which provided nutritious hot meals for breakfast and lunch during the summer. Friendship Bible Baptist Church (FBBC), in partnership with Central Texas Food Bank, the YMCA and Texas AgriLife Extension Service, also offered additional fun activities, including Vacation Bible School, gardening, games, field trips and swim lessons for youth that wished to remain at the site between meals.

The following agencies provided information on resources and services during the event:

- AGI Life Insurance
- *Bastrop County Emergency Food Pantry
- * Bastrop Housing Authority
- *Bastrop Pregnancy Resource Center
- *Bastrop ISD
- *Blue Cross, Blue Shield of Texas
- Children’s Advocacy Center
- *Community of Hope
- *Texas Hunger Initiative
- *Dell Children’s Health Plan
- Friendship Bible Baptist Church
- *Hunger Free Communities-Bastrop
- *YMCA
- ITS HUH/Open Door Soup Kitchen
- *Little Club House Academy Day Care
- *Seton RX Help
- Texas HHSC
- *Texas Workforce Commission

** Agencies that set up booths and made representatives available to answer questions*

Meals were donated by:

Chicken Express Southside Market Billy’s Bar-b-Que Chic-Fil-A (gift cards)

Drinks/ice were donated by:

Family Crisis Center Texas Hunger Initiatives ITS-HUH/Open Door Soup Kitchen

Entertainment was donated by Bastrop Housing Authority

Large water slide Small water slide/Bounce House Combo DJ Flaco

Prizes and Giveaways

Bastrop First Assembly of God received a donation of 554 pair of new shoes from Buckner International and One Life One World International that were distributed to adults and children during the event. Additionally, Friendship Bible Baptist Church and Hunger Free Communities gave other goodies such as tooth brushes, tooth paste and coloring activities.



Bspencer

From: phas@hud.gov
Sent: Thursday, February 08, 2018 8:46 PM
To: b_spencer@austin.rr.com
Cc: Gordon.J.Tabone@hud.gov; TOMAS.M.ROMERO@hud.gov;
Genoveva.C.Loran@hud.gov; JOSEPH.A.UVIEDO@hud.gov; David.G.Pohler@hud.gov;
SAN_Public_Housing@hud.gov
Subject: High Performer Notification - TX259 09/30 2017
Attachments: PHAScoreReport.PDF

Dear Executive Director:

This letter is to advise you that the Public Housing Assessment System (PHAS) score and designation for your public housing agency (PHA) has been issued for the fiscal year end stated in the above subject line.

For your convenience a score report is attached. You are encouraged to login to HUD's Secure Systems for the most recent scoring information; to review the Assessment Status Report; and to monitor the status of your assessments.

If you believe that an objectively, verifiable, and material error occurred in the scoring and that correcting it will change the PHAS designation, you may submit an appeal request pursuant to 24 CFR 902.69. For prompt delivery and assurance it is received within the prescribed timeline, it is suggested that you submit the appeal through the request tab in Secure Systems. If you prefer you may submit the appeal to:

Mr. Donald J. Lavoy
Deputy Assistant Secretary
U.S. Department of Housing and Urban Development
Real Estate Assessment Center
550 12th Street S.W.
Suite 100
Washington, DC 20410

Please refrain from sending the request through more than one method.

Should you have any questions, please email us at PHAS@hud.gov or contact the Technical Assistance Center (TAC) at 1-888-245-4860, Monday through Friday from 7:00am to 8:30pm Eastern Time.

DEEANN WALKER
PROGRAM MANAGER, INTEGRATED ASSESSMENT SUBSYSTEM



U.S. Department of Housing and Urban
OFFICE OF PUBLIC AND INDIAN HOUSING
REAL ESTATE ASSESSMENT CENTER

Public Housing Assessment System (PHAS) Score Report for Interim Rule

Report Date: 02/08/2018

PHA Code:	TX259
PHA Name:	Bastrop Housing Authority
Fiscal Year End:	09/30/2017

PHAS Indicators	Score	Maximum Score
Physical	39	40
Financial	25	25
Management	22	25
Capital Fund	10	10
Late Penalty Points	0	
PHAS Total Score	96	100
Designation Status:	High Performer	
Published 02/08/2018	Initial published	02/08/2018

Financial Score Details	Score	Maximum Score
Unaudited/Non Single Audit		
1. FASS Score before deductions	25.00	25
2. Audit Penalties	0.00	
Total Financial Score Unrounded (FASS Score - Audit Penalties)	25.00	25

Capital Fund Score Details	Score	Maximum Score
Timeliness of Fund Obligation:		
1. Timeliness of Fund Obligation %	90.00	
2. Timeliness of Fund Obligation Points	5	5
Occupancy Rate:		
3. Occupancy Rate %	100.00	
4. Occupancy Rate Points	5	5
Total Capital Fund Score (Fund Obligation + Occupancy Rate):	10	10

Notes:

- The scores in this Report are the official PHAS scores of record for your PHA. PHAS scores in other systems are not to be relied upon and are not being used by the Department.
- Due to rounding, the sum of the PHAS indicator scores may not equal the overall PHAS score.
- "0" FASS Score indicates a late presumptive failure. See 902.60 and 902.92 of the Interim PHAS rule.
- "0" Total Capital Fund Score is due to score of "0" for Timeliness of Fund Obligation. See the Capital Fund
- PHAS Interim Rule website - <http://www.hud.gov/offices/reac/products/prodphasinrule.cfm>

Bspencer

From: reac_pass@hud.gov
Sent: Monday, November 13, 2017 12:34 PM
To: b_spencer@austin.rr.com
Cc: phas.corr@hud.gov; REACReverseAuctionProgram@hud.gov; reac_pass@hud.gov; Gordon.J.Tabone@hud.gov; TOMAS.M.ROMERO@hud.gov; Genoveva.C.Loran@hud.gov; JOSEPH.A.UVIEDO@hud.gov; David.G.Pohler@hud.gov; SAN_Public_Housing@hud.gov; phas.corr@hud.gov; REACReverseAuctionProgram@hud.gov; reac_pass@hud.gov
Subject: Physical Inspection Released for PHA - TX259

11/13/2017
Bastrop
POBox 707
BASTROP TX 78602

Dear Sir/Madam:

The Inspection Summary Report is now available for the below property in your housing authority.

Inspection Id: 607948
Development No: TX259000001
Property Name: ANDERSON,LINDEN,RIVERVIEW

Please review the report by logging into HUDs Intranet, referred to as "Secure Systems." The website address is: <http://www.hud.gov/offices/reac/online/reasyst.cfm>. Once you have logged into Secure Systems, select the "Public Housing Assessment Subsystem: Scores and Status (NASS)" link. From this screen, 1) enter your PHA Code, 2) select the appropriate Fiscal Year, 3) select the "Physical Indicator Score" option, and 4) click on the "Submit" button. At this point, you will be able to select the individual "Project ID" link to view the report.

Technical Review/Database Adjustment Information:

If you believe that certain inspection data may have been recorded in error, you may request a technical review or a database adjustment appeal of the physical inspection score. However, a request for a technical review or database adjustment can only be made for errors that, if corrected, will result in a significant improvement in the property's overall score.

A technical review may be requested if, following a review of the physical inspection results and score, an objectively verifiable and material error(s) occurred in the inspection that, if corrected, will result in a significant improvement in the property's overall inspection score. Only those issues that are material will be considered for a technical review. A technical review appeal addresses:

- * Building data errors;
- * Unit count errors; and
- * Non-existent deficiency errors.

A database adjustment examines the results of a physical inspection that are out of the ordinary or incorrect due to circumstances affecting the inspected property, which are not reflected or inappropriately reflected in

the physical condition score. Circumstances that may be addressed by a database adjustment are:

- * Local conditions and code exceptions;
- * Ownership issues for a deficiency;
- * Adverse conditions beyond the control of the owner; and
- * Extensive modernization work in progress.

Requests for both technical reviews and database adjustments must be material, objectively verifiable, include supporting documentation, and made in writing within the appropriate time period. PHAs must send each request and must be received at REAC within 30 days following PIH-REACs issuance of the electronic Inspection Summary Report to the PHA. Database adjustment appeals should be sent and must be received by the local HUD field office within 45 days following PIH-REACs issuance of the electronic inspection summary report to the PHA. Address information for each field office may be accessed at <http://www.hud.gov/localoffices.cfm>. Technical review appeals should be sent directly to PIH-REAC at the following mailing address:

U.S. Department of Housing and Urban Development
Office of Public and Indian Housing - Real Estate Assessment Center
Attn: PASS Technical Reviews and Database Adjustments
550 12th Street S.W., Suite 100
Washington, D.C. 20410

For more information, PIH-REAC has provided technical review guidelines in the Federal Register at 24 CFR Part 902.68, and online at http://www.hud.gov/offices/reac/products/pass/pass_guidelines.cfm. Guidelines for requesting a database adjustment are available in the Federal Register at 24 CFR Part 902.25(c), and online at http://www.hud.gov/offices/reac/products/pass/pass_database_adjustment.cfm.

If you have any questions, please call the PIH-REAC Technical Assistance Center (TAC) at 1-888-245-4860 between 7:00 AM and 8:30 PM Eastern Standard Time.

Sincerely,

SAMUEL TUFFOUR
PROGRAM MANAGER, PHYSICAL ASSESSMENT SUBSYSTEM

Inspection Summary Report (POA) for Inspection #607948

Score Summary					
Area	Possible Points	Deductions(Excluding H&S)	Pre H&S Points	H&S Deductions	Final Points
Site	17.40	0.00	17.40	0.00	17.40
Building Exterior	18.43	0.00	18.43	0.00	18.43
Building Systems	14.05	0.00	14.05	0.00	14.05
Common Area	0.95	0.00	0.95	0.00	0.95
Unit	49.17	0.96	48.21	2.17	46.04
Total	100.00	0.96	99.04	2.17	96.87

Score Version: 1

Score Date: 11/09/2017

Final Score: 97b



A Subsidiary of the Housing Authority of the City of Austin

May 3, 2017

Transmitted Via Email

The Housing Authority Of The City Of Bastrop, Texas
Brandy Spencer, Executive Director
P.O. Box 707, 502 Farm Street
Bastrop , TX 78602

RE: Piney Creek North Apartments / TX590009047

Dear Ms. Spencer,

Enclosed you will find your Management and Occupancy Review (MOR) Summary Report for the above referenced property. It includes a list of Observations, Errors, and Findings resulting from the MOR. Each Error and/or Finding will indicate a corrective action due date of 30 calendar days for each item needing correction. Properties with Errors and/or Findings will be placed on a monitoring status pending receipt of a complete corrective action response. If you do not have any Errors or Findings, no response is required.

Based on our observations and document analysis, your property's overall MOR Rating is: Above Average

For those properties receiving a rating of Below Average or Unsatisfactory on any specific category or on the overall rating on your HUD Form 9834 Summary Report page, you have a right to appeal your rating. Any appeal must be submitted in writing to Michael Cummings, Vice President, at the address listed below. Your written appeal must be postmarked within 30 days of this letter and must explain the factual basis for a change in rating, with specific examples provided. Mr. Cummings will review the appeal and determine whether the rating(s) should stand or be revised. If we are not in receipt of your written appeal within the allotted timeframe, you will forfeit your right to an appeal. The correction of other deficiencies which you do not dispute in your appeal must still be provided within the original 30 calendar day deadline. HUD Handbook 4350.1 Rev-1, Chapter 6 provides further guidance on the owner/agent appeal process.

Thank you for the time and effort your staff committed to this review. If you wish to discuss the report prior to preparing your response, please feel free to contact me at the number listed below.

Respectfully,

Zac Daywood
Compliance Specialist

Attachment: HUD Form 9834- Summary Report

...

1124 South IH 35, Austin, Texas 78704
phone 512.474.5332 • fax 512.437.3882 • TTY 800.735.2988
www.shccnet.org

...

For Clarification:

In order to help you better understand the HUD Form 9834, we would like to provide an explanation of the terms we use to evaluate your property. On the MOR Summary Report there are three assessment columns for each numbered item, **A** (Acceptable), **C** (Corrective Action Required) and **TCD** (Target Completion Date). These assessments determine whether an issue will be classified as an **Observation, Error** or **Finding** in the Summary Report - Findings section.

Any numbered item marked as **"A"** is acceptable and no action is required by the owner/agent. Any numbered item marked as **"C"** requires Corrective Action and represents either an **Error** or a **Finding**.

Errors generally concern non-systemic deficiencies in the form of Housing Assistance Payment (HAP) calculation errors. **Errors** must generally be corrected within 30 days and repayment to tenant or HUD (if applicable) must be made within 60 days. **Findings** address other areas of non-compliance, and are typically more serious, systemic issues that need prompt correction. Generally, **TCDs** of 30 days will be issued for **Findings**.

Corrective Action Requirements will always follow **Errors and Findings**. Management must complete the Corrective Action Requirements and send required documentation of appropriate corrective action to your Asset Management Team within the timeframe specified by the **TCD**. Such written responses must be provided on company letterhead and must address each **Error** or **Finding** individually.

Observations will also be issued but will not be denoted by a designation in the Summary Report. **Observations** will be issued in instances where the reviewer feels improvement may be necessary based on industry standards or practices, but does not represent an issue that requires immediate action. In these instances, the **Observation** will be followed by a Recommendation. Management should strongly consider Recommendations but there is no written response required. **Recognitions** will also be issued to recognize exemplary owner/agent action in certain areas.

...

...

PURPOSE: To assess management and oversight of multifamily housing projects.

INSTRUCTIONS: This form is to be completed by HUD staff, Performance Based Contract Administrators/Traditional Contract Administrators (CAs) and Mortgagees of Coinsured Projects (Mortgagees). The Management Review form consists of three parts: Desk Review, On-site Review with Addendums, and Summary Report. All Reviewers of subsidized projects must complete all Addenda (A, B, C & D). Reviewers of unsubsidized projects must complete Addendums B & C only. If any questions on any given form are not relevant to the program under review or if the information is not available, notate with "N/A". FHEO staff provide MFH staff a list of requests for documents and special observations each year. Additional guidance regarding the management process can be found in HUD Handbooks 4350.1, REV-1 and 4566.2.

A. Prior to On-Site Review

Complete Part I – Desk Review

- To complete the Desk Review worksheet prior to the on-site visit, review the project files, system reports, other documents, and contact the HUD representative for any unavailable information needed to complete the desk review. This portion of the review will assist the Reviewer in identifying potential problem areas. HUD staff must complete the entire Desk Review for subsidized projects. For unsubsidized projects, HUD staff/mortgagees must complete all applicable sections. CAs must complete the entire Desk Review except where noted "This question applies only to HUD Staff/Mortgagees."
- Schedule a date for the on-site review with the owner/agent and confirm the review date in writing. The owner/agent should be given at least a two-week notice in writing and notified of the documents that need to be available the day of the review, as specified in Addendum C. Addendum C provides a list of documents notated by the Reviewer that the owner/agent must have available during the on-site review. Addendum C and Part A of Addendum B must be forwarded to the owner/agent with the letter confirming the scheduled on-site review. The Reviewer may request additional items as necessary.

B. Conducting the On-Site Review

Complete Part II – On-Site Review

- On-Site Reviews will be completed as follows:
 - HUD staff and Mortgagees must complete all applicable questions in Part II.
 - CAs must complete all questions in Part II except where noted "This question applies only to HUD staff/Mortgagees."
 - HUD staff completing a review of a project which is also reviewed by a CA will only complete questions not applicable to CAs.
- Use additional sheets as necessary to complete applicable questions.
- Upon completion of the on-site review, the Reviewer will hold a close-out session with the owner/agent to discuss observations and conclusions.

C. After On-Site Review

- The Reviewer will record deficiencies, findings and corrective actions. Findings must include the condition, criteria, cause, effect and required corrective action. The condition describes the problem or deficiency. The criteria should cite the statutory, regulatory or administrative requirements that were not met. The cause explains why the condition occurred. The effect describes what happened because of the condition. The corrective action provides what the owner/agent must do to eliminate the deficiency. The corrective action must include a requirement that the owner determine and correct not only the discovered errors and omissions, but also describe to the reviewer how and what systems, controls, policies and procedures were adjusted or changed to assure that the errors and omissions do not reoccur. In completing the Report of Findings, the Reviewer should also indicate the target completion date.
- The reviewer retrieves Addendum B and forwards the completed form to FHEO, along with the approved initial or updated Affirmative Fair Housing Marketing Plans in accordance with "General Operational Procedures for the Civil Rights Front-End and Limited Monitoring Reviews of Subsidized Multifamily Housing Projects", which may be found on FHEO's web site.
- Complete Summary Report as follows:

Based on the Report of Findings, the Reviewer will assess the overall performance for each applicable category. The Reviewer must indicate A (Acceptable) or C (Corrective action required) and include target completion dates (TCD) for all corrective action items. For those items not applicable, indicate "N/A" in the TCD column.

For each of the seven major categories (*A, B, C, D, E, F, and G*), rate each category by entering a score between 1 and 100. If a category was not reviewed, enter a score of zero (0). After rating the individual categories, an overall rating must be assessed. This rating should be based upon the ratings assigned in categories A through G. CAs will rate all sections except Category D. Category D is for HUD staff and Mortgagees only. Additional guidance for ratings can be found in HUD Handbook 4350.1, REV-1.

- Distribute the Summary Report and cover letter as follows:
 - Project Owner (original)
 - Management Agent (copy)
 - HUD office for PBCA reviews rated below average or unsatisfactory
 - HUD office for all traditional CA reviews.

*A copy of the completed Management Review Report, form HUD-9834 and supporting documents must be maintained in the project file.

- If a below average or unsatisfactory rating is determined, the owner/agent must be afforded an opportunity to appeal. Guidance on appeal procedures is provided in HUD Handbook 4350.1, REV-1.
- All Secure Systems users must document all required data in the Integrated Real Estate Management System (iREMS).

D. Management Review Deficiency Follow up:

- Reviewer must conduct follow-up activity until all corrective actions as required in the Summary Report have been completed. Enter applicable close-out dates in iREMS.
- Housing reviewers will Forward all completed FHEO checklists and attachments to FHEO within five (5) business days of their own on-site reviews or within 5 business days of receipt of the checklists from the CA, as applicable. Follow-up instructions may be found of FHEO's web site.

NOTE: The Fair Housing and Equal Opportunity (FHEO) checklist has been included as part of this management review form; however no determination of compliance with applicable Fair Housing laws and regulations is included in the summary report. CAs must forward the original checklist (Addendum B) to HUD staff. HUD staff must maintain the original checklist in the project file and forward a copy to the Office of FHEO in the appropriate jurisdiction for review.

Management Review for Multifamily Housing Projects

U.S. Department of Housing and Urban Development
Office of Housing – Federal Housing Commissioner

OMB Approval No. 2502-0178
Exp. 4/30/2018

Summary

Date of On-Site Review: 4/7/2017	Date of Report: 5/3/2017	Project Number: 800021240	Contract Number: TX590009047
Section of the Act: 88 NC	Name of Owner: The Housing Authority of the City of Bastrop, Texas	Project Name: Piney Creek North Apartments	Project Address: 2110 Main Street Bastrop, Texas 78602
Loan Status: <input type="checkbox"/> Insured <input type="checkbox"/> HUD-Held <input checked="" type="checkbox"/> Non-Insured <input type="checkbox"/> Co-Insured	Contract Administrator: <input type="checkbox"/> HUD <input type="checkbox"/> CA <input checked="" type="checkbox"/> PBCA	Type of Subsidy: <input checked="" type="checkbox"/> Section 8 <input type="checkbox"/> PAC <input type="checkbox"/> Section 236 <input type="checkbox"/> Section 221(d)(3) BMIR <input type="checkbox"/> Rent Supplement <input type="checkbox"/> RAP <input type="checkbox"/> PRAC <input type="checkbox"/> Unsubsidized	Type of Housing: <input checked="" type="checkbox"/> Family <input type="checkbox"/> Disabled <input type="checkbox"/> Elderly <input type="checkbox"/> Elderly/Disabled <input type="checkbox"/> Other (please specify)

For each applicable category, assess the overall performance by checking the appropriate column. Indicate A (Acceptable) or C (Corrective action required). Include target completion dates (TCD) for all corrective action items. For those items not applicable, place N/A in the TCD column.

A. General Appearance and Security	A	C	TCD	Enter a score between 1 and 100 for the General Appearance and Security Rating. If this Section was not reviewed, enter 0. 95 is 10% of the overall score. This category is rated Superior
1. General Appearance	<input checked="" type="checkbox"/>	<input type="checkbox"/>		
2. Security	<input checked="" type="checkbox"/>	<input type="checkbox"/>		
B. Follow-up and Monitoring of Project Inspections	A	C	TCD	Enter a score between 1 and 100 for the Follow-up and Monitoring of Project Inspections Rating. If this Section was not reviewed, enter 0. 75 is 10% of the overall score. This category is rated Satisfactory
3. Follow-Up and Monitoring of Last Physical Inspection and Observations	<input type="checkbox"/>	<input checked="" type="checkbox"/>	30 Days	
4. Follow-Up and Monitoring of Lead-Based Paint Inspection	<input checked="" type="checkbox"/>	<input type="checkbox"/>		
C. Maintenance and Standard Operating Procedures	A	C	TCD	Enter a score between 1 and 100 for the Maintenance and Standard Operating Procedures Rating. If this Section was not reviewed, enter 0. 85 is 10% of the overall score. This category is rated Above Average
5. Maintenance	<input checked="" type="checkbox"/>	<input type="checkbox"/>		
6. Vacancy and Turnover	<input checked="" type="checkbox"/>	<input type="checkbox"/>		
7. Energy Conservation	<input checked="" type="checkbox"/>	<input type="checkbox"/>		
D. Financial Management/Procurement	A	C	TCD	Enter a score between 1 and 100 for the Financial Management/Procurement Rating. If this Section was not reviewed, enter 0. 0 is 25% of the overall score. This category is rated N/A
8. Budget Management	<input type="checkbox"/>	<input type="checkbox"/>	N/A	
9. Cash Controls	<input type="checkbox"/>	<input type="checkbox"/>	N/A	
10. Cost Controls	<input type="checkbox"/>	<input type="checkbox"/>	N/A	
11. Procurement Controls	<input type="checkbox"/>	<input type="checkbox"/>	N/A	
12. Accounts Receivable/Payable	<input type="checkbox"/>	<input type="checkbox"/>	N/A	
13. Accounting and Bookkeeping	<input type="checkbox"/>	<input type="checkbox"/>	N/A	
E. Leasing and Occupancy	A	C	TCD	Enter a score between 1 and 100 for the Leasing and Occupancy Rating. If this Section was not reviewed, enter 0. 78 is 25% of the overall score. This category is rated Satisfactory
14. Application Processing/ Tenant Selection	<input type="checkbox"/>	<input checked="" type="checkbox"/>	30 Days	
15. Leases and Deposits	<input checked="" type="checkbox"/>	<input type="checkbox"/>		
16. Eviction/Termination of Assistance Procedures	<input checked="" type="checkbox"/>	<input type="checkbox"/>		
17. Enterprise Income Verification (EIV) System Access and Security Compliance	<input checked="" type="checkbox"/>	<input type="checkbox"/>		
18. Compliance with Using EIV Data and Reports	<input type="checkbox"/>	<input checked="" type="checkbox"/>	30 Days	
19. Tenant Rental Assistance Certification System (TRACS) Monitoring and Compliance	<input checked="" type="checkbox"/>	<input type="checkbox"/>		
20. TRACS Security Requirements	<input checked="" type="checkbox"/>	<input type="checkbox"/>		
F. Tenant/Management Relations	A	C	TCD	Enter a score between 1 and 100 for the Tenant Services Rating. If this Section was not reviewed, enter 0. 78 is 10% of the overall score. This category is rated Satisfactory
21. Tenant File Security	<input checked="" type="checkbox"/>	<input type="checkbox"/>		
22. Summary of Tenant File Review	<input type="checkbox"/>	<input checked="" type="checkbox"/>	30 Days	
23. Tenant Grievances	<input checked="" type="checkbox"/>	<input type="checkbox"/>		
24. Provision of Tenant Services	<input checked="" type="checkbox"/>	<input type="checkbox"/>		
G. General Management Practices	A	C	TCD	Enter a score between 1 and 100 for the General Management Practices Rating. If this Section was not reviewed, enter 0. 80 is 10% of the overall score. This category is rated Above Average
25. General Management Operations	<input checked="" type="checkbox"/>	<input type="checkbox"/>		
26. Owner/Agent Participation	<input type="checkbox"/>	<input type="checkbox"/>	N/A	
27. Staffing and Personnel Practices	<input checked="" type="checkbox"/>	<input type="checkbox"/>		

Overall Rating: Superior Above Average Satisfactory Below Average Unsatisfactory Overall Score: 81

To calculate an overall score: Multiply the derived performance value by the assigned percentage of the overall rating for each category. Once all tested categories have been calculated based on the performance indicator and performance indicator values, the total calculated points is divided by the total percentage of overall rating and rounded to the nearest whole number. For convenience, a utility is included with this form which will perform all of the necessary calculations.

Name and Title of Person Preparing this Report: (Please type or print): Zachary Daywood, Compliance Specialist	Name and Title of Person Approving this Report: (Please type or print): Nicholas Vranes, Compliance Manager
Signature: Zachary Daywood Digitally signed by Zachary Daywood DN: cn=Zachary Daywood, o=SHCC, ou, email=zacharyd@shccnet.org, c=US Date: 2017.05.03 11:42:25 -05'00'	Signature: Nicholas Vranes Digitally signed by Nicholas Vranes Date: 2017.05.03 13:33:16 -05'00'

NOTE: If this review is conducted by a CA or PBCA as indicated above, the overall rating reflects a review as it relates to compliance with the Housing Assistance Payment Contract (HAP) only.

**Management Review for
Multifamily Housing Projects**

U.S. Department of Housing and Urban Development
Office of Housing – Federal Housing Commissioner

OMB Approval No. 2502-0178
Exp. 4/30/2018

Summary

SUMMARY REPORT – FINDINGS

For each “C” item checked on the summary report, reference the appropriate citing, and target completion date. Findings must include the condition, criteria, cause, effect and required corrective action:

- o The condition describes the problem or deficiency
- o The criteria cites the statutory, regulatory or administrative requirements that were not met
- o The cause explains why the condition occurred
- o The effect describes what happened because of the condition

Corrective actions are required for all findings.

Item Number	Finding	Target Completion Date
A. General Appearance and Security	No Findings / Observations in this category.	
B. Follow-up and Monitoring of Project Inspections	<p>Finding #1 - B.3</p> <p>Condition: The following unit deficiencies were identified in the REAC inspection on 4/29/2016 and were found to be uncorrected or had reoccurred ahead of the Site Visit.</p> <ul style="list-style-type: none"> • Unit 7 – Rear entry door shows daylight • Unit 11 – Entry door in living area shows daylight <p>Criteria: 24 CFR 5.703: <i>“Physical condition standards for HUD housing that is decent, safe, sanitary and in good repair (DSS/GR)... (d) “Dwelling units. (1) Each dwelling unit within a building must be structurally sound, habitable, and in good repair. All areas and aspects of the dwelling unit (for example, the unit’s bathroom, call-for-aid (if applicable), ceiling, doors, electrical systems, floors, hot water heater, HVAC, kitchen, lighting, outlets/switches, patio/porch/balcony, smoke detectors, stairs, walls, and windows) must be free of health and safety hazards, functionally adequate, operable, and in good repair...”</i></p> <p>Cause: The condition occurred because the deficiencies listed above were identified during the Site Visit.</p> <p>Effect: The effect is noncompliance with HUD guidelines.</p> <p>Corrective Action: Within 30 days from the date of this report, the Owner/Agent must provide signed certifications that:</p> <ul style="list-style-type: none"> • The deficiencies identified in units 7 and 11 have been corrected. • All deficiencies noted in the REAC inspection on 11/2/2016 have been corrected. 	30 Days
C. Maintenance and Standard Operating Procedures	No Findings / Observations in this category.	
E. Leasing and Occupancy	<p>Finding #2 - E.14</p> <p>Condition: The application and recertification package is insufficient to determine applicant eligibility and/or does not include all required contents. The application does not:</p> <ul style="list-style-type: none"> • Ask whether the applicant or any member of the applicant’s household is subject to the state sex offender registration in any state. • Request a listing of states where the applicant and members of the applicant’s household have resided • Request information from applicants who were age 62 or older as of January 31, 2010, and who do not have a SSN, regarding whether they were receiving HUD rental assistance at another location on January 31, 2010 • Give the option to decline to disclose an applicant's gender or marital status • Give the option to decline to disclose an SSN of a household member who does not contend eligible immigration status <p>Additionally, the property’s application does not include or request the following recommended data:</p> <ul style="list-style-type: none"> • Marketing information to understand how the applicant heard about the property 	30 Days

Summary

	<ul style="list-style-type: none"> • Custody arrangement of any children (full, joint, etc.) in the household • Identification of any applicant household member that is a veteran • Whether the family is seeking housing due to a Presidentially Declared Disaster <p>Criteria:</p> <ul style="list-style-type: none"> • HUD Handbook 4350.3 REV-1, CHG-4, 4-14, B, 2: <i>“The owner’s application must request the following information from applicants. a. Whether the applicant or any member of the applicant’s household, is subject to State lifetime sex offender registration in any state. b. Listing of states where the applicant and members of the applicant’s household have resided.”</i> • HUD Handbook 4350.3 REV-1, CHG-4, 4-14, B, 2: <i>“The owner’s application must request the following information from applicants...d. Information from applicants who were age 62 or older as of January 31, 2010, and who do not have a SSN, if they were receiving HUD rental assistance at another location on January 31, 2010. This information is needed in order for the owner to verify whether the applicant qualifies for the exemption from disclosing and providing verification of a SSN.”</i> • TRACS 202D MAT User Guide, Chapter 5, Section 5.4, MAT Field 8, Sex Code: <i>“For each person listed, enter “F” for female; “M” for male or leave blank if either the OA did not ask for the information or the tenant did not voluntarily report ... The final rule on Equal Access to Housing in HUD Programs Regardless of Sexual Orientation or Gender Identity--see 24 CFR 5.105(a)(2)(ii)—prohibits inquiries on sexual orientation or gender identity except in limited circumstances. As a result, for TRACS 202D the Sex Code field on the 50059 may be filled with M, F or a blank to allow for compliance with the rule.”</i> • HUD Handbook 4350.3 REV-1, CHG-4, 3-9, A, 2: <i>“Exceptions to disclosure of SSN: a. Individuals who do not contend eligible immigration status.”</i> • HUD Handbook 4350.3 REV-1, CHG-4, 4-14, B, 1: <i>“Although HUD does not prescribe an application format, a written application form used to initiate verification of eligibility factors should include the following data: a...need for an accessible unit... f. Marketing information to understand how the applicant heard about the property.”</i> • TRACS 202D MAT User Guide, Chapter 5, Section 5.4, MAT Field 10, Special Status Code: <i>“Enter any of the codes listed below which apply to family members identified in Field 7 ... M = Family Member who is a US military veteran. P = Person being housed temporarily pursuant to the guidance in HUD Handbook 4350.1, Chapter38. See MAT Guide, Chapter 4- Presidentially Declared Disasters.”</i> <p>Cause: The condition occurred because the application does not request all required information.</p> <p>Effect: The effect is noncompliance with HUD guidelines.</p> <p>Corrective Action: Within 30 days from the date of this report, the Owner/Agent must provide a copy of a revised application and recertification package including the required elements identified in the Condition section of this finding.</p>	
	<p>Finding #3 - E.14</p> <p>Condition: The Tenant Selection Plan is noncompliant. The Tenant Selection Plan does not mention the following requirements: for rejecting ineligible applicants:</p> <ul style="list-style-type: none"> • Social Security Number requirements <ul style="list-style-type: none"> ○ Applicants who have not disclosed and/or provided verification of SSNs for all non-exempt household members have 90 days from the date they are first offered an available unit to disclose and/or verify the SSNs. During this 90-day period, the applicant may, at its discretion, retain its place on the waiting list. After 90 days, if the applicant is unable to disclose and/or verify the SSNs of all non-exempt household members, the applicant should be determined ineligible and removed from the waiting list. ○ When adding a new household member who is under the age of six to an <i>existing household</i>, the tenant must disclose and provide verification of the SSN of the individual to be added within 90 days of adding the new member. An additional 90 day extension must be granted if delays are due to circumstances beyond the family’s control • Exceptions to the Social Security Number requirements <ul style="list-style-type: none"> ○ Individuals who do not contend eligible immigrations status in Mixed families. ○ Individuals age 62 or older as of January 31, 2010, whose initial determination of 	<p>30 Days</p>

Summary

- eligibility was begun before January 31, 2010. For these individuals, disclosure and verification, documentation must be obtained that verifies the applicant's exemption status.
- Eligibility of students – Section 8 assistance should be provided to students at an institution of higher education when the student:
 - Is living with his or her parents who are receiving Section 8 assistance
 - Is individually eligible to receive Section 8 assistance or has parents who are income eligible to receive Section 8 assistance.
 - Is a person with disabilities, as such term is defined in section 3(b)(3)(E) of the 1937 Act and was receiving assistance under section 8 of the 1937 Act as of November 30, 2005;
 - Is classified as Vulnerable Youth; A student meets HUD's definition of a vulnerable youth when:
 - a. The individual is an orphan, in foster care, or a ward of the court or was an orphan, in foster care, or a ward of the court at any time when the individual was 13 years of age or older;
 - b. The individual is, or was immediately prior to attaining the age of majority, an emancipated minor or in legal guardianship as determined by a court of competent jurisdiction in the individual's State of legal residence;
 - c. The individual has been verified during the school year in which the application is submitted as either an unaccompanied youth who is a homeless child or youth (as such terms are defined in section 725 of the McKinney-Vento Homeless Assistance Act) (42 U.S.C. 11431 et seq.), or as unaccompanied, at risk of homelessness, and self-supporting, by
 - i. A local educational agency homeless liaison, designated pursuant to the McKinney-Vento Homeless Assistance Act;
 - ii. The director of a program funded under the Runaway and Homeless Youth Act or a designee of the director;
 - iii. The director of a program funded under subtitle B of title IV of the McKinney-Vento Homeless Assistance Act (relating to emergency shelter grants) or a designee of the director; or
 - iv. A financial aid administrator; or
 - The individual is a student for whom a financial aid administrator makes a documented determination of independence by reason of other unusual circumstances
 - If an ineligible student applies for or is a member of an existing household receiving Section 8 assistance, the assistance for the household will not be prorated but will be terminated.
 - *NOTE: An owner cannot evict or require an ineligible student to move from a unit as long as the student is in compliance with the terms of the lease.*
 - Procedures for rejecting ineligible applicants
 - The applicant is unable to disclose and provide verification of SSNs for all household members, except for those household members who do not contend eligible immigration status or tenants who were 62 or older on January 31, 2010, whose initial determination of eligibility was begun before January 31, 2010.

Additionally, on page 31 of the Tenant Selection Plan, under Citizenship Verification, it states that "Assistance may not be denied or delayed (or in case of re-examinations, reduced or terminated) on the basis of immigration status if...g. Deferral of termination of assistance is granted in accordance with 24 CFR 5.516 and 5.518 (applicable to re-examination)" Part g. is noncompliant as deferral of assistance is outdated guidance and must be removed from the Tenant Selection Plan.

Criteria:

- **HUD Handbook 4350.3 REV-1, CHG-4, Figure 4-2: Written Tenant Selection Plan – Topics**
- **HUD Handbook 4350.3 REV-1, CHG-4, 3-9, D, 4, b, 1-2:** "Under the age of six without an Assigned SSN: (1)The tenant must disclose and provide verification of the new household member's SSN within calendar days of the child being added to the household. (2)The owner must grant an extension of one additional 90-day period, if the owner, in its discretion, determines that the tenant's failure to comply is due to circumstances that could not have been foreseen and were outside the control of the tenant
- **HUD Handbook 4350.3 REV-1, CHG-4, 3-9, A, 2:** "Exceptions to disclosure of SSN: a. Individuals who do not contend eligible immigration status...b. Individuals age 62 or older as



U.S. Department of Housing and Urban Development
 San Antonio Field Office, Region VI
 Office of Public Housing
 Hipolito Garcia Federal Building
 615 E. Houston Suite 347
 San Antonio, Texas 78205-2001
 Phone (210) 475-6860 Fax (210) 472-6817
www.hud.gov www.espanol.hud.gov

JAN 27 2017

Mrs. Brandy Spencer
 Executive Director
 Bastrop Housing Authority
 PO. Box 707
 Bastrop, TX 78577

Dear Mrs. Spencer:

SUBJECT: SEMAP Certification Final Score, FYE: 09/30/2016
 Bastrop Housing Authority

Thank you for completion of the Section 8 Management Assessment Program (SEMAP) certification for the Bastrop Housing Authority. We appreciate the time and attention that you have given to the SEMAP assessment process. The SEMAP enables HUD to better manage the Section 8 Housing Choice Voucher Tenant-Based Assistance Program by identifying the Authority's capabilities and deficiencies as they relate to the program's administration. As a result, HUD will be able to provide more effective program assistance to the Authority.

The Bastrop Housing Authority's final SEMAP score for the fiscal year ending on September 30, 2016 is 100 percent. The following are the Authority's individual performance indicator scores:

Indicator	1	Selection from Waiting List (24 CFR 982.54(d)(1) and 982.204(a))	15
Indicator	2	Reasonable Rent (24 CFR 982.4, 982.54(d)(15), 982.158(f)(7) and 982.507)	20
Indicator	3	Determination of Adjusted Income (24 CFR part 5, subpart F and 24 CFR 982.516)	20
Indicator	4	Utility Allowance Schedule (24 CFR 982.517)	5
Indicator	5	HQS Quality Control (24 CFR 982.405(b))	5
Indicator	6	HQS Enforcement (24 CFR 982.404)	10
Indicator	7	Expanding Housing Opportunities	5
Indicator	8	Payment Standards (24 CFR 982.503)	5
Indicator	9	Timely Annual Reexaminations (24 CFR 5.617)	10
Indicator	10	Correct Tenant Rent Calculations (24 CFR 982, Subpart K)	5
Indicator	11	Pre-Contract HQS Inspections (24 CFR 982.305)	5
Indicator	12	Annual HQS Inspections (24 CFR 982.405(a))	10
Indicator	13	Lease-Up	20
Indicator	14	Family Self-Sufficiency (24 CFR 984.105 and 984.305)	N/A
Indicator	15	Deconcentration Bonus	N/A

The Authority's overall SEMAP Performance Rating is **High**.

We encourage you to closely monitor your SEMAP performance throughout the year. As a part of these efforts, please ensure that your IMS/PIC data is accurate to ensure that you receive full credit on future ratings.

If you have any questions or require additional information, please contact Simona Berrellesa, Portfolio Management Specialist, at (210) 475-6812.

Sincerely,

A handwritten signature in blue ink, consisting of a large, stylized 'D' followed by a horizontal line that extends to the right.

David Pohler
Director
Office of Public Housing

cc:

Reverend Phil Woods, Chairperson
The Honorable Ken Kesselus, Mayor

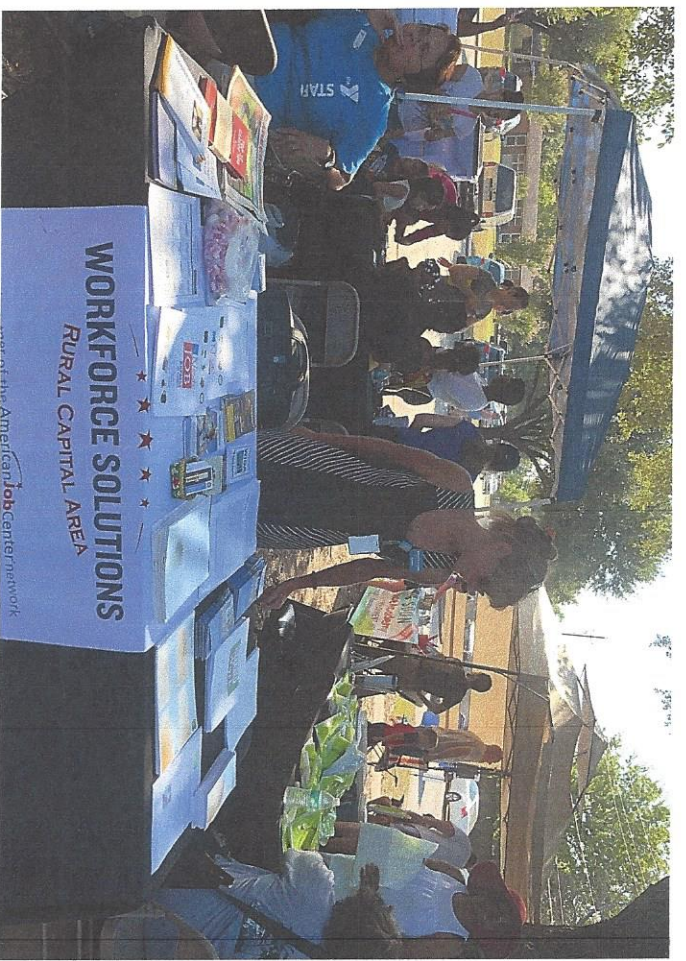



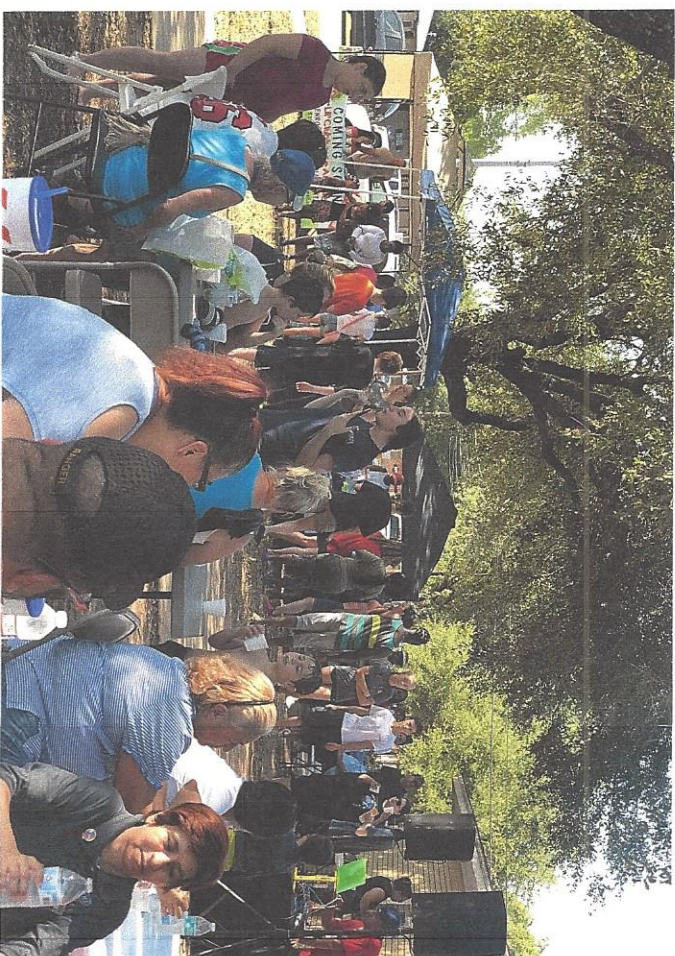



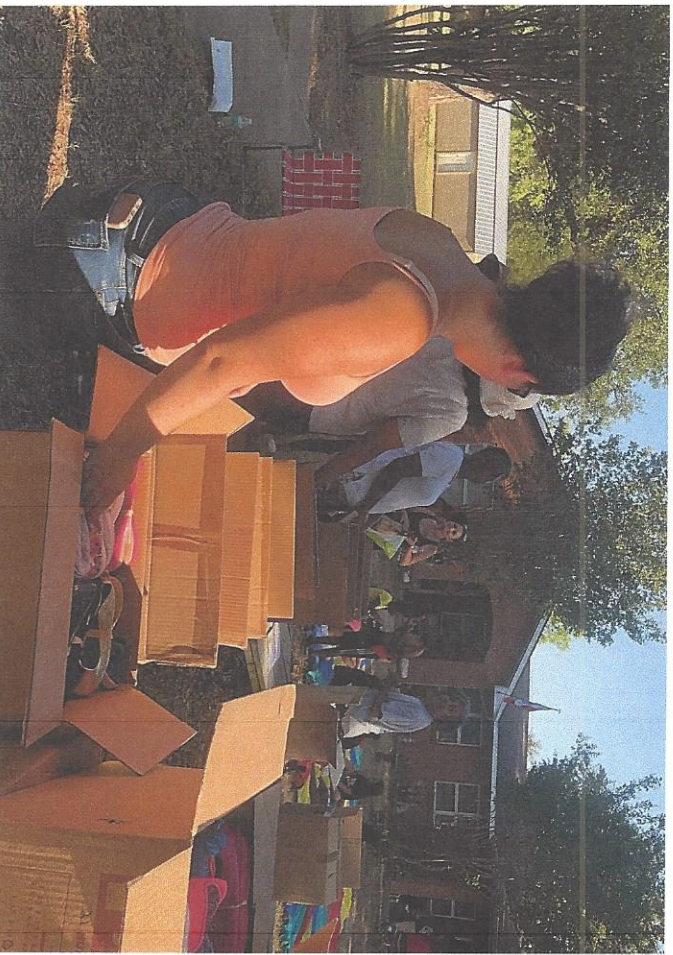
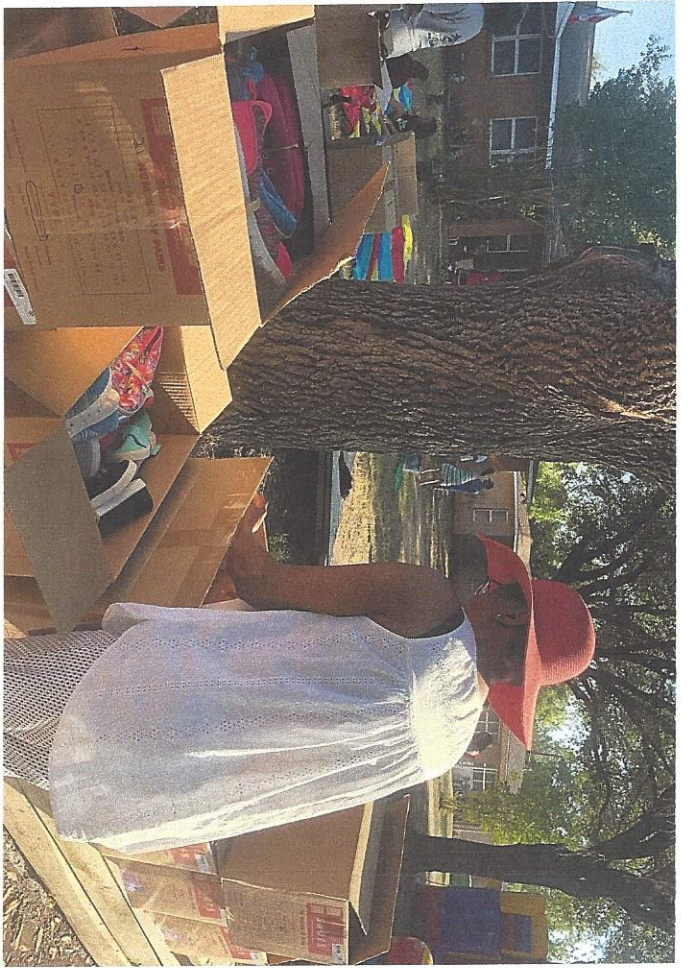



BREEDLOVE & CO., P.C.

CERTIFIED PUBLIC ACCOUNTANTS

17014 Seven Pines Drive
Spring, Texas 77379
(281) 379-1065
(281) 379-6322 (fax)

RICHARD W. BREEDLOVE, CPA
President

JILL A. HENZE, CPA
Vice President

June 7, 2018

Board of Commissioners
Housing Authority of City of Bastrop, Texas
P.O. Box 707
Bastrop, Texas 78602

We have audited the financial statements of the Housing Authority of City of Bastrop, Texas for the year ended September 30, 2017. Professional standards require that we provide you information about our responsibilities under generally accepted auditing standards, *Governmental Auditing Standards* and the Consolidated Audit Guide for Audits of HUD Programs, as well as certain information related to the planned scope and timing of our audit. We have communicated such information in our letter dated July 11, 2017. Professional standards require that we communicate to you the following information related to our audit.

Significant Audit Findings

Qualitative Aspects of Accounting Practices

Management is responsible for the selection and use of appropriate accounting policies. The significant accounting policies used by the Housing Authority of City of Bastrop, Texas are described in Note 1 to the financial statements. No new accounting policies were adopted and the applications of existing policies were not changed during the year ended September 30, 2017. We noted no transactions entered into by the Entity during the year for which there is a lack of authoritative guidance or consensus. All significant transactions have been recognized in the financial statements in the proper period.

Accounting estimates are an integral part of the financial statements prepared by management and are based on management's knowledge and experience about past and current events and assumptions about future events. Certain accounting estimates are particularly sensitive because of their significance to the financial statements and because of the possibility that future events affecting them may differ significantly from those expected. There were no sensitive estimates affecting the financial statements for the year ended September 30, 2017.

Difficulties Encountered in Performing the Audit

We encountered no significant difficulties in dealing with Housing Authority representatives or management during the course of our audit.

Corrected and Uncorrected Misstatements

Professional standards require us to accumulate all misstatements identified during the audit, other than those that are clearly trivial, and communicate them to the appropriate level of management. Management has corrected all such misstatements. The following material misstatements detected as a result of audit procedures will be corrected by the bookkeeper: corrections to opening balances.

HOUSING AUTHORITY OF THE CITY OF BASTROP, TEXAS

REPORT ON FINANCIAL STATEMENTS
(With Supplemental Material)

FOR THE YEAR ENDED SEPTEMBER 30, 2017

BREEDLOVE & CO., P.C.
CERTIFIED PUBLIC ACCOUNTANTS

TABLE OF CONTENTS

Independent Auditors' Report	1-2
Management's Discussion and Analysis	3-10
Financial Statements	
Statement of Net Position	11
Statement of Revenues, Expenses and Changes in Net Position	12
Statement of Cash Flows	13
Notes to Financial Statements	14-18
Report on Compliance and Internal Control over Financial Reporting	19-20

REQUIRED SUPPLEMENTARY INFORMATION

Budgetary Comparison-All Programs	23
-----------------------------------	----

SUPPLEMENTAL SCHEDULES

Financial Data Schedule	26-31
-------------------------	-------

BREEDLOVE & CO., P.C.

CERTIFIED PUBLIC ACCOUNTANTS

17014 Seven Pines Drive
Spring, Texas 77379
(281) 379-1065
(281) 379-6322 (fax)

RICHARD W. BREEDLOVE, CPA
President

JILL A. HENZE, CPA
Vice President

INDEPENDENT AUDITORS' REPORT

June 7, 2018

The Board of Commissioners
Housing Authority of the City of Bastrop, Texas
Bastrop, Texas

We have audited the accompanying financial statements of the business-type activities of the Housing Authority of the City of Bastrop, Texas, as of and for the year ended September 30, 2017, and the related notes to the financial statements, which collectively comprise the Housing Authority of Bastrop, Texas' basic financial statements as listed in the table of contents.

Management's Responsibility for the Financial Statements

Management is responsible for the preparation and fair presentation of these financial statements in accordance with accounting principles generally accepted in the United States of America; this includes the design, implementation, and maintenance of internal control relevant to the preparation and fair presentation of financial statements that are free from material misstatement, whether due to fraud or error.

Auditors' Responsibility

Our responsibility is to express an opinion on these financial statements based on our audit. We conducted our audit in accordance with auditing standards generally accepted in the United States of America and the standards applicable to financial audits contained in *Government Auditing Standards*, issued by the Comptroller General of the United States. Those standards require that we plan and perform the audit to obtain reasonable assurance about whether the financial statements are free from material misstatement.

An audit involves performing procedures to obtain audit evidence about the amounts and disclosures in the financial statements. The procedures selected depend on the auditor's judgment, including the assessment of the risks of material misstatement of the financial statements, whether due to fraud or error. In making those risk assessments, the auditor considers internal control relevant to the entity's preparation and fair presentation of the financial statements in order to design audit procedures that are appropriate in the circumstances, but not for the purpose of expressing an opinion on the effectiveness of the entity's internal control. Accordingly, we express no such opinion. An audit also includes evaluating the appropriateness of accounting policies used and the reasonableness of significant accounting estimates made by management, as well as evaluating the overall presentation of the financial statements.

We believe that the audit evidence we have obtained is sufficient and appropriate to provide a basis for our audit opinion.

HOUSING AUTHORITY OF THE CITY OF BASTROP, TEXAS

MANAGEMENT'S DISCUSSION AND ANALYSIS SEPTEMBER 30, 2017

Introduction

This Management's Discussion and Analysis (MD&A) of the Bastrop Housing Authority (Authority) provides an introduction and overview to the financial statements of the Bastrop Housing Authority for the fiscal year ended September 30, 2017. The Bastrop Housing Authority presents this discussion and analysis of its financial performance during the fiscal year ended September 30, 2017, to assist the reader in focusing on significant financial issues.

The primary focus of the Authority's financial statements is on the statements of its single enterprise fund encompassing all programs administered by the Bastrop Housing Authority. This information contained herein this MD&A should be considered in conjunction with the Authority's basic financial statements and related notes to the financial statements.

The Authority has five individual programs. They include the Low Rent Public Housing Program, the Capital Fund Program, Housing Choice Voucher Program, the Section 8 New Construction Program, and a State/Local program.

- The Low Rent Program consists of 50 dwelling units. Funding is provided based on dwelling rents paid by the tenants and operating fund payments received by the Department of Housing & Urban Development based on a formula.
- The Capital Fund Program is also a formula based program from HUD. The purpose of this program is to provide funding for the modernization and improvement of the Low Rent Public Housing Program. These resources allow the Housing Authority to provide capital improvements for the current dwelling structures and assist in their operations.
- The Housing Choice Voucher Program provides rental assistance to aid low income families in affording decent, safe and sanitary rental housing. The Authority provides rental assistance in the form of a Housing Assistance Payment to a landlord on behalf of the tenant. The Authority currently has 22 units available. Funds are provided by HUD for rental assistance payments. The Authority is provided an administrative fee for the purpose of covering the administrative costs of the program. The fee is preset by HUD on an annual basis.
- The Section 8 New Construction Program is a 30 unit apartment complex that HUD has entered into a contract to provide Housing Assistance Payments to the Authority for these specific units. Tenants typically pay rent which is 30 percent of the adjusted gross income. The remaining portion of the rent is provided by HUD in the form of rental assistance. The apartment complex was financed through the issuance of bonds.
- The State/Local program consists of DHAP funding that is to be used for disaster related purposes.

HOUSING AUTHORITY OF THE CITY OF BASTROP, TEXAS

MANAGEMENT'S DISCUSSION AND ANALYSIS
 SEPTEMBER 30, 2017
 (Continued)

Housing Authority Activities & Highlights

The Housing Authority's overall financial position and operations for the past two years are summarized below based on the information in the current and prior financial statements. The table below lists the asset and liability comparisons for the year ended September 30, 2017, and September 30, 2016.

Summary Statement of Net Position
Years Ended September 30,

Category	FYE 2017	FYE 2016	Change \$	Change %
Current Assets	\$1,190,491	\$1,357,288	(\$166,797)	-12%
Noncurrent Assets	\$521,671	\$484,707	\$36,964	8%
Total Assets	\$1,712,162	\$1,841,995	(\$129,833)	-7%
Current Liabilities	\$38,107	\$38,728	(\$621)	-2%
Long Term Liabilities	-	-	\$0	0%
Total Liabilities	\$38,107	\$38,728	(\$621)	-2%
Deferred Inflows of Resources	\$5,343	-	\$5,343	100%
Unrestricted	\$1,146,041	\$1,317,275	(\$171,234)	-13%
Net Investment in Capital Assets	\$521,671	\$484,707	\$36,964	8%
Restricted	\$1,000	\$1,285	(\$285)	-22%
Total Net Position	\$1,668,712	\$1,803,267	(\$134,555)	-7%

Current Assets

Current Assets decreased from \$1,357,288 to \$1,190,491, a change of \$166,797 or 12% from September 30, 2016 to September 30, 2017. This decrease is primarily due to a roofing project, ADA renovations, and extraordinary maintenance for asbestos abatement.

Noncurrent Assets

Noncurrent Assets consist of capital assets and are discussed in their respective section.

Current Liabilities

Current Liabilities and Deferred Inflows of Resources increased from \$38,728 to \$43,450, a change of \$4,722 from September 30, 2016 to September 30, 2017.

HOUSING AUTHORITY OF THE CITY OF BASTROP, TEXAS

MANAGEMENT'S DISCUSSION AND ANALYSIS
 SEPTEMBER 30, 2017
 (Continued)

Summary Statement of Revenues & Expenses and Changes in Net Position
Years Ended September 30,

<u>Category</u>	<u>FYE 2017</u>	<u>FYE 2016</u>	<u>Change \$</u>	<u>Change %</u>
Tenant Revenue	\$185,429	\$197,756	(\$12,327)	-6%
HUD Operating Grants	\$430,134	\$408,109	\$22,025	5%
Capital Grants	\$0	\$79,185	(\$79,185)	-100%
Interest Income	\$10,592	\$8,452	\$2,140	25%
Other Revenue	\$215,469	\$204,634	\$10,835	5%
Total Revenue	\$841,624	\$898,136	(\$56,512)	-6%
Administration	\$204,624	\$191,862	\$12,762	7%
Tenant Services	\$966	\$2,240	(\$1,274)	-57%
Utilities	\$67,492	\$62,345	\$5,147	8%
Ordinary Maintenance	\$186,155	\$199,490	(\$13,335)	-7%
General Expense	\$38,898	\$36,328	\$2,570	7%
HAP	\$354,933	\$328,365	\$26,568	8%
Extraordinary Maintenance	\$37,879	\$14,272	\$23,607	165%
Depreciation	\$85,232	\$81,212	\$4,020	5%
Total Expenses	\$976,179	\$916,114	\$60,065	7%
Decrease in Net Position	(\$134,555)	(\$17,978)	(\$116,577)	-648%
Net Position, Beginning of Year	\$1,803,267	\$1,821,245	(\$17,978)	-1%
Net Position, End of Year	\$1,668,712	\$1,803,267	(\$134,555)	-7%

Results of Operations

Revenues of the Authority are generated principally from dwelling rents and HUD grants (including Operating and Capital Funds). The Authority's revenue decreased by \$56,512 during the current fiscal year. Accounts with notable changes are listed below:

- Capital grants decreased 100% from September 30, 2016 to September 30, 2017 for a total decrease of \$79,185.
- Government operating grants increased \$22,025 or 5% from September 30, 2016 to September 30, 2017. This was primarily due to the Authority drawing down \$22,404 from the capital fund program for operations.

HOUSING AUTHORITY OF THE CITY OF BASTROP, TEXAS

MANAGEMENT'S DISCUSSION AND ANALYSIS
 SEPTEMBER 30, 2017
 (Continued)

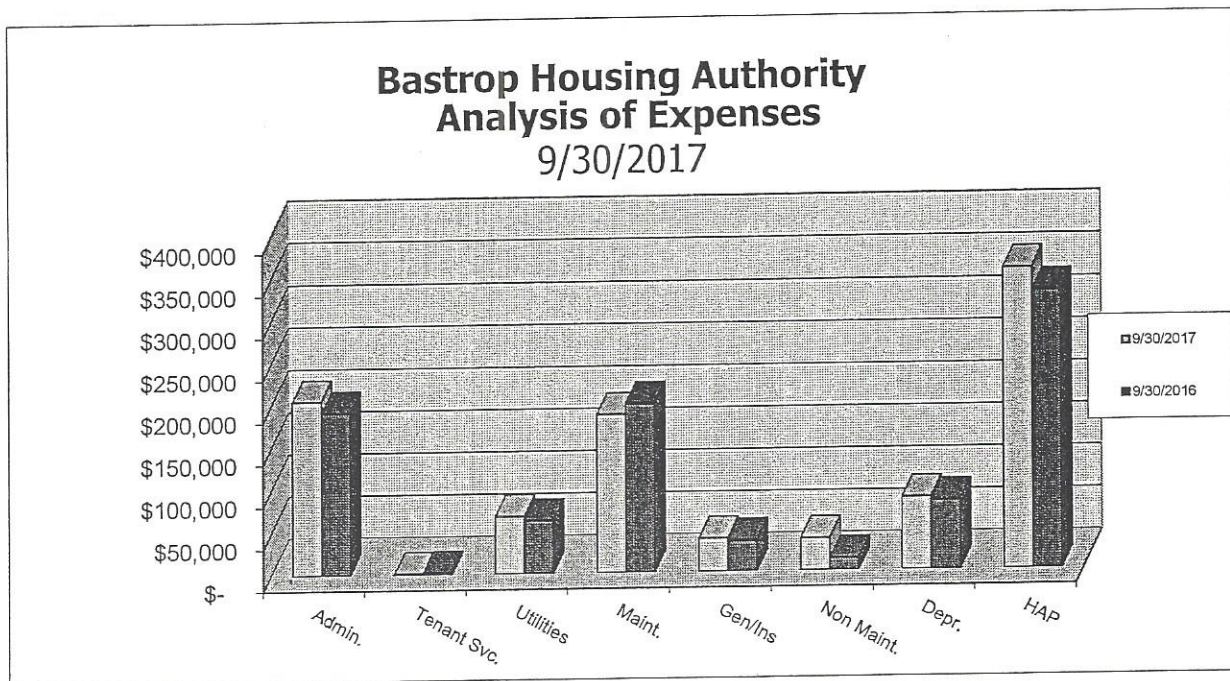

Capital Assets

As of September 30, 2017, the Bastrop Housing Authority's Investment in Capital Assets was \$521,671. This investment includes land, buildings, construction in progress, and equipment net of accumulated depreciation.

**Summary Statement of Capital Assets
 Years Ended September 30**

<u>Category</u>	<u>FYE 2017</u>	<u>FYE 2016</u>	<u>Change \$</u>	<u>Change %</u>
Land	\$48,040	\$48,040	-	0%
Buildings	\$3,732,322	\$3,619,701	\$112,621	3%
Equipment	\$387,392	\$380,793	\$6,599	2%
Accumulated Depreciation	(\$3,651,093)	(\$3,565,861)	(\$85,232)	-2%
Total Net Depreciable Assets	\$516,661	\$482,673	\$33,988	7%
Construction in Progress	\$5,010	\$2,034	\$2,976	146%
Total Net Investment in Capital Assets	\$521,671	\$484,707	\$36,964	8%

Subsequent Events

Due to the 2018 Congressional Appropriations, the Authority's operating subsidy provided by HUD for the Low Rent Housing Program was estimated to be 92% for the calendar year 2017.

The amount of funding for the 2018 calendar year for the Housing Choice Voucher Program has been finalized by HUD. These include the proration of administrative fees being estimated at 77.988% and HAP estimated at 100%.

HOUSING AUTHORITY OF THE CITY OF BASTROP, TEXAS

STATEMENT OF NET POSITION
SEPTEMBER 30, 2017

ASSETS	Housing Enterprise <u>Fund</u>
Current Assets	
Cash and cash equivalents	\$ 1 175 117
Account receivable - HUD	321
Accounts receivable - misc (net of allowance for doubtful accounts of \$313)	434
Accrued interest receivable	237
Prepaid expenses	1 975
Inventories (net of allowance for obsolete inventories of \$1,379)	<u>12 407</u>
Total Current Assets	1 190 491
 Capital Assets net of accumulated depreciation of \$3,651,093	 <u>521 671</u>
 Total Assets	 <u><u>\$ 1 712 162</u></u>
 LIABILITIES AND NET POSITION	
Current Liabilities	
Accounts payable	\$ 6 252
Tenant security deposits	20 219
Accrued payments in lieu of taxes	10 224
Unearned revenue	1 328
Other current liabilities	<u>84</u>
Total Current Liabilities	38 107
 Deferred inflows of resources	 <u>5 343</u>
Net Position	
Net investment in capital assets	521 671
Restricted	1 000
Unrestricted	<u>1 146 041</u>
Total Net Position	<u>1 668 712</u>
 Total Liabilities and Net Position	 <u><u>\$ 1 712 162</u></u>

See accompanying Independent Auditors' Report and Notes to Financial Statements

HOUSING AUTHORITY OF THE CITY OF BASTROP, TEXAS

STATEMENT OF CASH FLOWS
SEPTEMBER 30, 2017

	Housing Enterprise Fund
	<u> </u>
Cash Flows from Operating Activities:	
Operating Grants	\$ 435 276
Receipts from Customers	396 763
Payments to Suppliers	(636 850)
Payments to Employees	<u>(254 047)</u>
Net Cash Used for Operating Activities	<u>(58 858)</u>
Cash Flow from Capital and Related Financing Activities:	
Capital asset additions	<u>(122 196)</u>
Net cash used for capital and related financing activities	<u>(122 196)</u>
Cash Flow From Investing Activities	
Interest income - unrestricted	10 592
Decrease in accrued interest	<u>112</u>
Net Cash Provided by Investing Activities	<u>10 704</u>
Net Decrease In Cash and Cash Equivalents	(170 350)
Cash and Cash Equivalents At Beginning of Year	<u>1 345 467</u>
Cash and Cash Equivalents At End of Year	<u>\$ 1 175 117</u>
Reconciliation of Net Operating Loss to Net Cash from Operations:	
Net Loss from Operations	\$ (145 147)
Noncash Changes to Net Loss:	
Depreciation	85 232
Changes in Assets and Liabilities:	
(Increase) Decrease in Assets:	
Accounts receivable - tenants	20
Accounts receivable - HUD	(201)
Accounts receivable - MISC	191
Notes receivable - tenants	581
Prepaid expenses	(1 798)
Inventories	(2 458)
Increase (Decrease) in Liabilities:	
Accounts payable	4 318
Tenant security deposits	(5 953)
Accrued payment in lieu of taxes	(57)
Unearned revenues	1 025
Other accrued liabilities	46
Deferred inflow of resources	<u>5 343</u>
Net Cash Used for Operating Activities	<u>\$ (58 858)</u>

See accompanying Independent Auditors' Report and Notes to Financial Statements

HOUSING AUTHORITY OF THE CITY OF BASTROP, TEXAS

NOTES TO FINANCIAL STATEMENTS
SEPTEMBER 30, 2017
(Continued)

NOTE (1) ORGANIZATION AND SUMMARY OF SIGNIFICANT ACCOUNTING POLICIES (Continued)

B. Measurement Focus and Basis of Accounting (Continued) - The accrual basis of accounting recognizes revenues when earned and expenses when incurred. Operating revenues and expenses generally result from providing services and delivering goods in connection with a Proprietary Fund's ongoing operations. Revenues and expenses not meeting this definition are reported as non-operating revenues and expenses. The principal operating revenues of the PHA are tenant revenues and the moneys provided by HUD. The operating expenses of the PHA consist primarily of administrative costs, utilities, maintenance, and general expenses.

The PHA applies all applicable GASB pronouncements. The PHA has elected not to apply FASB Statements of Interpretations issued after November 30, 1989.

C. Cash and Cash Equivalents - The proprietary fund types consider all highly liquid investments with a maturity of three months or less when purchased to be cash equivalents. Certificates of deposit are considered cash equivalents. Other liquid investments with a maturity of over three months when purchased are considered to be investments. The PHA invests in instruments whose values are not subject to market fluctuations and are carried at cost plus accrued interest.

D. Tenant Receivables - Receivables for rentals or service charges are reported net of allowance for doubtful accounts.

E. Inventory - Inventory consists of maintenance supplies held for consumption stated at cost on a first in, first out basis.

F. Compensated Absences - Employees are granted vacation and sick leave benefits depending on tenure with the PHA. Annual leave must be taken by September 30 of each year and may not be accumulated.

G. Capital Assets and Depreciation - Land, structures and equipment are stated at historical cost. Individual assets that exceed the Board approved threshold limit of \$2,000 with an estimated useful life in excess of one year are capitalized and depreciated while smaller assets are expensed as consumable supplies. Depreciation is computed using the straight-line method. Estimated useful lives, in years, for depreciable assets are as follows:

Site improvements	10 years
Buildings	30 years
Building improvements	10 years
Non-dwelling structures	30 years
Equipment	5 to 10 years

H. Budgetary Data - The PHA is required by its HUD Annual Contributions Contract to adopt an annual budget for its proprietary fund programs which receive federal funding.

The PHA is under a limited budget review from HUD with the control category of total operating expenditures. If there are no overruns of the total operating expenditures, then HUD does not require budget revisions other than when there are substantial additions to non-routine expenditures. Budgeted amounts are as originally adopted or as amended by the Board.

The budget is prepared on a statutory (HUD) basis and does not contain a provision for uncollectible tenant receivables. The budget does reflect furniture and equipment additions from operations.

HOUSING AUTHORITY OF THE CITY OF BASTROP, TEXAS

NOTES TO FINANCIAL STATEMENTS
 SEPTEMBER 30, 2017
 (Continued)

NOTE (3) CAPITAL ASSETS

Land, structures and equipment reported in the PHA are as follows:

	Balances at 9/30/2016	Additions (Dispositions)/ Reclassifications	Depreciation	Balances at 9/30/2017
Land	\$ 48 040	\$ -	\$ -	\$ 48 040
Buildings	3 619 701	112 621	-	3 732 322
Furniture and Equipment	380 793	6 599	-	387 392
	4 000 494	119 220	-	4 119 714
Accumulated Depreciation	(3 565 861)	-	(85 232)	(3 651 093)
Net book Value	434 633	119 220	(85 232)	468 621
Construction in Progress	2 034	2 976	-	5 010
Totals	<u>\$ 484 707</u>	<u>\$ 122 196</u>	<u>\$ (85 232)</u>	<u>\$ 521 671</u>

All land, buildings and improvements are encumbered by a declaration of trust in favor of the United States of America as security for obligations guaranteed by the government and to protect other interests of the government.

NOTE (4) FEDERAL GRANTS

In the normal course of operations, the PHA receives grant funds from various governmental agencies. These grant programs are subject to audit by agents of the granting agency, the purpose of which is to ensure compliance with the provisions of the granting agency. Any liability for reimbursement which may arise as the result of these audits is not believed to be material.

NOTE (5) TENANT SECURITY DEPOSITS

At September 30, 2017 the PHA held \$20,219 in tenant security deposits, which is fully repayable upon termination of a tenant lease.

NOTE (6) RESTRICTED NET POSITION

The PHA has recorded \$1,000 in restricted net position for the year ending September 30, 2017. These funds are restricted for future payments of eligible emergencies and disaster vouchers.

BREEDLOVE & CO., P.C.

CERTIFIED PUBLIC ACCOUNTANTS

17014 Seven Pines Drive
Spring, Texas 77379
(281) 379-1065
(281) 379-6322 (fax)

RICHARD W. BREEDLOVE, CPA
President

JILL A. HENZE, CPA
Vice President

INDEPENDENT AUDITORS' REPORT ON INTERNAL CONTROL OVER FINANCIAL
REPORTING AND ON COMPLIANCE AND OTHER MATTERS BASED ON AN AUDIT OF
FINANCIAL STATEMENTS PERFORMED IN ACCORDANCE WITH GOVERNMENT AUDITING
STANDARDS

June 7, 2018

Board of Commissioners
Housing Authority of the City of Bastrop, Texas
Bastrop, Texas

We have audited, in accordance with the auditing standards generally accepted in the United States of America and the standards applicable to financial audits contained in *Government Auditing Standards* issued by the Comptroller General of the United States, the financial statements of the business-type activities of the Housing Authority of the City of Bastrop, Texas as of and for the year ended September 30, 2017, and the related notes to the financial statements, which collectively comprise of the Housing Authority of the City of Bastrop, Texas' basic financial statements and have issued our report thereon dated June 7, 2018.

Internal control over Financial Reporting

In planning and performing our audit of the financial statements, we considered the Housing Authority of the City of Bastrop, Texas' internal control over financial reporting (internal control) to determine the audit procedures that are appropriate in the circumstances for the purpose of expressing our opinions on the financial statements, but not for the purpose of expressing an opinion on the effectiveness of the Housing Authority of the City of Bastrop, Texas' internal control over financial reporting. Accordingly, we do not express an opinion on the effectiveness of the Housing Authority of the City of Bastrop, Texas' internal control.

A *deficiency in internal control* exists when the design or operation of a control does not allow management or employees, in the normal course of performing their assigned functions, to prevent, or detect and correct, misstatements on a timely basis. A *material weakness* is a deficiency, or a combination of deficiencies, in internal control such that there is a reasonable possibility that a material misstatement of the entity's financial statements will not be prevented, or detected and corrected on a timely basis. A *significant deficiency* is a deficiency, or a combination of deficiencies, in internal control that is less severe than a material weakness, yet important enough to merit attention by those charged with governance.

REQUIRED SUPPLEMENTARY INFORMATION

HOUSING AUTHORITY OF THE CITY OF BASTROP, TEXAS

REQUIRED SUPPLEMENTARY INFORMATION-BUDGETARY COMPARISON -
ALL PROGRAMS
FOR THE YEAR ENDED SEPTEMBER 30, 2017

	<u>Original</u>	<u>Final</u>	<u>Actual</u>	Variance
	<u>Budget</u>	<u>Budget</u>		Positive (Negative)
Operating Revenues				
Dwelling Rental	\$ 197 820	\$ 185 540	\$ 181 434	\$ (4 106)
Other Revenues	5 270	5 675	219 465	213 790
Operating Subsidy and Grants	248 260	234 420	414 335	179 915
Administrative Fees Earned	<u>29 000</u>	<u>28 900</u>	<u>15 799</u>	<u>(13 101)</u>
Total Operating Revenues	<u>480 350</u>	<u>454 535</u>	<u>831 033</u>	<u>376 498</u>
 Operating Expenses				
Administrative	204 860	217 505	204 624	12 881
Tenant Services	2 500	1 350	966	384
Utilities	69 750	69 900	67 492	2 408
Maintenance	183 510	183 960	186 155	(2 195)
Extraordinary Maintenance	5 000	36 550	37 879	(1 329)
General	27 610	28 310	38 898	(10 588)
Housing Assistance Payments	-	-	157 825	(157 825)
Housing Assistance Payments-Port In	-	-	197 109	(197 109)
Depreciation	<u>-</u>	<u>-</u>	<u>85 232</u>	<u>(85 232)</u>
Total Operating Expenses	<u>493 230</u>	<u>537 575</u>	<u>976 180</u>	<u>(438 605)</u>
 Non-Operating Revenues				
Interest Income	<u>8 050</u>	<u>9 300</u>	<u>10 592</u>	<u>1 292</u>
Total Non-Operating Revenues	<u>8 050</u>	<u>9 300</u>	<u>10 592</u>	<u>1 292</u>
Residual Receipts (Deficit)	<u>\$ (4 830)</u>	<u>\$ (73 740)</u>	<u>\$ (134 555)</u>	<u>\$ (60 815)</u>

See the accompanying Independent Auditors' Report

SUPPLEMENTAL SCHEDULES

HOUSING AUTHORITY OF THE CITY OF BASTROP, TEXAS

FINANCIAL DATA SCHEDULE

BALANCE SHEET

SEPTEMBER 30, 2017

(Continued)

Account Description		N/C/S/R Section 8 Programs 14.182	Low Rent 14.850a	Housing Choice Vouchers 14.871	CFP 14.872	97.109 Disaster Housing Assistance Grant	TOTAL
LIABILITIES AND EQUITY:							
LIABILITIES:							
Current Liabilities							
311	Bank overdraft	-	-	-	-	-	-
312	Accounts payable ≤ 90 days	718	2,331	184	-	-	3,233
313	Accounts payable > 90 days past due	-	-	1,682	-	-	1,682
321	Accrued wage/payroll taxes payable	-	1,337	-	-	-	1,337
322	Accrued compensated absences - current portion	-	-	-	-	-	-
324	Accrued contingency liability	-	-	-	-	-	-
325	Accrued interest payable	-	-	-	-	-	-
331	Accounts payable - HUD PHA programs	-	-	-	-	-	-
332	Accounts Payable - PHA Projects	-	-	-	-	-	-
333	Accounts payable - other government	-	10,224	-	-	-	10,224
341	Tenant security deposits	6,536	13,683	-	-	-	20,219
342	Unearned revenues	386	942	-	-	-	1,328
343	Current portion of Long-Term debt - capital projects/mortgage revenue bonds	-	-	-	-	-	-
344	Current portion of Long-Term debt - operating borrowings	-	-	-	-	-	-
345	Other current liabilities	-	-	-	-	-	-
346	Accrued liabilities - other	-	84	-	-	-	84
347	Inter-program - due to	19,229	-	5,084	-	-	24,313
348	Loan Liability - current	-	-	-	-	-	-
310	TOTAL CURRENT LIABILITIES	26,869	28,601	6,950	-	-	62,420
Non Current Liabilities							
351	Long-term debt, net of current- capital projects/ mortgage revenue bonds	-	-	-	-	-	-
352	Long-term debt, net of current- operating borrowings	-	-	-	-	-	-
353	Noncurrent liabilities- other	-	-	-	-	-	-
354	Accrued Compensated Absences - non current	-	-	-	-	-	-
355	Loan Liability - non current	-	-	-	-	-	-
350	TOTAL NONCURRENT LIABILITIES	-	-	-	-	-	-
300	TOTAL LIABILITIES	26,869	28,601	6,950	-	-	62,420
400	Deferred Inflow of Resources	-	5,343	-	-	-	5,343
EQUITY:							
508.1	Net Investment in Capital Assets	230,069	247,423	-	44,179	-	521,671
509.2	Fund balance reserved	-	-	-	-	-	-
511.2	Unreserved, designated fund balance	-	-	-	-	-	-
511.1	Restricted net position	-	-	-	-	1,000	1,000
512.1	Unrestricted net position	886,681	226,420	32,940	-	-	1,146,041
512.2	Undesignated fund balance/retained earnings	-	-	-	-	-	-
513	TOTAL EQUITY/NET POSITION	1,116,750	473,843	32,940	44,179	1,000	1,668,712

HOUSING AUTHORITY OF THE CITY OF BASTROP, TEXAS

**FINANCIAL DATA SCHEDULE
STATEMENT OF REVENUES, EXPENSES AND CHANGES IN NET POSITION
FOR THE YEAR ENDED SEPTEMBER 30, 2017
(Continued)**

Account Description		N/C/SR Section 8 Programs H.182	Low Rent H.850a	Housing Choice Vouchers H.871	CFP H.872	97.109 Disaster Housing Assistance Grant	TOTAL
	Ordinary maintenance & operation						
94100	Ordinary maintenance and operations - labor	36,438	39,858	-	-	-	76,296
94200	Ordinary maintenance and operations - materials & other	15,484	19,476	-	-	-	34,960
94300-010	Garbage and trash removal contracts	7,622	8,773	-	-	-	16,395
94300-020	Heating and cooling contracts	575	1,914	-	-	-	2,489
94300-030	Snow removal contracts	-	-	-	-	-	-
94300-040	Elevator maintenance contracts	-	-	-	-	-	-
94300-050	Landscape and grounds contracts	532	10,700	-	-	-	11,232
94300-060	Unit turnaround contracts	-	-	-	-	-	-
94300-070	Electrical contracts	103	-	-	-	-	103
94300-080	Plumbing contracts	1,211	5,785	-	-	-	6,996
94300-090	Extermination contracts	858	1,462	-	-	-	2,320
94300-100	Janitorial contracts	-	525	-	-	-	525
94300-110	Routine maintenance contracts	-	-	-	-	-	-
94300-120	Miscellaneous contracts	1,163	3,330	-	-	-	4,493
94300	Total ordinary maintenance and operations - contract costs	12,064	32,489	-	-	-	44,553
94500	Employee benefit contributions- ordinary maintenance	14,350	15,996	-	-	-	30,346
94000	Subtotal	78,336	107,819	-	-	-	186,155
	Protective services						
95100	Protective services - labor	-	-	-	-	-	-
95200	Protective services- other contract costs	-	-	-	-	-	-
95300	Protective services - other	-	-	-	-	-	-
95500	Employee benefit contributions- protective services	-	-	-	-	-	-
95000	Subtotal	-	-	-	-	-	-
	General expenses						
96110	Property insurance	4,044	5,855	-	-	-	9,899
96120	Liability insurance	112	188	-	-	-	300
96130	Workman's compensation	2,035	2,125	362	-	-	4,522
96140	All other insurance	-	616	20	-	-	636
96100	Total Insurance premiums	6,191	8,784	382	-	-	15,357
96200	Other General Expenses	-	1,141	-	-	-	1,141
96210	Compensated absences	4,802	5,147	1,210	-	-	11,159
96300	Payments in lieu of taxes	-	10,251	-	-	-	10,251
96400	Bad debt - tenant rents	547	202	241	-	-	990
96500	Bad debt- mortgages	-	-	-	-	-	-
96600	Bad debt - other	-	-	-	-	-	-
96800	Severance expense	-	-	-	-	-	-
	Subtotal	11,540	25,525	1,833	-	-	38,898
96710	Interest of mortgage (or bonds) payable	-	-	-	-	-	-
96720	Interest on notes payable (short or long term)	-	-	-	-	-	-
96730	Amortization of bond issue costs	-	-	-	-	-	-
96700	Total interest expense and amortization cost	-	-	-	-	-	-
96900	TOTAL OPERATING EXPENSES	206,296	263,310	28,529	-	-	498,135
97000	EXCESS OPERATING REVENUE OVER OPERATING EXPENSES	(20,135)	(15,367)	356,588	22,404	-	343,490

See the accompanying Independent Auditors' Report

HOUSING AUTHORITY OF THE CITY OF BASTROP, TEXAS

**FINANCIAL DATA SCHEDULE
STATEMENT OF REVENUES, EXPENSES AND CHANGES IN NET POSITION
FOR THE YEAR ENDED SEPTEMBER 30, 2017
(Continued)**

Account Description		N/C SR Section 8 Programs H. 82	Low Rent H. 850a	Housing Choice Vouchers H. 871	CFP H. 872	97.109 Disaster Housing Assistance Grant	TOTAL
MEMO account information							
11020	Required annual debt principal payments	-	-	-	-	-	-
11030	Beginning equity	1,181,415	510,381	31,286	79,185	1,000	1,803,267
11040	Prior period adjustments, equity transfers and correction of errors	-	31,850	-	(31,850)	-	-
11050	Changes in compensated absence liability balance (in the GLTDAG)	-	-	-	-	-	-
11060	Changes in contingent liability balance (in the GLTDAG)	-	-	-	-	-	-
11070	Changes in unrecognized pension transition liability (in the GLTDAG)	-	-	-	-	-	-
11080	Changes in special term/severance benefits liability (in the GLTDAG)	-	-	-	-	-	-
11090	Changes in allowance for doubtful accounts - dwelling rents	-	-	-	-	-	-
11100	Changes in allowance for doubtful accounts - other	-	-	-	-	-	-
11170	Administrative fee equity	-	-	32,940	-	-	32,940
11180	Housing assistance payments equity	-	-	-	-	-	-
11190	Unit months available	360	600	264	-	-	1,224
11210	Number of unit months leased	309	582	262	-	-	1,153
11270	Excess cash	-	201,549	-	-	-	201,549
11610	Land purchases	-	-	-	-	-	-
11620	Building purchases	112,621	-	-	-	-	112,621
11630	Furniture and equipment - dwelling purchases	-	-	-	-	-	-
11640	Furniture and equipment - administrative purchases	6,599	-	-	-	-	6,599
11650	Leasehold improvement purchases	-	-	-	-	-	-
11660	Infrastructure purchases	-	-	-	-	-	-
13510	CFPP debt service payments	-	-	-	-	-	-
13901	Replacement housing factor funds	-	-	-	-	-	-

See the accompanying Independent Auditors' Report



STAFF REPORT

MEETING DATE: November 13, 2018

AGENDA ITEM: 6B

TITLE:

Provide Update on FY 2018 Organizational Work Plan Accomplishments & Discuss FY 2019 Organizational Work Plan.

STAFF REPRESENTATIVE:

Lynda K. Humble, City Manager

HISTORY/BACKGROUND:

The City Manager is required to give a semi-annual update of the Organizational Work Plan annually in May and a year-end update of the Organizational Work Plan annually in November as a part of her annual performance review. This update will serve as the year-end update.

ATTACHMENTS:

- FY 2018 Work Plan Accomplishments
- FY 2019 Work Plan
- Comprehensive Plan Update

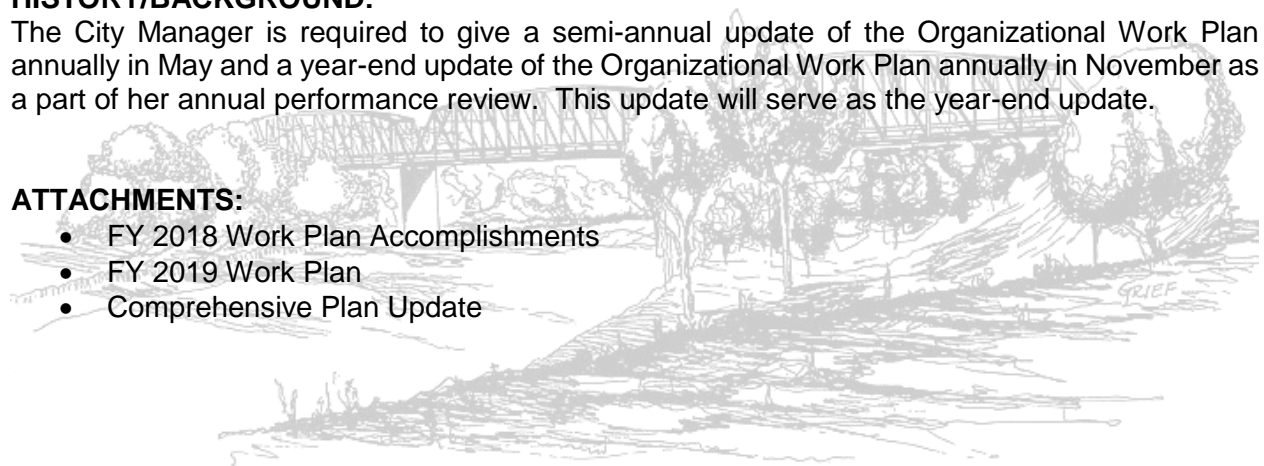

Policy & Operational FY 2018 Strategic Review

The City Council adopted nine (9) focus areas to provide structure around how organizational resources should be allocated to achieve their Vision. A Five (5) Year Operational Workplan was created in September 2017 and built around these nine (9) areas. This FY2018 – FY 2022 Work Plan contains 186 items, of which 113 items or 61% were placed in FY 2018.

In FY 2018, 65 items were completed, 33 items are in progress, and 20 received no action. There were five (5) items moved up from future years. So, of the 61% or 113 items included in the FY 2018 work plan, 87% of these items were completed or in-progress.

Outlined below is a summary highlighting many of the **OUTSTANDING** FY 2018 Work Plan accomplishments, which underscores the strong partnership between policy and operations.



Authentic Bastrop

Maintain and enhance our historic community feel by leveraging the combination of community, cultural, and recreational assets that make Bastrop a special place to live and work.

FY 2018 Achievements:

- Hired Go Collaborative to conduct a Cultural Arts Masterplan. Expected completion – January 2019.
- Provided coordination/logistical support for 50+ special events.
- Addressed public concern about roaming chickens/roosters by hiring a trapper, removing 93 chickens/roosters by year-end, and repealing the chicken sanctuary.
- Completed design for a skate park.
- Completed Delgado Park – Phase 1.



Communication

Support and enhance open two-way communication between the City and its residents and businesses

FY 2018 Achievements:

- Established City's communication vision and goals and increased social media engagement by 93%.
- Implemented customer portal to access individual utility billing information.
- Prepared FY 2019 budget for Distinguished Budget Presentation award.
- Improved visual experience to viewers watching Council meetings.
- Held joint workshops with City Council and active boards and commissions.



Community Safety

Keep citizens, businesses, and visitors safe.

FY 2018 Achievements:

- Conducted over 2,350 hours of emergency management training organization-wide.
- Created and implemented a Crisis Communication Plan.
- Completed FEMA Shelter, located at 1206 Linden.
- Installed new street signage with hundred block identification.
- Implemented rights-of-Way mowing contract.
- Completed Well J at XS Ranch.
- Awarded professional service agreement for design and construction management of a new wastewater treatment plant.
- Awarded professional service agreement for design and construction management of a new water treatment plant.

FY 2018 Achievements



Economic Vitality

Create sustainability by leveraging infrastructure renewals and investment, enhancing public/private partnerships, and fostering an inclusive and diverse environment that encourages entrepreneurial ventures and tourism.

FY 2018 Achievements:

- Held quarterly meetings with BP&L Community Support groups.
- Prepared Certification of Obligation Sale of \$4.7 million with no tax increase.
- Developed \$63 million Capital Improvement Program to address essential water, wastewater, streets, and drainage needs and commitments for trails by prior Councils.
- Increased FY2018 Convention Center rentals by 50% over FY2017.
- Approved contract with Visit Bastrop to promote tourism in the City of Bastrop.
- Partnered through Main Street with the Chamber and BEDC to launch an annual training calendar and resource opportunities – 300 participants completed at least 1 offering.



Fiscal Responsibility

Prepare and manage budget; fiduciary responsibility.

FY 2018 Achievements:

- Conducted ground-truthing sonar on west section of Fairview Cemetery.
- Saved \$100,000 in Year 1 in health claims through Compass Medical Services, with a 13:1 return-on-investment.
- Received less than 25 Workers' Compensation claims with less than five (5) loss-time claims.
- Updated City's Catastrophic Sick Leave Policy.
- Had 49 submittals in Engineering Request for Qualification process, which resulted in 12 engineering firms being added to the List of Qualified Engineers in eight (8) categories.
- Created Hospitality & Downtown Department to coordinate community resources, enhance citizens' understanding of value, and leverage the visitors' experience.
- Completed Pavement Condition Impact Study and developed and funded 1st two (2) years of street maintenance program.



Manage Growth

Plan for and manage growth, development, and redevelopment to maintain Bastrop's authentic feel and character.

FY 2018 Achievements:

- Drafted new Subdivision Ordinance.
- Hired Simplicity Design to begin process of "coding DNA" of downtown Bastrop.



Multi-Modal Mobility

Improved mobility for all modes of transit to integrate the community through connectivity.

FY 2018 Achievements:

- Approved Interlocal Agreement with CARTS.
- Hired MWM Design to design State Park Trail.
- Awarded contract for concrete contractor to complete gaps in sidewalks for traffic safety in Downtown.



Organizational Excellence

Organize governance; progressive operational policies and procedures; employee and citizen volunteer recognition.

FY 2018 Achievements:

- Implemented Neogov Software to improve employee onboarding and online job applications.
- Implemented Tyler Technology Police Records Management System, Police Computer Aided Dispatch, and Municipal Court software
- Held 1st Annual Boards & Commission & Volunteer Banquet.
- Held 1st Annual Boards, Commissions, and Volunteer Fair.
- Implemented a Citizen Input Survey on capital improvements, programs, and services.
- Participated in NIBBLES Backpack program building food bags feeding 100 food insecure BISD students each weekend during school year.
- Established 10-year maintenance program for water and wastewater infrastructure replacement.
- Completed Year 1 of testing 56,000 feet of sewer lines for Inflow & Infiltration, identifying and repairing 166 deficiencies – (Item moved up from FY 2019.)
- Revised City's Board & Commission Application.
- Hired Assistant Director of Public Works.
- Developed Emergency Management Plan Readiness Levels.



Unique Environment

Continue beautification of natural areas, parks, river, and landscape.

FY 2018 Achievements:

- Coordinated an Adopt-a-Street program with Keep Bastrop County Beautiful, which has adopted out 12 streets.
- Improved Christmas Lighting in Downtown and Fisherman's Park.
- Awarded professional service agreement for design and construction management for structural rehabilitation of the Old Iron Bridge. (Item moved up from FY 2019.)

Strategic Focus - FY 2019

The FY 2019 Organizational Work Plan contains 84 items considered “in-progress” in FY 2018, identified organizational “game changers” that correct manual time-consuming processes, all significant Innovation Fund items budgeted in FY 2019, and all ancillary items associated with the management of the Capital Improvement Program. **There are multiple items included in this workplan that will take several years to complete and will be carried-over in future years.**



Authentic Bastrop

Maintain and enhance our historic community feel by leveraging the combination of community, cultural and recreational assets that make Bastrop a special place to live and work.

AB #1	Complete Main Street Rehabilitation Project- <i>CIP Street Project</i> . (Comp Plan 6.3)
AB #2	Complete Old Iron Bridge Rehabilitation Project – <i>CIP Street Project</i> . (Comp Plan 7.1.3)
AB #3	Obtain Certified Local Government designation. (Comp Plan 4.5.1)
AB #4	Continue to facilitate downtown incentive grant program. (Comp Plan 8.1.6)
AB #5	Continue relocation program of chickens/roosters in downtown Bastrop.
AB #6	Develop a plan for private initiative to program and operate the City’s rodeo arena. (Comp 7.2.2)
AB #7	Build Phase I of Skate Park in Fisherman’s Park. (Comp Plan 7.2)
AB #8	Implement Cultural Arts Masterplan. (Comp Plan – 8.4.1)
AB #9	Complete North Main Community Rehabilitation Project including water and wastewater line replacement, street rehabilitation, and drainage improvements – <i>CIP Project</i> . (Comp Plan 2.5, 2.2, 2.6, 6.3)

Communication

Support and enhance open 2-way communication between the City and its residents and businesses.

C #1	Create and implement robust Capital Improvement Program Communication Program.
C #2	Create and maintain an annual calendar of City & Community Events for Council use.
C #3	Develop and produce a monthly electronic newsletter that tells the City’s story, whether it is about our value and/or to educate and/or engage our citizens while being open and transparent, distributed via our website and social media.
C #4	Develop process for monitoring and answering questions during Council Meetings on social media.
C #5	Develop a robust social media policy and metrics.
C #6	Install the VoteLynx System in Council Chambers.
C #7	Continue to improve communications with the Development Community.
C #8	Develop a “Librarian on the Loose” outreach program to take library services to nursing homes, correctional institutions, and schools.
C #9	Review and update BTXN (Cable Channel) ordinance and fee schedule.
C #10	Transition from Code Red to Everbridge, in conjunction with Central Texas Area Council of Governments, to better inform and education the community during emergency situations.
C #11	Evaluate options to utilize BTXN as a timely way to tell the City’s story, whether it is about our value and/or to educate and/or engage our citizens while being open and transparent, distributed via our cable channel, website, brick & mortar locations, and social media.

Organizational Work Plan - FY 2019

Community Safety

Keep citizens, businesses, and visitors safe.

CS #1	Design and Build Wastewater Treatment Plant #3 – <i>CIP Wastewater Project</i> . (Comp Plan 2.4)
CS #2	Complete Well J, Design and Construct Water Plant & Water Line to Willow Plant – <i>CIP Water Project</i> . (Comp Plan 2.2)
CS #3	Complete Water Tower at SH20 & SH71 – <i>CIP Water Project</i> . (Comp Plan 2.2)
CS #4	Conduct a feasibility study to determine costs and steps associated with achieving a full-time paid fire department. (Comp Plan 3.1.4)
CS #5	Update drainage regulations (include 2018 Half Drainage Study and Atlas 14 Map Data) without negatively impacting the existing population or environment. (Comp Plan 2.6)
CS #6	Complete street signage inventory and replacement schedule. (Comp Plan 6.4)
CS #7	Create and adopt a formal addressing policy utilizing the Capital Area Council of Governments methodology.
CS #8	Complete design of Public Works Detention Pond and Pine Street and Jasper/Newton Drainage Improvements. – <i>CIP Drainage Projects</i> (Comp Plan 2.6)

Economic Vitality

Create sustainability by infrastructure renewal and investment; enhancing public/private partnerships; efficient planning and development processes; and fostering an inclusive and diverse environment that encourages entrepreneurial ventures and tourism.

EV #1	Develop Fiscal Impact Analysis to determine development related financial sustainability. (Comp Plan 2.1)
EV #2	Complete research TABC license for potential alcohol permit at the Bastrop Convention Center. (Comp Plan - 8.3.2)
EV #3	Continue increasing rental revenue of Convention Center by supporting local businesses, small conventions, and conferences. (Comp. Plan – 8.3.2)
EV #4	Update Film Permit Process.
EV #5	Leverage the film commission to use film as an economic development strategy.
EV #6	Continue relations and connectivity with the Hyatt Lost Pines Resort. (Comp Plan – 8.5.1)
EV #7	Strengthen our downtown retail presence. (Comp Plan 8.1.5)
EV #8	Continue ongoing development of the Bastrop visitor experience to include the community’s culinary and cultural assets. (Comp Plan 8.5)
EV #9	Create a Code Enforcement Strategic Plan and a communication program to educate public. (Comp Plan 3.1)
EV #10	Conduct Food Truck Pilot Project, address concerns, and finalize Ordinance. (Comp 8.6.1)

Fiscal Responsibility

Prepare and manage budget; fiduciary responsibility.

FR #1	Implement Year 1 of Street Maintenance Program. (Comp Plan 6.3)
FR #2	Revise Special Events Ordinance and Procedures to meet the City’s Financial Policy requirement of fees covering cost of service. (Comp Plan 8.6)
FR #3	Implement Year 1 of a 5 Year Rate Study to fund water and wastewater infrastructure improvements. (Comp Plan 2.2; 2.4)
FR #4	Implement Year 1 of Water System Maintenance Program. (Comp Plan 2.5)

Fiscal Responsibility cont.

FR #5	Implement Year 2 of smoke testing schedule for annual identification of wastewater inflow and infiltration. (Comp Plan 2.5)
FR #6	Implement Year 1 of Wastewater System Maintenance Program. (Comp Plan 2.5)
FR #7	Develop Wholesale Water Rate Category.
FR #8	Develop Wholesale Wastewater Rate Category.
FR #9	Adopt standardized Wholesale Water Agreement.
FR #10	Adopt standardized Wholesale Wastewater Agreement.
FR #11	Conduct a perpetual care actuarial study for Fairview Cemetery to ensure long-term financial sustainability. (Comp Plan 3.2)
FR #12	Complete the redesign of the Hotel Occupancy Fund Community Program Funding Policy & Application to better leverage resources and maximize the visitors' experience. (Comp Plan 8.1)
FR #13	Update Equipment Replacement Schedule and review replacement policies with Council. (Comp Plan 3.1)
FR #14	Evaluate convention center rental rates based on 2-year history and actual costs of service. (Comp Plan 8.3.2)
FR #15	Complete Hunters Crossing Local Government Corporation & Public Improvement District statutory audit and implement recommendations.
FR #16	Receive transparency star for Public Pension from Comptroller's Office.
FR #17	Build Five (5) Year Financial Model, identify opportunities and threats, and anticipate organizational growth based on increased population and development.
FR #18	Evaluate need for centralized Procurement position in FY 20 budget.

Manage Growth

Plan for and manage growth, development, and redevelopment to maintain Bastrop's authentic feel and character.

MG #1	Update Zoning and Sign Ordinances (Phase 1 – Code Update) to be fiscal sustainable and geographically sensitive and in alignment with Comprehensive Plan. (Comp Plan 5.2)
MG #2	Update technical criteria manual (Phase 2 – Code Update) including construction standards, review and modifications to subdivision ordinance and development process to align with updated development codes and Comprehensive Plan. (Comp Plan 5.2)
MG #3	Develop Annexation plan and corresponding Development Plan. (Comp Plan 2.1.1)
MG #4	Adopt an Interlocal Agreement that establishes development standards for the City's ETJ in partnership with Bastrop County. (Comp Plan 2.1.2)

Multi-Modal Mobility

Improved mobility for all modes of transit to integrate the community through connectivity.

MM #1	Complete gaps in residential sidewalks for traffic safety in the downtown corridor. (Comp Plan 6.2)
MM #2	Complete the downtown trail expansion in partnership with Bastrop Economic Development Corporation. – <i>CIP Quality of Life Project</i> (Comp Plan 7.1.3, 8.2.2)
MM #3	Complete trail to Bastrop State Park and partner with TxDOT to ensure safe pedestrian crossing at SH 95 & Loop 150. – <i>CIP Quality of Life Project</i>
MM #4	Address mobility challenges on west side of river on the north and south sides of SH 71. (Comp Plan 6.2.4)

Organizational Excellence

Organize governance; progressive operational policies and procedures; employee and citizen volunteer recognition.

OE #1	Develop an organization-wide strategy to be paperless by 2021. (Comp Plan 3.1)
OE #2	Continue completion of tasks necessary to obtain Texas Police Chiefs' Recognition Program. (Comp Plan 3.1)
OE #3	Create a secured records storage area.
OE #4	Develop indexing system for Council Meeting Video Archives using LaserFiche.
OE #5	Create a record retention policy.
OE #6	Develop a comprehensive internal records management system and policies for all Planning & Zoning case files.
OE #7	Complete award process for financial advisor services.
OE #8	Develop a 10-year building maintenance plan including inspections and annual contracts. (Comp Plan 3.2)
OE #9	Develop a 10-year park maintenance plan including inspections and annual contracts. (Comp Plan 3.2, 7.2)
OE #10	Develop and fund a Citywide Network Systems Replacement Schedule. (FY 2019 - FY 2021) (Comp Plan 3.2)
OE #11	Complete City Hall Renovation. (Comp Plan 3.1)
OE #12	Hire a Construction Inspector and other key personnel funded in FY 2019.
OE #13	Convert all on-line forms on website to a fillable pdf format.
OE #14	Amend Appendix B – Comprehensive Plan to reflect Council's preference for creation of a Capital Improvement Program.
OE #15	Evaluate police vehicles for fleet replacement in FY 2020 including the establishment of evaluation criteria.

Unique Environment

Continue beautification of natural areas, parks, river, and landscape.

UE #1	Install planter boxes, once completed by Cedar Creek High School, to support downtown beautification program. (Comp Plan 8.2)
UE #2	Partner with the Federal Corrections Institute to maintain landscape projects at the City's gateways and clean-up of Gills Branch.
UE #3	Create memorial tree program for Fairview Cemetery. (Comp Plan 7.1)
UE #4	Develop plan to lease or purchase rights-of-way owned by Union Pacific to improve aesthetics in highly visible locations.
UE #5	Institutionalize Adopt-a-Street Program in partnership with Keep Bastrop County Beautiful.
UE #6	Support community-wide brand identity efforts led by Visit Bastrop. (Comp Plan 8.5.1)

Comprehensive Plan

Goals & Objectives

Bastrop Comprehensive Plan 2036 was adopted in November 2016 and serves as only the second Comprehensive Plan adopted by the City. The first plan, Bastrop Comprehensive Plan 2020, was adopted in 2001. Much had changed in the community during this 15 year period. Therefore, an extensive citizen engagement process was initiated including over 2,545 cumulative survey responses throughout the planning process. The online response to the survey elicited responses from 975 city residents, which is a response rate of nearly 14% of Bastrop's total population. There is a strong commitment on the part of Bastrop's current Council to ensure this document serves as a significant cornerstone to the strategic planning initiatives under taken by the organization. This document highlights the adopted goals and any anticipated or completed progress.

Community Growth

Goal 2.1 - Maintain and enable a policy of “measured growth” as represented by the Bastrop Growth Program.



Goal 2.1 Status – In Progress - FY 2020 Completion

City Council has taken the following action to achieve this goal:

- Created an initiative known as “Building Bastrop” to guide responsible development that honors our authentic past and prepares for our sustainable future.
- Established requirement that all codes take a holistic approach to create geographically-sensitive, fiscally sustainable development in the future.
- Implemented a Drainage Moratorium on all development to stop all development that is detrimental to community.
- Hired Simplecity Design (SCD) to update all existing land-use and development related codes and align them to the Comprehensive Plan.
- Protecting Bastrop's authentic past by “coded the DNA” of Downtown Bastrop to document regulations that work and have proven to be sustainable for more than a century.
- Updating Zoning Ordinance and Sign Ordinance by mid-March 2019.
- Updating all development-related codes by December 31, 2019.
- Funded the development of a Fiscal Impact Analysis model to ensure financial sustainability in FY 2019.
- Updating Interlocal 1445 Agreement with Bastrop County that establishes development standards in City's ETJ.

Goal 2.2 - Ensure long-term water system capacity and water quality for existing customers while accommodating incremental growth and development.

Goal 2.2 Status – In Progress - FY 2021 Completion

City Council has taken the following action to achieve this goal:

- Authorized purchase of additional 3,000-acre feet of water, for a total of 7,613-acre feet in Simsboro Aquifer.
- Reached consensus at March 24, 2018 Special Workshop to build consolidated water treatment plant that treats for improved aesthetics in water quality and purchase wholesale water from Aqua Water Corporation to manage excess demand until plant is complete.
- Approved Engineering Scope of Service with Freese & Nichols on September 11, 2018 to design and manage construction of consolidated water treatment plant at XS Ranch and distribution lines to Willow Plant.
- Estimated timeline for water plant production is FY 2021.

Goal 2.3 - Mitigate expected increases in water demand through enhanced conservation practices.

Goal 2.3 Status – No Action

Goal 2.4 - Expand wastewater collection and treatment capacity in a cost-effective manner

Goal 2.4 Status – In Progress – FY 2021 Completion – Phase 1

City Council has taken the following action to achieve this goal:

- Reached consensus at March 24, 2018 Special Workshop to build a consolidated activated sludge wastewater treatment facility on 26-acre site, owned by City of Bastrop for this purpose.
- Approved Engineering Scope of Service with KSA Engineering on August 28, 2018 to design and manage construction of consolidated wastewater treatment plant and related distribution system.
- Construction of Phase 1 will begin before September 1, 2019 for Phase 1, a 2-million-gallon facility.
- Design of Phase 2, a 2nd 2-million-gallon facility, will immediately start upon completion of Phase 1.

Goal 2.5 - Enhance Wastewater System Efficiency.

Goal 2.5 Status – Completed Planning; Ongoing Implementation

The following action has been taken to achieve this goal:

- Developed a 10-year replacement schedule for all pumps, lift stations, and manholes, which is fully funded in the adopted rates. Year 1 will be implemented in FY 2019.
- Evaluating all wastewater collection lines associated with failed streets to be replaced at time of street reconstruction. Identified wastewater lines to be replaced as a part of North Bastrop Community Rehabilitation Project in FY 2019.
- Developed three (3) year plan to routinely test for Inflow & Infiltration into wastewater system. Completed Year 1 in FY 2018 by testing 56,000 feet and identifying/fixing 166 deficiencies.

Goal 2.6 - Reduce Flood Hazards in Bastrop through the programmed improvement of the City storm water system.

Goal 2.6 Status – On-Going

City Council has taken the following action to achieve this goal:

- Received Drainage Study from Halff Associates on February 20, 2018.
- Enacted a Drainage Moratorium on August 14, 2018.
- Updating land-use policies to be geographically sensitive including low-impact development standards, which will include findings from Atlas 14 maps, when available.
- Approved Engineering Scope of Service with Halff Associates to evaluate existing regulations with new findings to determine “gap” in drainage calculation requirements.
- Funded City’s match for three (3) drainage improvement programs including Public Works Detention Pond, Pine Street Drainage Improvements, and Jasper/Newton Drainage Improvements. All 3 projects anticipated to start construction in FY 2020.

Goal 2.7 - Protect water quality in the Lower Colorado River Watershed by mitigating storm water discharges associated with growth and development.

Goal 2.7 Status – In Progress

City Council has taken the following action to achieve this goal:

- Requiring low impact development standards as a part of updating development code regulations.

Public Facilities

Goal 3.1 - Provide adequate and appropriate public facilities and services to maintain the safety and quality of life for residents, visitors, and workers in Bastrop.

Goal 3.1 Status – Ongoing

The following action has been taken to achieve this goal:

- Funded renovations in FY 2019 budget at City Hall to improve Planning & Zoning space and add additional offices.
- Funded feasibility study to evaluate long-term fire service in Bastrop and related facilities in FY 2019.
- Will include a Public Works facility study in FY 2020 budget for inclusion in a future CIP.
- Conducted over 2,350 hours of emergency management training organization-wide in FY 2018.
- Updating Equipment Replacement Schedule and reviewing replacement policies with Council – FY 2019.
- Completing necessary tasks to obtain Texas Police Chiefs' Recognition Program – FY 2019.

Goal 3.2 - Improve the long-term fiscal and environmental efficiency of public facilities.

Goal 3.2 Status – Ongoing

The following action has been taken to achieve this goal:

- Hired additional staff in FY 2019 to implement citywide electronic records management. In addition to adding much needed staff capacity, additional space will be freed up in all facilities that will no longer be required for physical records storage.
- Conducting a perpetual care actuarial study for Fairview Cemetery in FY 2019 to ensure long-term financial sustainability.
- Developing a 10-year building maintenance plan including inspections and annual contracts in FY 2019.
- Developing a 10-year park maintenance plan including inspections and annual contracts in FY 2019.
- Developing a Citywide Network Systems Replacement Schedule in FY 2019.

Goal 3.3 - Engage in partnership with other public entities to maximize the utilization of and accessibility to public buildings and grounds.

Goal 3.3 Status – Ongoing
City Council has taken the following action to achieve this goal: <ul style="list-style-type: none">• Expanded YMCA contract in FY 2019 to include Movies in the Park and two (2) sessions of tennis lessons, which will be held at Bastrop Independent School District (BISD) facilities.• Approved a lease to the Bastrop Senior Center in FY 2018 of the Bastrop Activity Center (i.e. Emergency Shelter) for senior programming in turn for assistance when providing shelter services.• Approved an Adopt-a-Street Program with Keep Bastrop County Beautiful, who have adopted 12 streets since inception in early 2018.• Funding a Partnership Agreement with Bastrop County Long-Term Recovery Team to provide support services to Bastrop Emergency Shelter in times of emergency situations – FY 2019.



Goal 4.1 - Provide a greater diversity of housing options in Bastrop while protecting the character of the City's existing neighborhoods.

Goal 4.1 Status – On-going
City Council has taken the following action to achieve this goal: <ul style="list-style-type: none">• Council approved a Resolution of No Objection supporting The Preserve at Hunters Crossing, LP, a development of 140 affordable rental housing units, on property zoned for multi-family development.

Goal 4.2 – Maintain the overall quality of existing housing stock in Bastrop.

Goal 4.2 Status - No Action
.

Goal 4.3 - Develop housing targets that align with local demand.

Goal 4.3 Status – No Action
.

Goal 4.4 - Provide home ownership opportunities to Bastrop's low-to-moderate income and special needs populations

Goal 4.4 Status - No Action
.

Goal 4.5 - Maintain or enhance the health of Bastrop's older and historic neighborhoods.

Goal 4.5 Status – On-Going

The following action has been taken to achieve this goal:

- Strengthened Local Preservation Ordinance in FY 2018.
- Established goal to obtain Certified Local Government designation in FY 2019.
- Established goal to create a Code Enforcement Strategic Plan with an education component upon completion of Phase I Code Updates – FY 2019 Work Plan.
- Will re-institute downtown incentive grant program in FY 2019 in partnership with Bastrop Economic Development Corporation.

■ Land Use and Community Image ■

Goal 5.1 -- Utilize the Future Land Use Plan to guide decisions regarding proposed development and redevelopment activities in Bastrop and the City's ETJ.

Goal 5.1 - Status – On-going

The following action has been taken to achieve this goal:

- Planning & Zoning Staff reference the Future Land Use Plan in all staff reports, which provides basis for recommendations to Planning & Zoning Commission and City Council.
- The Future Land Use Plan will be incorporated into the Code Updates – Phase I and II, updated the zoning ordinance and technical design standards.

Goal 5.2 – Enhance community character and design through the amendment of city land development regulations and projects to improve the function and aesthetics of public properties.

Goal 5.2 - Status – In Progress – FY 2020 Completion

City Council has taken the following action to achieve this goal: (Please see Goal 2.1 for additional information)

- Funded Code Update – Phase 1 in FY 2019, which will include updating Zoning and Sign Ordinances, to be fiscally sustainable and geographically sensitive and in alignment with Comprehensive Plan. Estimated completion date is March 2019.
- Funded Code Update – Phase 2 in FY 2019, which will include updating technical criteria manual including construction standards, review and modifications to subdivision ordinance and development process to align with updated development codes (Phase 1) and Comprehensive Plan. Estimated completion date is December 2019.
- TxDOT has created landscaped gateways at SH 71 & Tahitian and SH 71 & Childers.

■ Transportation ■

Goal 6.1 - Manage traffic congestion and improve system reliability.

Goal 6.1 - Status – On-going

The following action has been taken to achieve this goal:

- TxDOT completed overpass improvements at SH 71 and SH 95, which significantly improved traffic congestion.
- TxDOT will award bids for SH71 Package 4 in May 2019: Phase 1- Construction of service roads over the Colorado River – Estimated completion 8 -12 months; Phase 2 – Main Lane Construction; Phase 3 – Old Bridge demolition. Completion – 2022.

Goal 6.2 – Enhance transportation system connectivity.

Goal 6.2 - Status – On-going

The following action has been taken to achieve this goal:

- BEDC is constructing Agnes Street from SH 304 to the eastern boundary of the Seton Hospital property.
- BEDC staff are negotiating with property owners along the aligned Agnes route to complete this connection as development occurs.

Goal 6.3 - Preserve and maintain existing transportation assets.

Goal 6.3 - Status – On-going

The following action has been taken to achieve this goal:

- Completed a Pavement Condition Index Study in January 2018.
- Developed a multi-year Street Maintenance Program to “Keep the Good Streets Good.”
- Funded Year 1 and 2 of the Street Maintenance Program in the 2018 Certificate of Obligations Series.
- Implementing Year 1 of Street Maintenance Program in FY 2019.
- Reconstructing Main Street from Water Street to Spring Street as a part of the Main Street Rehabilitation Project.
- Reconstructing multiple sections of failing streets including parts of Maple, Magnolia, and Locust as a part of North Main Community Rehabilitation Project.

Goal 6.4 – Improve the safety of the Bastrop Transportation System for all users.

Goal 6.4 - Status – On-going

The following action has been taken to achieve this goal:

- Ensuring compliance with City’s access management policies during site plan review on all development.
- Utilize traffic counter data, provided by Public Works, to address identified priority locations for targeted enforcement of speeding and other unsafe behaviors by the Police Department on an as needed basis.

Goal 6.5 – Improve active transportation options.

Goal 6.5 - Status – On-going

The following action has been taken to achieve this goal:

- Completing gaps in residential sidewalks for traffic safety in the downtown corridor – FY 2019.
- Addressing ADA enhancements along Main Street as a part of the Main Street Rehabilitation Program, which is considered a high pedestrian traffic corridor.

Goal 6.6 – Expand and enhance transit services.

Goal 6.6 - Status – On-going

The following action has been taken to achieve this goal:

- Interlocal Agreement with CARTS was executed in FY 2018.
- A bus stop has been designed at Spring/Main Streets. Project has been put on-hold pending completion of Main Street Rehabilitation Project.

Goal 6.7 – Enhance multi-modal freight capacity

Goal 6.7 - No action

Goal 6.8 – Build a network of complete streets and preserve quality of place.

Goal 6.8 - Status – In Progress – FY 2020 Completion

The following action has been taken to achieve this goal:

- Phase I and II of the Code Updates will address street cross sections, which will incorporate Complete Streets principles – December 2019.
- Pop-up example of Main Street Rehabilitation project will be utilized after design, but prior to construction, to show context of public space, sidewalks, and roadway. – FY 2019

Goal 6.9 – Support the land use, economic development and urban design goals of the Comprehensive Plan.

Goal 6.9 - Status – In Progress – FY 2020 Completion

The following action has been taken to achieve this goal:

- Phase I and II of the Code Updates will address street cross sections, which will incorporate Complete Streets principles – December 2019.

■ Parks and Recreation ■

Goal 7.1 – Provide a sufficient amount of public park land and open space for current and future residents

Goal 7.1 - Status – On-going

The following action has been taken to achieve this goal:

- Pecan Park Developers have installed a linear trail along the Colorado River, providing access to homeowners and the public, and serving as a future trail connection.
- Council awarded Professional Services Agreement to Kimley-Horn on August 28, 2018 for the design and construction management of the rehabilitation of the Old Iron Bridge.
- Funding of \$2 million was included in the \$4.7 million Certificate of Obligations Series to rehabilitate the Old Iron Bridge.
- Construction of Downtown River Trail loop has been funded through a CAMPO Grant of \$485,000, Keep Bastrop County Beautiful - \$130,000; and BEDC - \$65,000. Pedestrian crossing over River will occur with the completion of the TxDOT Service Roads and the rehabilitation of Old Iron Bridge.
- One (1) mile State Park Trail between Bastrop State Park and Chestnut Street is fully funded and under design by MWM Design Group.

Goal 7.2 – Address current and future recreation needs through the provision and maintenance of indoor and outdoor recreational facilities.

Goal 7.2 - Status – On-going

The following action has been taken to achieve this goal:

- Developing a plan for private initiative to program and operate the City's rodeo arena – FY 2019.
- Developing a 10-year park maintenance plan including inspections and annual contracts – FY 2019.
- Building Skate Park – Phase 1 in Fisherman's Park – FY 2019.

Goal 7.3 – Meet future recreational demand through adjustments to the City's operational capacity.

Goal 7.3 - Status – No Action

Goal 7.4 – Ensure that residents have access to recreational opportunities through the equitable distribution of park land and open space.

Goal 7.4 - Status – On-going

The following action has been taken to achieve this goal:

- Park land is critical to creating a fiscally sustainable community. Open space and landscaping requirements will be addressed in the Code Update – Phase 1, scheduled for completion in March 2019. Amendments to Park and Open Space ordinances will occur as a result of the code update.

■ Cultural Arts and Tourism ■

Goal 8.1 – Leverage existing downtown assets to spur additional business activity.

Goal 8.1 - Status – On-going

The following action has been taken to achieve this goal:

- Provide funding from Hotel Occupancy Tax to support offerings provided by the Bastrop Museum & Visitor Center and the Bastrop Opera House on an annual basis.
- Partnering through Main Street with the Chamber and BEDC to launch an annual training calendar and resource opportunities – 300 participants completed at least 1 offering in FY 2018.
- Continuing downtown incentive grants in partnership with BEDC in FY 2019.

Goal 8.2 – Diversify supply chain of natural assets.

Goal 8.2 - Status – On-going

The following action has been taken to achieve this goal:

- See actions listed under Goal 7.1 for increased community access to Colorado River as noted in Objective 8.2.2.
- Partnering with Cedar Creek High School to build planter boxes to enhance walkability and curb appeal of Historic Downtown.

Goal 8.3 – Bolster family and heritage tourism assets.

Goal 8.3 - Status – On-going

The following action has been taken to achieve this goal:

- Increased rentals at the Bastrop Convention Center by 50% in FY 2018 over FY 2017, with repeat conventions booked through FY 20.
- Revised contracts, marketing materials, and time offerings making renting the Bastrop Convention Center competitive.
- Provide full-service rentals at the Bastrop Convention Center including catering services (through contractual services with outside vendors), room setups and teardowns, tablecloths, table decorations, and drink stations.
- Provide successful programming including Farm Street Opry monthly, Boogie Back to Bastrop annually, and Red White & You Dance annually.

Goal 8.4 – Create a long-term strategy for placement of visual and performing arts assets.

Goal 8.4 - Status – On-going

The following action has been taken to achieve this goal:

- After completion a Request for Proposal process through the Bastrop Art in Public Places (BAIPP), City hired Go Collaborative on March 13, 2018 to complete a Cultural Arts Master Plan, which will be completed in January 2019.
- Funding has been allocated in the FY 2019 budget to begin implementation immediately upon completion of the study.

Goal 8.5 – Strengthen Bastrop’s brand throughout the region and the rest of the country.

Goal 8.5 - Status – On-going

The following action has been taken to achieve this goal:

- Council approved a contract with Visit Bastrop on September 12, 2017 to provide specific services related to providing “brand” marketing for Bastrop as a destination, to serve as primary brand advocate, and to better utilize existing facilities.
- Visit Bastrop has created a robust website to enhance visitors’ experience.
- Visit Bastrop is completing a “branding” strategy for Bastrop, which should be implemented in Fall 2018.
- Continue ongoing development of the Bastrop visitor experience to include the community’s culinary and cultural assets.
- City continues relations and connectivity with the Hyatt Lost Pines Resort through various methods.

Goal 8.6 – Adjust City ordinances to accommodate arts, entertainment, and recreation uses; and to manage their impact on the community.

Goal 8.6 - Status – On-going

The following action has been taken to achieve this goal:

- A draft food truck ordinance was completed and reviewed by Planning & Zoning Commission in Spring 2018. All partners are working to address identified concerns. A Food Truck pilot program is scheduled in the fall to allow food trucks for 6-8 months, address any concerns, and adopt final ordinance.
- Revising Special Events Ordinance and Procedures to meet the City’s Financial Policy requirement of fees covering costs of service and streamline process for customers in FY 2019.



STAFF REPORT

MEETING DATE: November 13, 2018

AGENDA ITEM: 7

TITLE:

CITIZEN COMMENTS

At this time, three (3) minute comments will be taken from the audience on any topic. To address the Council, please submit a fully completed request card to the City Secretary prior to the beginning of the Citizens' Comment portion of the Council meeting. In accordance with the Texas Open Meetings Act, if a citizen discusses any item not on the agenda, City Council cannot discuss issues raised or make any decision at this time. Instead, City Council is limited to making a statement of specific factual information or a recitation of existing policy in response to the inquiry. Issues may be referred to City Staff for research and possible future action.

To address the Council concerning any item on the agenda, please submit a fully completed request card to the City Secretary prior to the start of the meeting.

It is not the intention of the City of Bastrop to provide a public forum for the embarrassment or demeaning of any individual or group. Neither is it the intention of the Council to allow a member of the public to slur the performance, honesty and/or integrity of the Council, as a body, or any member or members of the Council individually or collectively, or members of the City's staff. Accordingly, profane, insulting or threatening language directed toward the Council and/or any person in the Council's presence will not be tolerated.



STAFF REPORT

MEETING DATE: November 13, 2018

AGENDA ITEM: 8A

TITLE:

Consider action to approve City Council minutes from the October 23, 2018 regular meeting.

STAFF REPRESENTATIVE:

Lynda Humble, City Manager
Ann Franklin, City Secretary

BACKGROUND/HISTORY:

N/A

POLICY EXPLANATION:

Section 551.021 of the Government Code provides as follows:

- (a) A governmental body shall prepare and keep minutes or make a tape recording of each open meeting of the body.
- (b) The minutes must:
 1. State the subject of each deliberation; and
 2. Indicate the vote, order, decision, or other action taken.

FUNDING SOURCE:

N/A

RECOMMENDATION:

Consider action to approve City Council minutes from the October 23, 2018 regular meeting.

ATTACHMENTS:

- October 23, 2018, DRAFT Regular Meeting Minutes.

**BASTROP CITY COUNCIL
October 23, 2018**

The Bastrop City Council met in a Regular Meeting on Tuesday, October 23, 2018, at 5:00 p.m. at the Bastrop City Hall Council Chambers, located at 1311 Chestnut Street, Bastrop, Texas. Members present were Mayor Schroeder, Mayor Pro Tem Nelson and Council Members Ennis, Peterson and Rogers. Officers present were City Manager Lynda Humble, City Secretary Ann Franklin and City Attorney Alan Bojorquez.

WORK SESSION – 5:00 P.M.

At 5:00 p.m. Mayor Schroeder called the work session to order with a quorum being present.

- 1A. Receive Presentation and Discuss Findings of Development Code Assessment Analysis with Matt Lewis, Simple City Design.
Presentation was made by Matt Lewis, Simple City Design.

Council Member Jones arrived to the meeting at 5:08 p.m.

At 6:00 p.m. Mayor Schroeder recessed the work session.

REGULAR SESSION - CALL TO ORDER

At 6:30 p.m. Mayor Schroeder called the regular meeting to order with a quorum being present.

PLEDGE OF ALLEGIANCE

JP Castellanos and Gabriel Pina, Emile Elementary, STARS Program performed the pledge.

INVOCATION

Chaplain Dale Burke, Police Chaplain gave the invocation.

PRESENTATIONS

- 5A. Mayor's Report
- 5B. Councilmembers' Report
- 5C. City Manager's Report
- 5D. A proclamation of the City Council of the City of Bastrop, Texas and Bastrop County Commissioners' Court recognizing November 9, 2018 as Veterans Day.
Proclamation was read into record by Mayor Schroeder.
- 5E. A proclamation of the City Council of the City of Bastrop, Texas, recognizing November 2, 2018 as City of Bastrop Arbor Day.
Mayor Schroeder recognized Thomas Martinez on becoming a certified arborist.
Proclamation was read into record by Mayor Schroeder and received by David Junek.

WORK SESSION/BRIEFINGS

- 6A. Receive Presentation and update from Verdunity regarding the development of a Fiscal Impact Analysis Model.
Presentation was made by Kevin Shepherd, Founder and CEO, Verdunity
- 6B. Update on Chicken/Rooster relocation process in the downtown area.
Presentation was made by Safety Director / Chief of Police, James Altgelt.

Mayor Schroeder recessed the Council Meeting at 7:58 p.m.

Mayor Schroeder called the meeting back to order at 8:04 p.m.

STAFF AND BOARD REPORTS

- 7A. Receive monthly report from Visit Bastrop.
Presentation was made by Visit Bastrop President, Susan Smith.
- 7B. Receive presentation on the Quarterly Investment Report for the period ending September 30, 2018.
Presentation was made by Chief Financial Officer, Tracy Waldron.
- 7C. Receive report from Bastrop Economic Development Corporation.
Presentation was made by Bastrop Economic Development Corporation Director, Mike Kamerlander.

CITIZEN COMMENTS – NONE

CONSENT AGENDA

A motion was made by Council Member Ennis to approve Items 9A, 9B, and 9C listed on the Consent Agenda after being read into the record by City Secretary, Ann Franklin. Seconded by Mayor Pro Tem Nelson, motion was approved on a 5-0 vote.

- 9A. Consider action to approve City Council minutes from the October 9, 2018 meeting.
- 9B. Consider action to approve the second reading of Ordinance No. 2018-29 of the City Council of the City of Bastrop, Texas, Rezoning 1.95 acres of Building Block 62, East of Water Street, from SF-7, Single-Family 7 to C-1, Commercial 1, located at 303 and 305 Martin Luther King Jr. Drive, within the city limits of Bastrop, Texas; as shown in Exhibits A & B; including a severability clause; establishing an effective date.
- 9C. Consider action to approve the second reading of Resolution No. R-2018-102 of the City Council of the City of Bastrop, Texas, approving the terms of an economic development performance agreement between the Bastrop Economic Development Corporation and 921 Bastrop, LLC; approving the terms of an agreement for construction of improvements to the lot at 921 Main Street with 921 Bastrop, LLC, in an amount exceeding ten thousand dollars (\$10,000) attached as Exhibit A; repealing all resolutions in conflict; providing severability; and providing an effective date.

INDIVIDUAL CONSIDERATION

- 10A. Consider action and approve Resolution No. R-2018-108 of the City Council of the City of Bastrop, Texas, making determinations regarding certain project-specific Exceptions and/or Exemptions as provided by Emergency Ordinance 2018-1, Section 8 (Temporary Moratorium); and Emergency Ordinance 2018-2, Section 7 (Emergency Drainage Application Rules).

Presentation was made by Assistant Director of Planning and Zoning, Jennifer Bills.

A motion was made by Council Member Rogers to approve Resolution No. R-2018-108 for 463 Kaanapali Lane, seconded by Council Member Ennis, motion was approved on a 5-0 vote.

A motion was made by Council Member Peterson to approve Resolution No. R-2018-108 for Tahitian Drive Lot 1120, seconded by Council Member Jones, motion was approved on a 5-0 vote.

A motion was made by Mayor Pro Tem Nelson to approve Resolution No. R-2018-108 for Mauna Kea Lot 529, seconded by Council Member Ennis, motion was approved on a 5-0 vote.

- 10B. Consider action to approve Resolution No. R-2018-93 of the City Council of the City of Bastrop, Texas awarding a community support service agreement for services associated with operating, marketing and providing cultural art and theater services, to the Bastrop Opera House, at a cost of Ninety Two Thousand and Five-hundred and 00/100 dollars (\$92,500) attached as Exhibit A; authorizing the City Manager to execute all necessary documents for the contract; providing for a repealing clause; and establishing an effective date.

This item was pulled.

- 10C. Consider action to approve Resolution No. R-2018-94 of the City Council of the City of Bastrop, Texas awarding a community support service agreement for operating, marketing and staffing a historical museum and visitor center and providing visitor center services to the Bastrop County Historical Society, at a cost of One hundred and Forty-Six thousand and Nine-hundred and Thirty-Seven and 00/100 dollars (\$146,937) attached as Exhibit A; authorizing the City Manager to execute all necessary documents for the contract; providing for a repealing clause; and establishing an effective date.

This item was pulled.

- 10D. Consider action to approve Resolution No. R-2018-95 of the City Council of the City of Bastrop, Texas awarding a community support service agreement associated with providing recreation and pool services, to the Bastrop YMCA, at a cost of Seventy-Nine thousand and Eight-hundred and 00/100 dollars (\$79,800) attached as Exhibit A; authorizing the City Manager to execute all necessary documents for the contract; providing for a repealing clause; and establishing an effective date.

This item was pulled.

- 10E. Consider action to approve Resolution No. R-2018-107 of the City Council of the City of Bastrop, Texas, approving to extend the term of the current Bank Depository Agreement with First National Bank of Bastrop, from November 1, 2018 until December 31, 2018, attached as Exhibit A; authorizing the City Manager to execute all necessary documents; providing for a repealing clause; and establishing for an effective date.

Presentation was made by Chief Financial Officer, Tracy Waldron.

A motion was made by Council Member Jones to approve Resolution No. R-2018-107, seconded by Council Member Rogers, motion was approved on a 5-0 vote.

- 10F. Consider action to approve the first reading of Ordinance No. 2018-30 of the City Council of the City of Bastrop, Texas, amending the budget for the Fiscal Year 2019 in accordance with existing statutory requirements; appropriating the various amounts herein attached as Exhibit "A"; repealing all prior ordinances and actions in conflict herewith; providing for an effective date; and move to include on the November 13, 2018 City Council consent agenda for a second reading.

Presentation was made by Chief Financial Officer, Tracy Waldron.

A motion was made by Council Member Jones to approve Resolution No. R-2018-30 minus the \$19,000 for the Opera House, seconded by Council Member Rogers, motion was approved on a 5-0 vote.

EXECUTIVE SESSION

The City Council met at 9:02 p.m. in a closed/executive session pursuant to the Texas Government Code, Chapter 551, et seq, to discuss the following:

- 11A. City Council shall convene into closed executive session pursuant to Section 551.071 of the Texas Government Code to confer with City Attorney regarding legal advice related to the status of the 1445 Interlocal Agreement between the City of Bastrop and Bastrop County for the review of subdivision applications in the City's extraterritorial jurisdiction.
- 11B. City Council shall convene into closed executive session pursuant to Section 551.071 of the Texas Government Code to confer with City Attorney regarding legal advice related to the status of updating the city's regulatory program, including public comment and citizen input into the new subdivision ordinance, pending revisions to zoning and sign codes, and uniformity of the permitting process.
- 11C. City Council shall convene into closed executive session pursuant to Sections 551.071 and 551.074 of the Texas Government Code to confer with City Attorney regarding legal advice related to certain real property that being 2.07 acres of the former Linenberger parcel.

The Bastrop City Council reconvened at 10:29 p.m. into open (public) session.

TAKE ANY NECESSARY OR APPROPRIATE ACTION ON MATTERS POSTED FOR CONSIDERATION IN CLOSED/EXECUTIVE SESSION.

No action taken.

ADJOURNMENT

Adjourned at 10:30 p.m. without objection.

APPROVED:

ATTEST:

Mayor Connie B. Schroeder

City Secretary Ann Franklin

DRAFT



STAFF REPORT

MEETING DATE: November 13, 2018

AGENDA ITEM: 8B

TITLE:

Consider action to approve the second reading of Ordinance 2018-30 amending the budget for the Fiscal Year 2019 in accordance with existing statutory requirements; appropriating the various amounts herein as attached in Exhibit "A"; repealing all prior ordinances and actions in conflict herewith; and providing for an effective date.

STAFF REPRESENTATIVE:

Tracy Waldron, Chief Financial Officer

BACKGROUND/HISTORY:

Each year, there are items and or services that carry-over from one fiscal year to the next. These budget amendments are due to such carry-overs and increase the budget appropriations for Fiscal Year 2019. Funds included in these amendments are detailed below:

General Fund includes:

The Planning and Zoning department had budgeted for Phase II of the Energov software but was unable to move into that phase. This amount is being carried over to FY2019.

Innovation Fund:

The Votelynx system improvement for Council Chambers was budgeted in FY2018 but did not get completed and needs to be a carry-over into FY2019.

Water/Wastewater department includes:

The FY18 budget included an amount to purchase GIS equipment for documenting the water and wastewater lines. This was not completed in FY18 and is being re-appropriated for FY19.

Vehicle & Equipment Replacement Fund includes:

The budget in this fund should have been \$125,000 for water/wastewater but was entered as \$117,000 which was the amount being transferred from the water/wastewater fund. The difference was available fund balance in the VERF fund.

Bastrop Economic Development Corporation includes:

Agnus/Home Depot Way Street Improvement carry-over from FY2018 in Bond fund.

POLICY EXPLANATION:

The City Charter requires that when the budget is amended, that the amendment be made by Ordinance.

City Council approved the first reading of this Ordinance at the October 23, 2018 meeting.

FUNDING SOURCE:

N/A

RECOMMENDATION:

Consider action to approve the second reading of Ordinance 2018-30 amending the budget for the Fiscal Year 2019 in accordance with existing statutory requirements; appropriating the various amounts herein as attached in Exhibit "A"; repealing all prior ordinances and actions in conflict herewith; and providing for an effective date.

ATTACHMENTS:

- Ordinance 2018-30
- Exhibit "A"



ORDINANCE NO. 2018-30

AN ORDINANCE OF THE CITY COUNCIL OF THE CITY OF BASTROP, TEXAS, AMENDING THE BUDGET FOR THE FISCAL YEAR 2019 IN ACCORDANCE WITH EXISTING STATUTORY REQUIREMENTS; APPROPRIATING THE VARIOUS AMOUNTS HEREIN; REPEALING ALL ORDINANCES AND ACTIONS IN CONFLICT HEREWITH; AND PROVIDING FOR AN EFFECTIVE DATE.

WHEREAS, the City Manager of the City of Bastrop has submitted to the Mayor and City Council proposed amendment(s) to the budget of the revenues and/or expenditures/expenses of conducting the affairs of said city and providing a complete financial plan for Fiscal Year 2019; and

WHEREAS, the Mayor and City Council have now provided for and conducted a public hearing on the budget as provided by law.

NOW THEREFORE BE IT ORDAINED BY THE CITY COUNCIL OF THE CITY OF BASTROP, TEXAS THAT:

Section 1: That the proposed budget amendments for the Fiscal Year 2019, as submitted to the City Council by the City Manager and which budget amendments are attached hereto as Exhibit "A", are hereby adopted and approved as the amended budget of said city for Fiscal Year 2019.

Section 2: If any provision of this ordinance or application thereof to any person or circumstance shall be held invalid, such invalidity shall not affect the other provisions, or application thereof, of this ordinance, which can be given effect without the invalid provision or application, and to this end, the provisions of this ordinance are hereby declared to be severable.

Section 3: This ordinance shall take effect upon the date of final passage noted below, or when all applicable publication requirements, if any, are satisfied in accordance with the City's Charter, Code of Ordinances, and the laws of the State of Texas.

READ and APPROVED on First Reading on the 23RD day of October 2018.

READ and ADOPTED on Second Reading on the 13th day of November 2018.

APPROVED:

Connie B. Schroeder, Mayor

ATTEST:

Ann Franklin, City Secretary

APPROVED AS TO FORM:

Alan Bojorquez, City Attorney

Exhibit "A"
FY 2019
BUDGET AMENDMENTS
GENERAL FUND

Projected Fund Balance as of 9-30-18	\$	2,566,858
FY2019 Budgeted Revenues	\$	11,507,934
FY2019 Budgeted Expenses	\$	(11,507,934)
10/2018 Budget Amendments (net)	\$	(10,000)
Ending Fund Balance	\$	<u>2,556,858</u>

DEPARTMENT	BUDGET	AMOUNT	DESCRIPTION	ACCOUNT #
------------	--------	--------	-------------	-----------

New Revenue:

Matching Revenues to Expenditures:

Neutral	
Neutral	
Neutral	
Total Revenues	<u>\$0</u>

Matching Expenditures to Revenues:

New Expenditures:

Planning & Zoning	Increase	(\$10,000) Capital Outlay	101-15-00-6000
-------------------	----------	---------------------------	----------------

Total Expenditures	<u>(\$10,000)</u>
Net Change	(\$10,000)

**FY 2019
BUDGET AMENDMENTS
INNOVATION FUND**

Projected Fund Balance as of 9-30-18	487,500
FY 2019 Budgeted Revenues	2,557,101
FY 2019 Budgeted Appropriations	(2,372,895)
10/2018 Budget Amendment	<u>(15,247)</u>
Ending Fund Balance	<u>656,459</u>

	<u>BUDGET</u>	<u>AMOUNT</u>	<u>DESCRIPTION</u>	<u>ACCOUNT NUMBER</u>
--	---------------	---------------	--------------------	-----------------------

Matching Revenues to Expenditures:

Total Revenues 0

Matching Expenditures to Revenues:

New Expenditures:

Increase	(15,247)	Capital Outlay	105-00-00-6000
----------	----------	----------------	----------------

Total Expense (15,247)

Net Change (15,247)

**FY 2019
BUDGET AMENDMENTS
WATER/WASTEWATER FUND**

Projected Fund Balance as of 9-30-18	1,911,557
FY 2019 Budgeted Revenues	5,707,190
FY 2019 Budgeted Expenses	(5,679,868)
10/2018 Budget Amendments (net)	<u>(15,000)</u>
Ending Fund Balance	<u>1,923,879</u>

<u>BUDGET</u>	<u>AMOUNT</u>	<u>DESCRIPTION</u>	<u>ACCOUNT NUMBER</u>
---------------	---------------	--------------------	-----------------------

Matching Revenues to Expenditures:

Total Revenues 0

Matching Expenditures to Revenues:

Increase

New Expenditures:			
Distribution/Collection	Increase	(15,000)	Equipment, Capital Outlay
	Increase		202-35-41-6010
	Total Expense	<u>(15,000)</u>	
	Net Change	(15,000)	

**FY 2019
BUDGET AMENDMENTS
VEHICLE & EQUIPMENT REPLACEMENT FUND**

Projected Fund Balance as of 9-30-18	1,866,409
FY2019 Budgeted Revenues	611,563
FY2019 Budgeted Expenses	(400,764)
10/2018 Budget Amendments (net)	<u>(8,000)</u>
Ending Fund Balance	<u><u>2,069,208</u></u>

DEPARTMENT	BUDGET	AMOUNT	DESCRIPTION	ACCOUNT #
------------	--------	--------	-------------	-----------

Matching Revenues to Expenditures:

Total Revenue 0

Matching Expenditures to Revenues:

New Expenditures:

Water/Wastewater	Increase	(8,000)	Vehicles	380-00-00-6030
------------------	----------	---------	----------	----------------

Total Expense (8,000)
Net Change (8,000)

**FY 2019
BUDGET AMENDMENTS
BASTROP ECONOMIC DEVELOPMENT CORP. - BOND FUND**

Projected Fund Balance as of 9-30-18	878,466
FY 2019 Budgeted Revenues	0
FY 2019 Budgeted Expenses	0
10/2018 Budget Amendments (net)	<u>(878,466)</u>
Ending Fund Balance	<u><u>0</u></u>

DEPARTMENT	BUDGET	AMOUNT	DESCRIPTION	ACCOUNT #
------------	--------	--------	-------------	-----------

Matching Revenues to Expenditures:

Total Revenue 0

Matching Expenditures to Revenues:

New Expenditures:

Increase (878,466) Agnus/Home Depot Infrastructure 605-70-00-6716

Total Expense (878,466)

Net Change (878,466)



STAFF REPORT

MEETING DATE: November 13, 2018

AGENDA ITEM: 8C

TITLE:

Consider action to approve Resolution No. R-2018-111 of the City Council of the City of Bastrop, Texas, approving the Pecan Park, Section 3F Final Plat, being 1.758 acres out of the Mozea Rousseau Survey, Abstract 56, located east of the extension of Trailside Lane, within the city limits of Bastrop, Texas, as shown in Exhibit A; repealing all conflicting resolution; and providing an effective date.

STAFF REPRESENTATIVE:

Jennifer C. Bills, AICP, LEED AP, Assistant Planning Director

ITEM DETAILS:

Site Address: East of the extension of Trailside Lane (Attachment 1)
Total Acreage: 1.758 acres
Legal Description: 1.758 acres out of the Mozea Rousseau Survey, Abstract 56
Property Owner: Ranch Road Development, LLC/Scott Miller
Agent Contact: Carlson, Brigance, & Doering/Christine Methvin
Existing Use: Vacant/Undeveloped
Existing Zoning: Pecan Park Residential Planned Development
Planned Development: Single-Family Patio Homes (PD PH)
District:
Future Land Use: Neighborhood Residential

BACKGROUND/HISTORY:

The applicant has submitted a Final Plat for the Pecan Park, Sections 3F. The Preliminary Plat that includes this section was approved on July 10th as Pecan Park, Sections 3B-3E. Section 3F is 10 single-family lots out of Section 3E that they are platting to construct with Section 1A to make the connection between Driftwood Lane and Trailside Lane (Exhibit A). The single-family detached lots allowed under the Single-Family Patio Home district of the Planned Development and have a minimum width of 40 feet and a minimum of 4,600 square feet in size. 480 linear feet of street will be dedicated for Trailside Lane, which will be 50-foot wide residential local collector right-of-way.

Traffic Impact and Streets

The Final Plat proposes to extend Trailside Lane, a residential local collector street, southwestward to provide the connection from Driftwood Lane in Section 1A to the exiting development. Sidewalks will be installed along all proposed streets, and will connect to the proposed neighborhood trail system. The Public Improvement Construction Plans have been reviewed and have been tentatively approved, pending City Council approval of the Final Plat.

Utilities

Water service (domestic and fire) will be provided by the City via water line extensions from existing infrastructure located on Childers Drive. These lines will be designed according to the City's construction standards, as well as the Texas Commission on Environmental Quality's (TCEQ) requirements.

Wastewater collection and treatment will also be provided by the City, and will require the installation of lines that will ultimately connect to an existing wastewater lift station.

There is an existing LCRA substation and electrical easement to the north of the proposed subdivision. The applicant received a subdivision variance on November 12, 2014 to eliminate the requirement for 50 foot setback from high voltage transmission lines.

Drainage

The Public Improvement Construction Plans that were reviewed with the Final Plat proposes to install an underground storm sewer system designed to drain runoff generated from the development into an existing system located adjacent to Section 6B. The existing system was designed to accommodate this increase in peak flows, and ultimately connects to the Colorado River.

The proposed drainage system will be designed with a sufficient capacity to route flows from a 100-year design storm to the Colorado River. Due to the property's close proximity to the river, stormwater detention is not required.

PUBLIC COMMENTS:

Notifications to adjacent property owners within 200 feet were mailed on October 30, 2018 (Attachment 3).

POLICY EXPLANATION:

All Final Plats must be reviewed by the Planning & Zoning Commission and are then forwarded to City Council for approval.

Compliance with 2036 Comprehensive Plan:

- Future Land Use Plan - Neighborhood Residential: The Neighborhood Residential character area is for single-family residential subdivision development, associated amenities such as parks, trails, open spaces and public uses such as schools, fire stations, and more.

This final plat complies with the Future Land Use Plan. The plat includes 10 single-family lots that will provide single-family detached units. This section is part of the Pecan Park development, in which the total development includes multiple phases that include parks, trails, and recreation facilities.

- Objective 2.4.1: Invest in waste water system expansion in areas that promote infill and contiguous development.

This development is within the City's wastewater service area and is vacant land immediately adjacent to existing development. This subdivision connects to existing wastewater lines and continues the system in an efficient manner

- Goal 4.1.1 Provide a greater diversity of housing options in Bastrop while protecting the character of the City's existing neighborhoods.

The Pecan Park Development includes six different residential lot standards. This plat utilizes the Single Family Patio Home district, which allows a minimum of 4,800 square foot lots with reduced rear and side setbacks to allow various single-family product types and with varied 20 and 25 foot front setbacks to provide visual appeal.

Local Government Code

- Sec. 212.002. Rules.

After a public hearing on the matter, the governing body of a municipality may adopt rules governing plats and subdivisions of land within the municipality's jurisdiction to promote the health, safety, morals, or general welfare of the municipality and the safe, orderly, and healthful development of the municipality.

Bastrop adopted subdivision regulations in 1981. The Code of Ordinances, Chapter 10 – Subdivisions outlines the requirements for plats within the Bastrop city limits and Extra Territorial Jurisdiction (ETJ).

Section 212.004 Plat Required

- (a) The owner of a tract of land located within the limits or in the extraterritorial jurisdiction of a municipality who divides the tract in two or more parts to lay out a subdivision of the tract, including an addition to a municipality, to lay out suburban, building, or other lots, or to lay out streets, alleys, squares, parks, or other parts of the tract intended to be dedicated to public use or for the use of purchasers or owners of lots fronting on or adjacent to the streets, alleys, squares, parks, or other parts must have a plat of the subdivision prepared.

The applicant has proposed dividing up an undeveloped 1.758 acre tract into 10 single-family lots. Public improvements within the subdivision (streets, drainage, and other utilities) will be dedicated to the City upon their completion.

- Sec. 212.010. Standards for Approval

- (a) The municipal authority responsible for approving plats shall approve a plat if:
 - (1) it conforms to the general plan of the municipality and its current and future streets, alleys, parks, playgrounds, and public utility facilities;

The final plat conforms to the Future Land Use Plan, which is designated Neighborhood Residential for this area.

- (2) it conforms to the general plan for the extension of the municipality and its roads, streets, and public highways within the municipality and in its extraterritorial jurisdiction, taking into account access to and extension of sewer and water mains and the instrumentalities of public utilities;

The plat conforms to the adopted Transportation Master Plan. The extension of Trailside Lane will be dedicated with this plat. The plat also conforms to the Capital Improvement Plan and will install public extensions of the water and wastewater infrastructure.

- (3) a bond required under Section 212.0106, if applicable, is filed with the municipality; and

Required improvements and bonds will be furnished before the approval of the Final Plat.

- (4) it conforms to any rules adopted under Section 212.002.

The final plat complies with the requirements of the adopted Subdivision Ordinance.

Code of Ordinances Chapter 10 – Subdivisions

- Section 4.20 – Standard Procedure – Final Plat

4.20.1 Submission

- C. The final plat shall be filed with the Director of Planning and Development at least fifteen (15) days prior to the meeting at which approval is requested. Prior to the plat being placed before the Council for consideration, the plat must be accepted as administratively complete by the Director of Planning and Development. A plat that contains the information set forth in paragraph 4.20.2 is considered complete.

Planning and Engineering staff have reviewed the Pecan Park Section 3F Final Plat for compliance with subdivision and utility standards, have deemed the plat administratively complete and that it meets all of the Subdivision Ordinance requirements.

- D. The Director of Planning and Development will mail a notice to each property owner named as required by Section 4.10.1A hereof each and every time that a subdivision proposal is pending before the City Planning and Zoning Commission or City Council which notice shall include the date, place and time of each subdivision, consideration.

A mailed notice was sent to all property owners within 200 feet on October 30, 2018.

RECOMMENDATION:

Consider action to approve Resolution No. R-2018-111 of the City Council of the City of Bastrop, Texas, approving the Pecan Park, Section 3F Final Plat, being 1.758 acres out of the Mozea Rousseau Survey, Abstract 56, located east of the extension of Trailside Lane, within the city limits of Bastrop, Texas, as shown in Exhibit A; repealing all conflicting resolution; and providing an effective date.

ATTACHMENTS:

Resolution

Exhibit A: Final Plat

Attachment 1: Location Map

Attachment 2: Surrounding Property Owner Notification

RESOLUTION NO. R-2018-111

A RESOLUTION OF THE CITY COUNCIL OF THE CITY OF BASTROP, TEXAS, APPROVING THE PECAN PARK, SECTION 3F FINAL PLAT, BEING 1.758 ACRES OUT OF THE MOZEA ROUSSEAU SURVEY, ABSTRACT 56, LOCATED EAST OF THE EXTENSION OF TRAILSIDE LANE, WITHIN THE CITY LIMITS OF BASTROP, TEXAS, AS SHOWN IN EXHIBIT A; REPEALING ALL CONFLICTING RESOLUTION; AND PROVIDING AN EFFECTIVE DATE.

WHEREAS, pursuant to the Texas Local Government Code Section 212 and the City of Bastrop Subdivision Ordinance, the City Council is required to take action regarding certain plats; and

WHEREAS, Ranch Road Development L.L.C. (“the Applicant”) has submitted a Final Plat for Pecan Park Section 3F, a residential subdivision; and

WHEREAS, the Final Plat is consistent with the Comprehensive Plan designation of Neighborhood Residential and requirements of the Pecan Park Planned Development (Ord # 2017-14); and

WHEREAS, the Preliminary Plat for Pecan Park Section 3B, 3C, 3D, & 3E (Section 3F is a portion of Section 3E) was recommended for approval by the Planning & Zoning Commission on June 28, 2018 and City Council on July 10, 2018; and

WHEREAS, the Bastrop Planning and Development Department has reviewed the above-referenced Final Plat and found it is in compliance with the Subdivision Ordinance, and the Pecan Park Planned Development (Ord # 2017-14) standards; and

WHEREAS, notice of the subdivision was sent in accordance with the Subdivision Ordinance to notify the public.

NOW, THEREFORE, BE IT RESOLVED BY THE CITY COUNCIL OF THE CITY OF BASTROP, TEXAS:

Section 1. The Final Plat known as the Pecan Park Section 3F, being 1.758 acres of the Mozea Rousseau Survey, Abstract 56, located east of the future extension of Trailside Lane, within the city limits of Bastrop, Texas is hereby approved, a copy of same being attached hereto as Exhibit “A” and incorporated herein for all purposes.

Section 2: All orders, ordinances and resolutions, or parts thereof, which are in conflict or inconsistent with any provision of this Resolution are hereby repealed to the extent of such conflict, and the provisions of this Resolution shall be and remain controlling as to the matters resolved herein.

Section 3: This ordinance shall take effect upon passage and in accordance with the laws of the State of Texas.

DULY RESOLVED AND ADOPTED by the City Council of the City of Bastrop this 13th day of November, 2018.

CITY OF BASTROP, TEXAS

APPROVED:

Connie B. Schroeder, Mayor

ATTEST:

Ann Franklin, City Secretary

APPROVED AS TO FORM:

Alan Bojorquez, City Attorney

THE FINAL PLAT OF PECAN PARK SECTION 3F

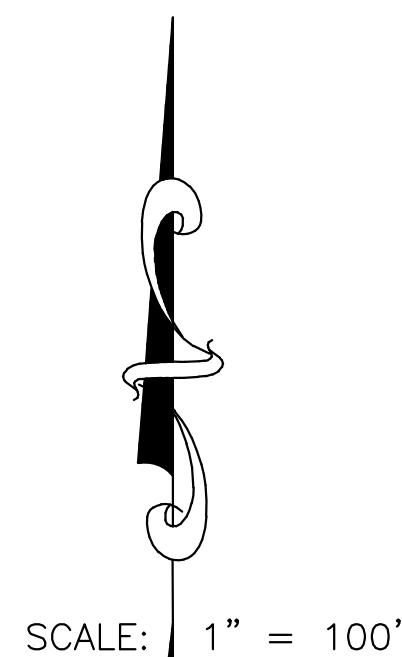
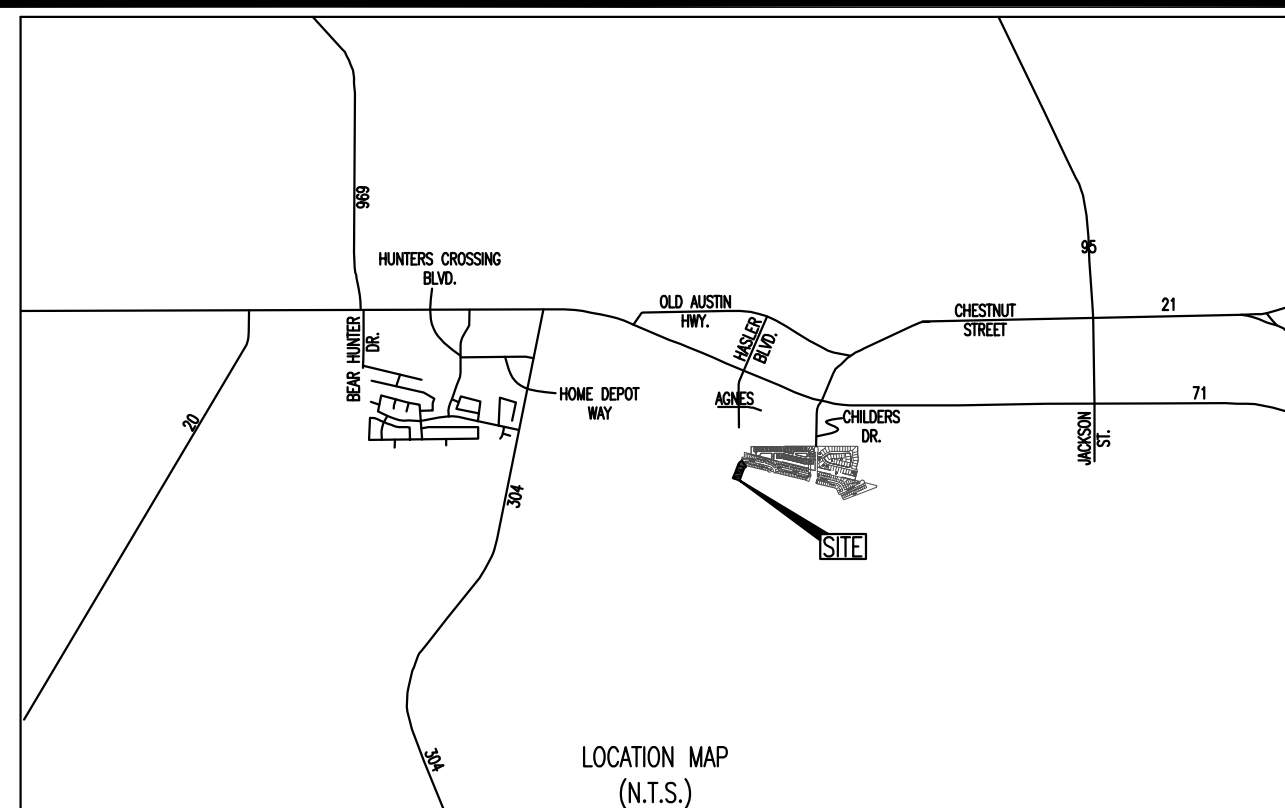

SCALE: 1" = 100'

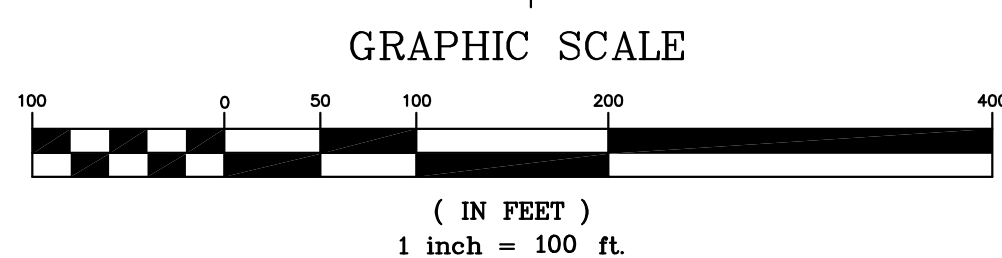

LEGEND

- 1/2" CAPPED IRON ROD SET
- CAPPED IRON ROD FOUND (UNLESS OTHERWISE NOTED)
- 2 LOT NUMBER
- Ⓐ BLOCK LETTER
- L.S.E. LANDSCAPE EASEMENT
- APPROXIMATE FEMA 100 YEAR FLOODPLAIN
- B.L. BUILDING LINE
- P.U.E. PUBLIC UTILITY EASEMENT



Curve Table						
Curve #	Length	Radius	Chord Direction	Chord Length	Tangent	DELTA
C1	136.35	225.00	N37°30'07"E	134.27	70.34	34°43'17"
C2	106.05	175.00	S37°30'07"W	104.43	54.71	34°43'17"
C3	94.48	175.00	S38°23'48"W	93.33	48.42	30°55'56"
C4	11.57	175.00	S22°02'10"W	11.57	5.79	3°47'21"

Line Table		
Line #	Length	Direction
L1	14.99	S30°54'42"E
L2	59.96	S44°31'50"W
L3	130.58	N69°51'48"W
L4	3.86	S20°08'29"W
L5	50.00	N69°51'31"W

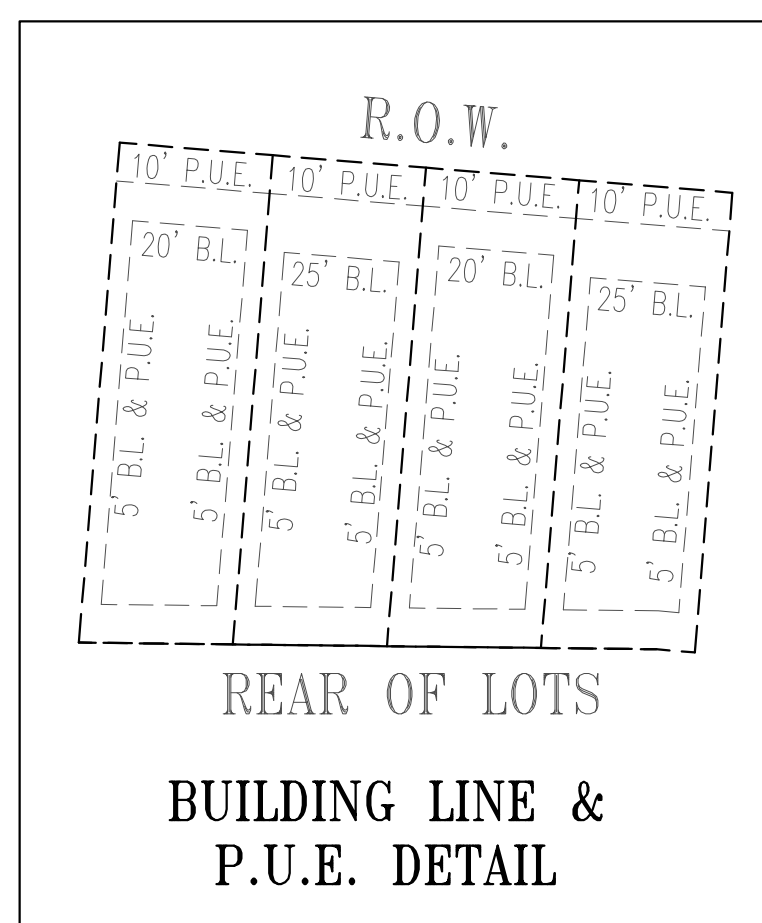

LINEAR FOOTAGE OF RIGHT-OF-WAY			
TRAILSIDE LANE	50' R.O.W.	480 FT	LOCAL
TOTAL		480 FT	

DATE: OCTOBER 11, 2018

OWNER:
RANCH ROAD DEVELOPMENT, LLC.
3140 DYER STREET, SUITE 624
DALLAS, TEXAS 75275

ENGINEER & SURVEYOR:
CARLSON, BRIGANCE & DOERING, Inc.
5501 WEST WILLIAM CANNON
AUSTIN, TX 78749
(512) 280-5160
(512) 280-5165 fax

TOTAL ACREAGE: 1.758 ACRES
SURVEY: MOZEA ROUSSEAU SURVEY, ABSTRACT No. 56

RESIDENTIAL LOTS: 10 TOTAL: 1.207 ACRES

NO. OF BLOCKS: 1 TOTAL: 0.551 ACRES
R.O.W.:

F.E.M.A. MAP NO. 48021 C 0355E
BASTROP COUNTY, TEXAS DATED: JANUARY 19, 2006

SHEET NO. 1 OF 2 (AP)



Carlson, Brigance & Doering, Inc.

FIRM ID #13791 REG. # 10024900

Civil Engineering 5501 West William Cannon Phone No. (512) 280-5160	Surveying Austin, Texas 78749 Fax No. (512) 280-5165
---	--

THE FINAL PLAT OF PECAN PARK SECTION 3F

STATE OF TEXAS §
COUNTY OF BASTROP § KNOW ALL MEN BY THESE PRESENTS:

THAT, RANCH ROAD DEVELOPMENT LLC, _____ ACTING HEREIN BY AND THROUGH AND BEING THE OWNER OF THAT CERTAIN 174.334 ACRE TRACT OF LAND AS CONVEYED TO RANCH ROAD DEVELOPMENT, LLC., IN DOCUMENT NUMBER 201717048, OFFICIAL PUBLIC RECORDS OF BASTROP COUNTY, TEXAS, OUT OF THE MOZEA ROUSSEAU SURVEY, ABSTRACT NUMBER 56, SITUATED IN BASTROP COUNTY, TEXAS, DOES HEREBY SUBDIVIDE 1.758 ACRES OF LAND, IN ACCORDANCE WITH THE ATTACHED MAP OR PLAT, TO BE KNOWN AS:

"THE FINAL PLAT OF PECAN PARK, SECTION 3F"

AND DOES HEREBY DEDICATE TO THE PUBLIC, THE USE OF THE EASEMENTS SHOWN HEREON, SUBJECT TO ANY EASEMENTS AND/OR RESTRICTIONS HERETOFORE GRANTED AND NOT RELEASED.

WITNESS MY HAND, THIS THE ____ DAY OF _____, 20____, A.D.

RANCH ROAD DEVELOPMENT, LLC.
3140 DYER STREET, SUITE 624
DALLAS, TEXAS 75275

STATE OF TEXAS §
COUNTY OF BASTROP § KNOW ALL MEN BY THESE PRESENTS:

BEFORE ME, THE UNDERSIGNED AUTHORITY, ON THIS DAY PERSONALLY APPEARED _____, KNOWN TO ME TO BE THE PERSON WHOSE NAME IS SUBSCRIBED TO THE FOREGOING INSTRUMENT OF WRITING, AND HE ACKNOWLEDGED TO ME THAT HE EXECUTED THE SAME FOR THE PURPOSES AND CONSIDERATIONS THEREIN EXPRESSED AND IN THE CAPACITY THEREIN STATED.

WITNESS MY HAND AND SEAL OF OFFICE, THIS THE ____ DAY OF _____, 20____, A.D.

NOTARY PUBLIC IN AND FOR THE STATE OF TEXAS

STATE OF TEXAS §
COUNTY OF BASTROP § KNOW ALL MEN BY THESE PRESENTS:

I, ROSE PIETSCH, CLERK OF BASTROP COUNTY, DO HEREBY CERTIFY THAT THE FOREGOING INSTRUMENT OF WRITING AND ITS CERTIFICATE OF AUTHENTICATION WAS FILED FOR RECORD IN MY OFFICE ON THE ____ DAY OF _____, 20____, A.D., IN THE PLAT RECORDS OF SAID COUNTY AND STATE IN PLAT CABINET _____, PAGE(S) _____, FILED FOR RECORD AT _____ O'CLOCK ____M., THIS ____ DAY OF _____, 20____, A.D.,

WITNESS MY HAND AND SEAL OF OFFICE OF THE COUNTY CLERK, THE ____ DAY OF _____, 20____, A.D.

COUNTY CLERK, BASTROP COUNTY, TEXAS

BY: DEPUTY

APPROVED AND ACCEPTED THIS
THE ____ DAY OF _____, 20____, BY THE CITY COUNCIL OF THE CITY OF BASTROP, TEXAS.

APPROVED AND ACCEPTED:

CONNIE SCHROEDER,
MAYOR OF THE CITY OF BASTROP, TEXAS

ATTEST:

CITY SECRETARY, CITY OF BASTROP, TEXAS

STATE OF TEXAS))
COUNTY OF TRAVIS)) KNOW ALL MEN BY THESE PRESENTS:

I, CHARLES R. BRIGANCE, JR., P.E. DO HEREBY CERTIFY THAT THE STREETS AND DRAINAGE DESIGN, AS SHOWN HEREON, COMPLIES WITH THE SUBDIVISION REGULATIONS FOR THE CITY OF BASTROP, AND THAT THE 100 YEAR FLOOD PLAN IS AS SHOWN AND WILL BE CONTAINED WITHIN THE DRAINAGE EASEMENT AND OR DRAINAGE RIGHT-OF-WAY, AS SHOWN HEREON.

ENGINEERING BY: _____ DATE _____
CHARLES R. BRIGANCE, JR., P.E. NO. 64346
CARLSON, BRIGANCE & DOERING, INC.
5501 WEST WILLIAM CANNON DRIVE
AUSTIN, TEXAS 78749

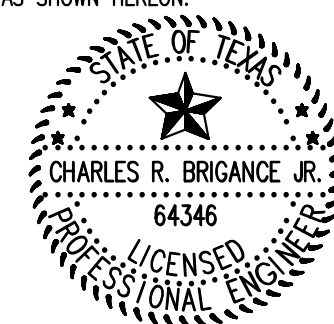

STATE OF TEXAS))
COUNTY OF TRAVIS)) KNOW ALL MEN BY THESE PRESENTS:

THAT I, AARON V. THOMASON, DO HEREBY CERTIFY THAT I PREPARED THIS PLAT FROM AN ACTUAL AND ACCURATE ON-THE-GROUND SURVEY OF THE LAND AND THAT THE CORNER MONUMENTS SHOWN THEREON WERE PROPERLY PLACED UNDER MY PERSONAL SUPERVISION, IN ACCORDANCE WITH THE SUBDIVISION REGULATION OF THE CITY OF BASTROP, BASTROP COUNTY, TEXAS. ALL EASEMENTS OF RECORD HAVE BEEN IDENTIFIED ON THIS PLAT TO THE BEST OF MY KNOWLEDGE.

SURVEYED BY: _____ DATE _____
AARON V. THOMASON - R.P.L.S. NO. 6214
CARLSON, BRIGANCE & DOERING, INC.
5501 WEST WILLIAM CANNON DRIVE
AUSTIN, TEXAS 78749

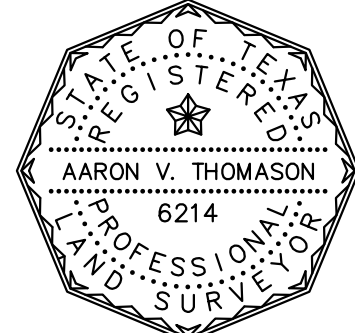

- NOTES:**
- WATER SERVICE IS PROVIDED BY THE CITY OF BASTROP.
 - WASTEWATER SERVICE IS PROVIDED BY THE CITY OF BASTROP.
 - ELECTRIC SERVICE IS PROVIDED BY THE BLUEBONNET ELECTRIC.
 - ALL EASEMENTS OF RECORD AS INDICATED ON THE MOST RECENT TITLE RUN DATED: SEPTEMBER 6, 2017, CONDUCTED BY CHICAGO TITLE INSURANCE COMPANY, TITLE COMMITMENT GF. NO. 1736054-BCP ISSUED BY CHICAGO TITLE INSURANCE COMPANY FOR THIS PROPERTY ARE SHOWN ON THIS PLAT.
 - ALL SUBDIVISION PERMITS SHALL CONFORM TO THE CITY OF BASTROP CODE OF ORDINANCES, CONSTRUCTION STANDARDS, AND GENERALLY ACCEPTED ENGINEERING PRACTICES.
 - CONSTRUCTION PLANS AND SPECIFICATIONS FOR ALL SUBDIVISION IMPROVEMENTS SHALL BE REVIEWED AND ACCEPTED BY THE CITY OF BASTROP PRIOR TO ANY CONSTRUCTION WITHIN THE SUBDIVISION.
 - THE OWNER OF THIS SUBDIVISION, AND HIS OR HER SUCCESSORS AND ASSIGNS, ASSUMES SOLE RESPONSIBILITY FOR PLANS FOR CONSTRUCTION OF SUBDIVISION IMPROVEMENTS WHICH COMPLY WITH APPLICABLE CODES AND REQUIREMENTS OF THE CITY OF BASTROP. THE OWNER UNDERSTANDS AND ACKNOWLEDGES THAT PLAT VACATION OR RE-PLATTING MAY BE REQUIRED, AT THE OWNER'S SOLE EXPENSE, IF PLANS TO CONSTRUCT THIS SUBDIVISION DO NOT COMPLY WITH SUCH CODES AND REQUIREMENTS.
 - BY APPROVING THIS PLAT, THE CITY OF BASTROP ASSUMES NO OBLIGATION TO CONSTRUCT ANY INFRASTRUCTURE IN CONNECTION WITH THIS SUBDIVISION. ANY SUBDIVISION INFRASTRUCTURE REQUIRED FOR THE DEVELOPMENT OF THE LOTS IN THIS SUBDIVISION IS THE SOLE RESPONSIBILITY OF THE DEVELOPER AND/OR THE OWNERS OF THE LOTS. FAILURE TO CONSTRUCT ANY REQUIRED INFRASTRUCTURE TO CITY STANDARDS MAY BE JUST CAUSE FOR THE CITY TO DENY APPLICATIONS FOR CERTAIN DEVELOPMENT PERMITS INCLUDING BUILDING PERMITS, SITE PLAN APPROVALS AND/OR CERTIFICATES OF OCCUPANCY.
 - FISCAL SURETY FOR SUBDIVISION CONSTRUCTION, IN A FORM ACCEPTABLE TO THE CITY OF BASTROP, SHALL BE PROVIDED PRIOR TO PLAT APPROVAL BY THE CITY.
 - NO LOT IN THIS SUBDIVISION SHALL BE OCCUPIED UNTIL CONNECTED TO THE APPROVED WATER DISTRIBUTION AND WASTEWATER COLLECTION FACILITIES.
 - WASTEWATER AND WATER SYSTEMS SHALL CONFORM TO TEXAS COMMISSION ON ENVIRONMENTAL QUALITY (TCEQ).
 - ALL UTILITIES WILL BE UNDERGROUND.
 - IMPACT FEES SHALL BE ASSESSED IN ACCORDANCE WITH THE ORDINANCE #2017-13.
 - DEVELOPER SHALL BE SOLELY RESPONSIBLE FOR ALL RELOCATION AND MODIFICATIONS TO EXISTING UTILITIES.
 - NO PORTION OF THIS TRACT LIES WITHIN A DESIGNATED FLOOD HAZARD AREA, THIS TRACT LIES IN ZONE X, AS SHOWN ON THE FEDERAL FLOOD INSURANCE ADMINISTRATION RATE MAP NO. 48021 C 0355E, FOR BASTROP COUNTY TEXAS, DATED JANUARY 19, 2006. COMMUNITY NUMBER 481193.
 - ON-SITE STORM WATER DETENTION FACILITIES WILL BE PROVIDED TO REDUCE POST-DEVELOPMENT PEAK RATES OF DISCHARGE OF THE 5, 10, 25, 50 AND 100-YEAR STORM EVENTS.
 - TEMPORARY AND PERMANENT EASEMENTS TO BE PROVIDED, AS REQUIRED AT THE CITY'S SOLE DISCRETION FOR OFF-SITE WATER, WASTEWATER AND DRAINAGE IMPROVEMENTS.
 - AS SHOWN HEREON, A TEN (10) FOOT WIDE PUBLIC UTILITY EASEMENT (P.U.E.) IS HEREBY DEDICATED ADJACENT TO STREET RIGHTS-OF-WAY ON ALL LOTS. A FIVE (5) FOOT WIDE P.U.E. IS HEREBY DEDICATED ALONG EACH SIDE AND REAR LOT LINE.
 - PROPERTY OWNER SHALL PROVIDE FOR ACCESS TO ALL EASEMENTS AS MAY BE NECESSARY AND SHALL NOT PROHIBIT ACCESS BY GOVERNMENTAL AUTHORITIES.
 - NO BUILDINGS, FENCES, LANDSCAPING OR OTHER STRUCTURES ARE PERMITTED WITHIN DRAINAGE EASEMENTS SHOWN, EXCEPT AS APPROVED BY THE CITY OF BASTROP AND/OR BASTROP COUNTY.
 - ALL EASEMENTS ON PRIVATE PROPERTY SHALL BE MAINTAINED BY THE PROPERTY OWNER OR HIS OR HER ASSIGNEES.
 - NO LOT OR STRUCTURE SHALL BE OCCUPIED PRIOR TO THE APPLICANT SUBMITTING TO THE CITY OF BASTROP DOCUMENTATION OF SUBDIVISION/SITE REGISTRATION WITH THE TEXAS DEPARTMENT OF LICENSING AND REGULATIONS (TDLR) AND PROVIDE DOCUMENTATION OF REVIEW AND COMPLIANCE OF THE SUBDIVISION CONSTRUCTION PLANS WITH TEXAS ARCHITECTURAL BARRIERS ACT (TABA).
 - EROSION AND SEDIMENTATION CONTROLS CONSTRUCTED IN ACCORDANCE WITH THE SUBDIVISION ORDINANCE OF THE CITY OF BASTROP ARE REQUIRED FOR ALL CONSTRUCTION ON EACH LOT, INCLUDING SINGLE FAMILY AND DUPLEX CONSTRUCTION.
 - IT IS THE RESPONSIBILITY OF EACH BUILDER TO DESIGN AND CONSTRUCT A SUITABLE GRADING AND DRAINAGE SCHEME WHICH WILL CONVEY SURFACE WATER, WITHOUT PONDING IN THE LOT OR UNDER THE STRUCTURE, FROM HIS STRUCTURE TO THE DRAINAGE SYSTEM CONSTRUCTED BY THE SUBDIVISION DEVELOPER.
 - PUBLIC UTILITY AND DRAINAGE EASEMENTS WHERE SHOWN AND/OR DESCRIBED HEREON ARE INTENDED TO INDICATE AN EASEMENT FOR CONSTRUCTION, OPERATION, AND MAINTENANCE OF PUBLIC UTILITIES AND DRAINAGE WAYS; INCLUDING, BUT NOT LIMITED TO, SANITARY SEWERS, FORCE MAINS, WATER LINES, TELEPHONE SIGNAL CONDUITS, ELECTRIC CONDUCTORS, DRAINAGE PIPES, AND NATURAL GAS LINES.
 - SIDEWALKS SHALL BE CONSTRUCTED IN ACCORDANCE WITH THE SUBDIVISION ORDINANCE OF THE CITY OF BASTROP.
 - PRIOR TO CONSTRUCTION OF ANY IMPROVEMENTS ON LOTS IN THIS SUBDIVISION, BUILDING PERMITS WILL BE OBTAINED FROM THE CITY OF BASTROP.
 - BUILDING SETBACKS NOT SHOWN SHALL BE IN ACCORDANCE WITH CITY OF BASTROP ZONING ORDINANCE 2017-14.
 - A CITY OF BASTROP BUILDING PERMIT IS REQUIRED PRIOR TO ANY SITE DEVELOPMENT.
 - THE ELECTRIC UTILITY HAS THE RIGHT TO PRUNE AND/OR REMOVE TREES, SHRUBBERY VEGETATION AND OTHER OBSTRUCTIONS TO THE EXTENT NECESSARY TO KEEP THE EASEMENTS CLEAR. THE OWNER/DEVELOPER OF THIS SUBDIVISION/LOT SHALL PROVIDE THE CITY OF BASTROP ELECTRIC UTILITY DEPARTMENT WITH ANY EASEMENT AND/OR ACCESS REQUIRED, IN ADDITION TO THOSE INDICATED, FOR THE INSTALLATION AND ONGOING MAINTENANCE OF OVERHEAD AND UNDERGROUND ELECTRIC FACILITIES.
 - THE OWNER SHALL BE RESPONSIBLE FOR INSTALLATION OF TEMPORARY EROSION CONTROL, RE-VEGETATION AND TREE PROTECTION FOR ELECTRIC UTILITY WORK REQUIRED TO PROVIDE ELECTRIC SERVICE TO THIS PROJECT.
 - THIS PROJECT IS GOVERNED BY THE MEMORANDUM OF UNDERSTANDING DATED 12-12-2013; ZONING ORDINANCE 2015-15; AMENDED ZONING ORDINANCE 2017-14; AND IS SUBJECT TO THE PECAN PARK TRAFFIC IMPACT ANALYSIS DATED 9-22-2015 PREPARED BY ALLIANCE TRANSPORTATION GROUP.
 - THIS PLAT IS SUBJECT TO THE CITY OF BASTROP ORDINANCE 2015-15 & 2017-14 & IS IN DISTRICT PD-SFS.

FLOOD PLAN NOTE:

NO PORTION OF THIS TRACT LIES WITHIN THE DESIGNATED FLOOD HAZARD AREA, THIS TRACT LIES IN ZONE X, AS SHOWN ON THE FEDERAL FLOOD INSURANCE ADMINISTRATION RATE MAP NO. 48021 C 0355E, FOR BASTROP COUNTY TEXAS, DATED JANUARY 19, 2006. COMMUNITY CASE NUMBER 481193, AS MODIFIED BY CLOMR CASE # 06-06-B025R, DATED JULY 31, 2006.

BENCHMARK INFORMATION:

BM #1: COTTON SPINDLE SET IN THE SOUTHWEST EDGE OF PAVEMENT OF TRAILSIDE LANE, +/- 160' SOUTHWEST OF INTERSECTION OF DEERFOOT TRAIL. ELEVATION (NAVD88) = 358.31'

FIELD NOTES

BEING ALL THAT CERTAIN 1.758 ACRE TRACT OR PARCEL OF LAND OUT OF AND A PART OF THE MOZEA ROUSSEAU SURVEY, ABSTRACT NUMBER 56, SITUATED IN BASTROP COUNTY, TEXAS, SAID TRACT OF LAND BEING MORE PARTICULARLY DESCRIBED AS A PORTION OF THAT CERTAIN 174.334 ACRE TRACT OF LAND, CONVEYED TO RANCH ROAD DEVELOPMENT, LLC, IN DOCUMENT NUMBER 201717048, OFFICIAL PUBLIC RECORDS, BASTROP COUNTY, TEXAS, SAID 1.758 ACRE TRACT OF LAND BEING MORE FULLY DESCRIBED BY METES AND BOUNDS AS FOLLOWS:

BEGINNING, at a 1/2 inch iron rod found at the southernmost corner of Common Area 2, Pecan Park Residential Section 3A, recorded in Cabinet 6, Side 62-A, Plat Records, Bastrop County, Texas, being at the northwestern terminus of Trailside Lane (50' R.O.W.), for the northernmost corner and the POINT OF BEGINNING of the herein described tract,

THENCE, S35°08'15"E, with a southwest line of said Pecan Park Residential Section 3A, passing at a distance of 50.00 feet a 1/2 inch iron rod found at the southern terminus of said Trailside Lane and the westernmost corner of Lot 35 of said Pecan Park Residential Section 3A, and continuing for a total distance of 174.10 feet to a 1/2 inch iron rod found at the southernmost corner of said Lot 35,

THENCE, over and across said 174.334 acre tract of land, the following seven (7) courses and distances, numbered 1 through 7,

- S30°54'42"E, a distance of 14.99 feet to a 1/2 inch iron rod set with cap stamped "Setstone" for the easternmost corner of the herein described tract of land,
- S44°31'50"W, a distance of 59.96 feet to a 1/2 inch iron rod set with cap stamped "Setstone" for corner,
- S20°08'34"W, a distance of 169.99 feet to a 1/2 inch iron rod set with cap stamped "Setstone" for corner,
- S16°07'43"W, a distance of 150.37 feet to a 1/2 inch iron rod set with cap stamped "Setstone" for the southernmost corner of the herein described tract of land,
- N69°51'48"W, a distance of 130.58 feet to a 1/2 inch iron rod set with cap stamped "Setstone" for corner,
- S20°08'29"W, a distance of 3.86 feet to a 1 1/2 inch iron rod set with cap stamped "Setstone" for corner,
- N69°51'31"W, a distance of 50.00 feet to a 1/2 inch iron rod set with cap stamped "Setstone" for the westernmost corner of the herein described tract of land,
- N20°08'29"E, a distance of 358.90 feet to a 1/2 inch iron rod set with cap stamped "Setstone" for corner at the beginning of a curve to the right,
- Along said curve to the right, having a radius of 225.00 feet, an arc length of 136.35 feet, and a chord that bears N37°30'07"E, a distance of 134.27 feet to the POINT OF BEGINNING and containing 1.758 acres of land.

BLOCK	LOT	SQ. FT.
B	36	5,167
B	37	5,055
B	38	4,943
B	39	4,834
B	40	4,802
B	41	4,802
B	42	4,802
B	43	4,802
B	44	5,449
B	45	7,906

SHEET NO. 2 OF 2



Carlson, Brigance & Doering, Inc.
FIRM ID #13791 ♦ REG. # 10024900

Civil Engineering	Surveying
5501 West William Cannon	♦ Austin, Texas 78749
Phone No. (512) 280-5160	♦ Fax No. (512) 280-5165

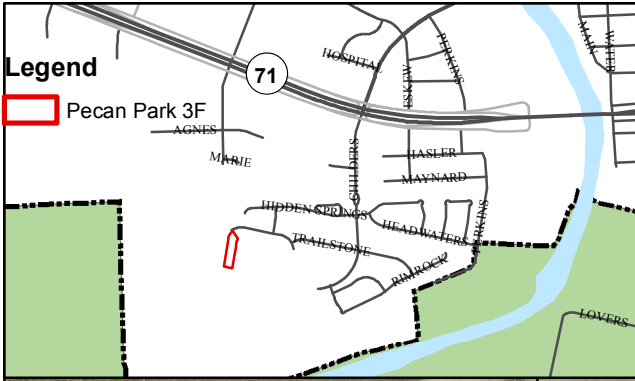

Location Map
Final Plat of
Pecan Park Section 3F



1 inch = 270 feet



The accuracy and precision of this cartographic data is limited and should be used for information /planning purposes only. This data does not replace surveys conducted by registered Texas land surveyors nor does it constitute an "official" verification of zoning, land use classification, or other classification set forth in local, state, or federal regulatory processes. The City of Bastrop, nor any of its employees, do not make any warranty of merchantability and fitness for particular purpose, or assumes any legal liability or responsibility for the accuracy, completeness or usefulness of any such information, nor does it represent that its use would not infringe upon privately owned rights.

Date: 10/30/2018

**Notice of Pending Final Plat Approval
City of Bastrop
City Council**



Dear Property Owner:

The **City Council** will conduct a public meeting **Tuesday, November 27, 2018 at 6:30 p.m.** in the **City Hall Council Chambers located at 1311 Chestnut Street, Bastrop, Texas** to consider the approval of a final plat for Pecan Park Section 3F being 1.758 acres out of the Mozea Rousseau Survey, Abstract 56, located on the extension of Trailside Lane within the city limits of Bastrop, Texas.

Applicant/Owner: Ranch Road Development LLC

Location/Address: Extension of Trailside Lane

Legal Description: Mozea Rousseau Survey, Abstract No. 56, being 1.758 acres

Number of Lots: 10 residential lots

The site location map and a copy of the plat is attached for reference.

As a property owner within 200 feet of the above referenced property, you are being notified of the upcoming meetings per the Bastrop Code of Ordinances. For more information on this project, you can contact the Planning & Development offices at (512) 332-8840, plan@cityofbastrop.org, or visit the office at 1311 Chestnut Street, Bastrop, Texas.

For additional information, please visit or call the Planning & Development offices.

Please provide reply to the address below, via fax (512) 332-8829, or email: plan@cityofbastrop.org

[For: Final Plat Pecan Park Section 3F](#)



STAFF REPORT

MEETING DATE: November 13, 2018

AGENDA ITEM: 8D

TITLE:

Consider action to approve Resolution No. R-2018-112 of the City Council of the City of Bastrop, Texas abandoning a ten-foot (10') easement, forty feet (40') in length, located within a one-hundred and ninety foot (190') Public Utility Easement (PUE) located along the northern property line of Lot 2, Chestnut Square Subdivision, being located in Bastrop, Texas, as shown in Exhibit "A"; providing for a repealing clause; and establishing an effective date.

STAFF REPRESENTATIVE:

Matt Jones, Planning and Development Director

BACKGROUND/HISTORY:

A Final Plat of Chestnut Square was approved by the City of Bastrop on February 27, 2001. As a part of this Final Plat, a 190' Public Utility Easement (PUE) was dedicated along a portion of the northern lot line of Lot 2. The existing building, which is located on Lot 2, being located at 1100 Highway 95 prior to the filing of the PUE, encroaches into the 190' PUE, based on how the easement was platted. There are no utilities located in the eastern 40' of the PUE.

The current property owner brought this matter to the City's attention. Therefore, the City has initiated a partial easement abandonment to resolve the encroachment of the existing building into the PUE.

POLICY EXPLANATION:

This resolution, if passed, will provide for the health, safety, and general welfare of the City and will resolve the encroachment of an existing building into a Public Utility Easement.

FUNDING SOURCE:

N/A

RECOMMENDATION:

Consider action to approve Resolution No. R-2018-112 of the City Council of the City of Bastrop, Texas abandoning a ten-foot (10') easement, forty feet (40') in length, located within a one-hundred and ninety foot (190') Public Utility Easement (PUE) located along the northern property line of Lot 2, Chestnut Square Subdivision, being located in Bastrop, Texas, as shown in Exhibit "A"; providing for a repealing clause; and establishing an effective date.

ATTACHMENTS:

- Resolution
- Exhibit "A"

RESOLUTION NO. R-2018-112

A RESOLUTION OF THE CITY COUNCIL OF THE CITY OF BASTROP, TEXAS ABANDONING A TEN-FOOT (10') EASEMENT, FORTY FEET (40') IN LENGTH, LOCATED WITHIN A ONE-HUNDRED AND NINETY FOOT (190') PUBLIC UTILITY EASEMENT (PUE) LOCATED ALONG THE NORTHERN PROPERTY LINE OF LOT 2, CHESTNUT SQUARE SUBDIVISION, BEING LOCATED IN BASTROP, TEXAS, AS SHOWN IN EXHIBIT "A"; PROVIDING FOR A REPEALING CLAUSE; AND ESTABLISHING AN EFFECTIVE DATE.

WHEREAS, The City Council recognizes the responsibility to promote the health, safety, and general welfare of the City, and to enact appropriate development standards; and

WHEREAS, there are currently no utilities located within the forty-foot portion of the Public Utility Easement to be abandoned; and

WHEREAS, the abandonment of the portion of the Public Utility Easement would resolve the encroachment of an existing building into the Public Utility Easement; and

NOW, THEREFORE, BE IT RESOLVED BY THE CITY COUNCIL OF THE CITY OF BASTROP, TEXAS:

SECTION 1: Abandoning a ten-foot (10') easement, forty feet (40') in length, located within a one-hundred and ninety foot (190') Public Utility Easement (PUE) located along the northern property line of Lot 2, Chestnut Square Subdivision

SECTION 2: All orders, ordinances, and resolutions, or parts thereof, which are in conflict or inconsistent with any provision of this Resolution are hereby repealed to the extent of such conflict, and the provisions of this Resolution shall be and remain controlling as to the matters resolved herein.

SECTION 3: That this resolution shall take effect immediately from and after its passage, and it is duly resolved.

DULY RESOLVED AND APPROVED by the City Council of the City of Bastrop this 13th day of November 2018.

APPROVED:

Connie B. Schroeder, Mayor

ATTEST:

Ann Franklin, City Secretary

APPROVED AS TO FORM:

Alan Bojorquez, City Attorney

EXHIBIT "A"

CHESTNUT SQUARE

FARM STREET (55.55' ROW)

STATE HIGHWAY 95 (100' ROW)

FINAL PLAT NUMBER OF LOTS - 3 JUNE 17, 1987 TOTAL ACRES 7.5355

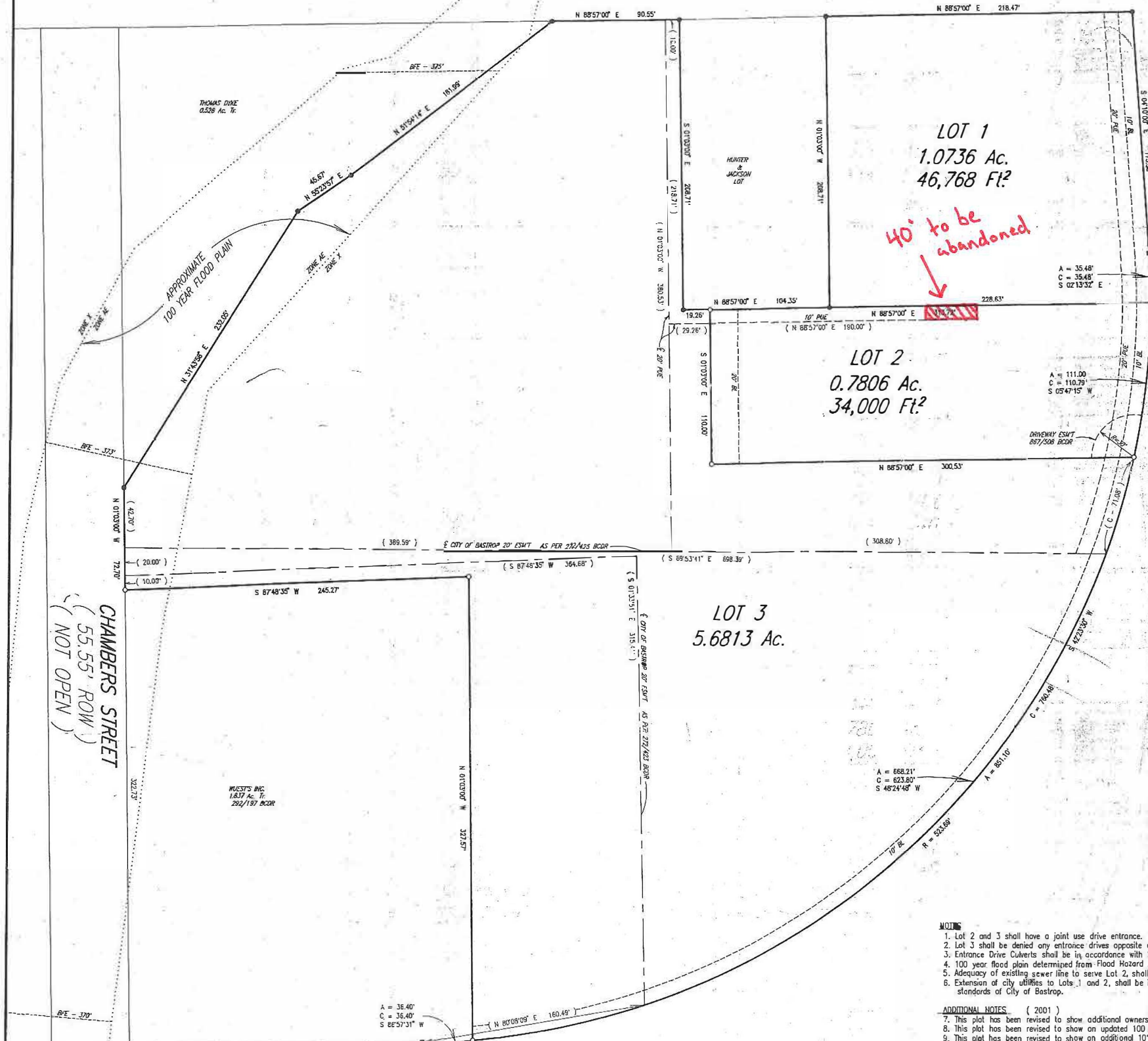

40' to be abandoned

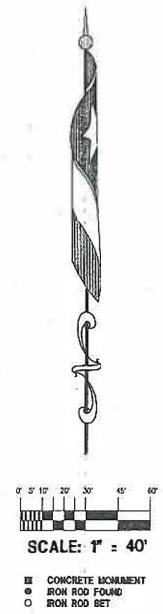

STATE OF TEXAS COUNTY OF BASTROP KNOW ALL MEN BY THESE PRESENTS: That Thomas A. Dyke, Tr. (Lots 1 & 3) and Jeffrey R. Voigt and wife, Cheree L. Voigt (Lot 2), owners of 7.5355 acres of land in Building Blocks 71, 72, 89 & 90, East of Main Street, in the City of Bastrop, Bastrop County, Texas, and being a part of that property described in deeds recorded in Vol. 278, Pg. 436, and Vol. 272, Pg. 420 (Lots 1 & 3), and all of that property described in Vol. 867, Pg. 512 (Lot 2), Bastrop County Deed Records, have caused said acreage to be surveyed and plotted as shown on the foregoing map to be known as CHESTNUT SQUARE, and do hereby dedicate to the Public the use of the Streets and Easements as show hereon.

Witness my hand this the 28th day of February, 2001, A.D. Thomas A. Dyke

STATE OF TEXAS COUNTY OF BASTROP This instrument was acknowledged before me on the 28th day of February, 2001, by Thomas A. Dyke.

STATE OF TEXAS COUNTY OF BASTROP This instrument was acknowledged before me on the 28th day of February, 2001, by Jeffrey R. Voigt.

STATE OF TEXAS COUNTY OF BASTROP This instrument was acknowledged before me on the 28th day of February, 2001, by Cheree L. Voigt.

STATE OF TEXAS COUNTY OF BASTROP I, Dale L. Olson, do hereby certify that I prepared this REDRAWN plot from an actual and accurate on-the-ground survey performed in 1987, of the land, and that the corner monuments shown were properly placed under my personal supervision, at that time, in accordance with the Subdivision Regulations of the City of Bastrop, Bastrop County, Texas.

Dale L. Olson, Registered Public Surveyor, Reg. No. 1753, 711 Water Street, Bastrop, Texas 78602 (512) 321-5476

Approved on this 27th day of Feb., 2001, A.D., by the City Council of the City of Bastrop.

APPROVED: Tom Scott, Mayor of the City of Bastrop, Texas. ATTEST: Jason Mistach, City Secretary, City of Bastrop, Texas.

STATE OF TEXAS COUNTY OF BASTROP I, Shirley Wilhelm, Clerk of Bastrop County do hereby certify that the foregoing instrument of writing and the certificate of authentication was filed for record in my office on this 15th day of March, 2001, A.D. in the Plot Records of said County and State in Plot Cabinet 4 Page(s) 27-A.

Filed for Record at 12:15 o'clock A.M. this the 15th day of March, 2001, A.D. Witness my hand and seal of the office of County Clerk of said County on this the 15th day of March, 2001, A.D.

Shirley Wilhelm, County Clerk, Bastrop County, Texas

- NOTES: 1. Lot 2 and 3 shall have a joint use drive entrance. 2. Lot 3 shall be denied any entrance drives opposite existing Highway Dept. Islands. 3. Entrance Drive Culverts shall be in accordance with State Hwy. Dept regulations. 4. 100 year flood plain determined from Flood Hazard Boundary Map FRM No. 48021C 0118 C. (REVISED 2001) 5. Adequacy of existing sewer line to serve Lot 2, shall be subject to the City's approval. 6. Extension of city utilities to Lots 1 and 2, shall be in accordance with construction standards of City of Bastrop. 7. This plot has been revised to show additional ownership for Lot 2. 8. This plot has been revised to show an updated 100 year flood plain. 9. This plot has been revised to show an additional 10' PUE along a portion of the north line of Lot 2. 10. This plot has been revised to reflect the current City of Bastrop Mayor and City Secretary. 11. This plot has been revised to show Drive Easement, as per Vol. 867, Pg. 508, BCDR. (Previous Note No. 2) 12. The original fieldwork performed and plotted in 1987, REDRAWN Feb. 2001.

BENCH MARK - 372.61' TOP OF CONCRETE MONUMENT FOUND 1 FOOT WEST OF NORTHWEST CORNER OF CHESTNUT STREET BRIDGE AT GLENN BRANCH (RA B - AS SHOWN ON PDU)



STAFF REPORT

MEETING DATE: November 13, 2018

AGENDA ITEM: 9A

TITLE:

Consider action and approve Resolution No. R-2018-113 of the City Council of the City of Bastrop, Texas, making determinations regarding certain project-specific Exceptions and/or Exemptions as provided by Emergency Ordinance 2018-1, Section 8 (Temporary Moratorium); and Emergency Ordinance 2018-2, Section 7 (Emergency Drainage Application Rules).

STAFF REPRESENTATIVE:

Jennifer Bills, Assistant Planning Director

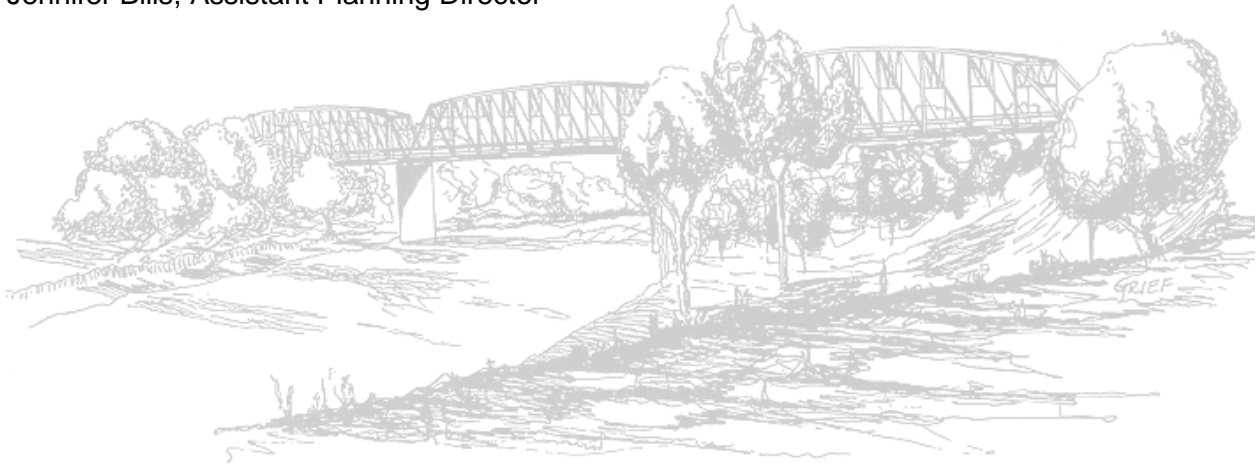



STAFF REPORT

MEETING DATE: November 13, 2018

AGENDA ITEM: 9B

TITLE:

Hold public hearing and consider action to approve the first reading of Emergency Ordinance No. 2018-1-A of the City Council of the City of Bastrop, Texas, extending the temporary moratorium, Emergency Ordinance No. 2018-1, enacted August 23, 2018; including a severability clause; establishing an effective date and motion to include on the November 15, 2018 Special Meeting Agenda.

STAFF REPRESENTATIVE:

Lynda K. Humble, City Manager
Alan Bojorquez, City Attorney

BACKGROUND/HISTORY:

City Council passed Emergency Ordinance No. 2018-1, which established a Temporary Moratorium commencing on August 23, 2018, and created a short-term freeze on the acceptance of applications for subdivision, building permits, or development permits for the purpose of preserving the status quo in order to allow the Council reasonable time to review, conduct research, receive public input, evaluate and establish reasonable policies, and prepare a comprehensive subdivision ordinance for future adoption.

City Council also passed Emergency Ordinance No. 2018-2-A, which established additional requirements mandating data related to drainage and flooding for the acceptance, processing, and approval of certain projects in the city limits and the extraterritorial jurisdiction during the moratorium. The additional requirements mandated by Emergency Ordinance No. 2018-2-A have given the City the ability to assess the impact of these projects on potential future flooding events.

As a part of these two (2) ordinances, the City Council adopted a temporary process that allows development to continue in the City of Bastrop requiring projects to be evaluated on a case-by-case basis through pre-application meetings and conformity to specific interim drainage measures to ensure that detrimental development does not occur. The temporary process is considered a successful interim solution as of October 31, 2018 having held 41 individual pre-application meetings, issued 212 permits since the inception of the moratorium including 17 new single-family residential, five (5) commercial remodels, one (1) new office complex, and two (2) commercial finish-out permits, and prevented one (1) house from being built in a drainage area.

The City has retained a planning consultant firm for the purpose of evaluating the City's historic, current and anticipated construction attributes, and is developing new standards to preserve the quality of life and to protect the health, safety, and general welfare of the citizens of the City and to direct and manage the rapid growth that is now occurring. The City's planning consulting firm has completed both an in-depth analysis of Downtown Bastrop's DNA and how it functions as a complete neighborhood and an extensive evaluation of the City's current development codes that

identified significant challenges and code conflicts that are not aligned with the City's Comprehensive Plan 2036 or considered fiscally sustainable or geographically sensitive.

It is important to complete and adopt new development standards including establishing appropriate drainage regulations with impervious cover limitations, appropriate zoning districts and district regulations, appropriate cut and fill regulations, and address identified issues that will affect future growth and development of the area within its jurisdiction. The adoption process of new development standards will require community input and will take additional amount of time to complete. Without the additional requirements mandated by Emergency Ordinance No. 2018-2, the City's review process for drainage and stormwater improvements throughout the City Limits and Extraterritorial Jurisdiction would revert to being inadequate and insufficient to prevent, mitigate, or minimize future flooding events.

POLICY EXPLANATION:

Emergency Ordinance No. 2018-1, which established a temporary moratorium for ninety (90) days, is set to expire on November 22, 2019. The attached Ordinance will extend the existing temporary moratorium by an additional six (6) months expiring on May 21, 2019.

Council has been extremely committed to ensuring that impending and future development is conducted in a fiscally sustainable and environmentally responsible manner that honors the City's rich heritage and unique ecological makeup. This extension of the moratorium is necessary to provide the City with the time to continue to properly conduct research, confer with experts, and solicit public input from residents, business owners, property owners, realtors and developers to ensure this goal is achieved.

FUNDING SOURCE:

N/A

RECOMMENDATION:

Hold public hearing and consider action to approve the first reading of Emergency Ordinance No. 2018-1-A of the City Council of the City of Bastrop, Texas, extending the temporary moratorium, Emergency Ordinance No. 2018-1, enacted August 23, 2018; including a severability clause; establishing an effective date and motion to include on the November 15, 2018 Special Meeting Agenda.

ATTACHMENT:

- Emergency Ordinance 2018-1-A

CITY OF BASTROP, TX

EMERGENCY ORDINANCE NO. 2018-1-A

AN ORDINANCE OF THE CITY OF BASTROP, TEXAS, EXTENDING EMERGENCY ORDINANCE NO. 2018-1, THE TEMPORARY MORATORIUM STAYING THE ACCEPTANCE AND PROCESSING OF CERTAIN PERMITS IN THE BASTROP CITY LIMITS AND EXTRATERRITORIAL JURISDICTION, PROVIDING FOR FINDINGS OF FACT, DEFINITIONS, APPLICABILITY, PURPOSE, ENACTMENT, DURATION, EXTENSION, EXCEPTIONS AND EXEMPTIONS, DETERMINATION AND APPEALS, REPEALER, SEVERABILITY, ENFORCEMENT, EFFECTIVE DATE, AND PROPER NOTICE AND MEETING.

WHEREAS, the City of Bastrop, Texas ("City") is a Home-Rule City acting under its Charter adopted by the electorate pursuant to Article XI, Section 5, of the Texas Constitution, and Chapter 9 of the Texas Local Government Code; and

WHEREAS, the Bastrop City Council ("City Council"), as a duly-elected legislative body, finds that it is facing significant historic and contemporary land use challenges that existing regulations were not designed to address; and

WHEREAS, the City Council finds that the City has been actively and diligently engaged in its assessment of the City's drainage and regulatory program, including evaluating its subdivision ordinance, zoning codes, and the uniformity of its permitting process and goals for stormwater plans and improvements; and

WHEREAS, Texas Local Government Code Section 51.001 provides the City general authority to adopt an Ordinance or police regulations that are for the good government, peace or order of the City and is necessary or proper for carrying out a power granted by law to the City; and

WHEREAS, Texas Local Government Code Chapters 211, 213, 214 and 217 grant the City certain regulation authority concerning construction, land use, nuisances, structures, and development-related activities; and

WHEREAS, the City seeks to ensure that impending and future development is conducted in a fiscally sustainable and environmentally responsible manner that honors the City's rich heritage and unique ecological makeup; and

WHEREAS, the City will change drastically if unlimited growth and development should occur under the City's existing Code of Ordinances, which no longer adequately address concerns about the effect of development on the City; and

WHEREAS, the City has experienced historical flooding events over the decades and four (4) FEMA-declared disasters in the past three (3) years; and

WHEREAS, the City's current development standards and regulations are based on 1983 and 1991 data that is outdated and used a one size fits all approach; and

WHEREAS, the City Limits and Extraterritorial Jurisdiction (“ETJ”) are comprised of a combination of ecological and topographical features that create significant drainage and development challenges when using the one size fits all approach; and

WHEREAS, in 2016, the City commissioned engineering firm Halff and Associates to study the City’s drainage issues; and

WHEREAS, in 2018, Halff and Associates provided the City with Flood Protection Planning Studies for two (2) watersheds in the Bastrop area: Piney Creek and Gills Branch; and

WHEREAS, on July 28, 2018, the City Council, accompanied by the Planning and Zoning Commission, participated in a properly posted, public bus tour of key locales around the community, including sites of significant development-related drainage challenges; and

WHEREAS, the Gills Branch and Piney Creek Studies document the needs and challenges of the existing drainage and flood mitigation infrastructure across the City Limits and ETJ; and

WHEREAS, the City and Bastrop County have been diligently evaluating and assessing the findings in the 2018 Gills Branch and Piney Creek Studies; and

WHEREAS, the City held a work session on February 20, 2018 to review the findings of the Gills Branch and Piney Creek Studies with the public; and

WHEREAS, the City Council finds that certain essential public and private infrastructure, being drainage and storm water improvements throughout the City Limits and ETJ, are inadequate and insufficient to prevent, mitigate, or minimize flooding events; and

WHEREAS, additional evaluation of the existing infrastructure and development of measures to address flooding and drainage are needed to allow for growth and development within the City Limits and ETJ while protecting the health, safety, environment, quality of life, and general welfare of its residents; and

WHEREAS, the City has retained a planning consultant firm for the purpose of evaluating the City’s historic, current and anticipated construction attributes, and is developing new standards to preserve the quality of life and to protect the health, safety, and general welfare of the citizens of the City and to direct and manage the rapid growth that is now occurring; and

WHEREAS, the City is in the process of studying and evaluating the impact of further development; appropriate impervious cover limitations; the need for drainage and detention improvements; appropriate zoning districts and district regulations; appropriate cut and fill regulations; and issues that will affect future growth and development of the area within its jurisdiction; and

WHEREAS, the City is in the process of seeking additional community input; and

WHEREAS, the City is in the process of studying and updating its development

ordinances and procedures in order to clarify and improve its planning policies based on the forthcoming regulations, to strengthen the connection between the City's Code of Ordinances and the goals and needs of the City's residents, and to protect the health, safety, environment, quality of life, and general welfare of its residents; and

WHEREAS, in order for the City to have adequate and reasonable time to continue to review, evaluate, and revise the City's development ordinances, and to continue to consider the impact of the ordinances upon future growth, public health and safety, development, the natural environment, and the place of architectural improvements, and ecological importance and significance within the City Limits and ETJ, the City wishes to continue to maintain the *status quo* by extending the temporary moratorium, during which certain applications for development permits and/or approvals will continue to be suspended; and

WHEREAS, the purpose of prohibiting certain applications for development permits and/or approvals during this study period includes, within limitation, preserving the *status quo* during the planning process, eliminating incentives for hasty applications, facilitating thoughtful and consistent planning, avoiding exploitation of the delays inherent in the municipal legislative process, and preventing applications from undermining the effectiveness of the revised rules by applying for permits and/or approvals in order to avoid the application of new, possibly more restrictive, development regulations; and

WHEREAS, the City Council has identified and considered evidence demonstrating that applying existing development ordinances or regulations and other applicable laws is inadequate to prevent the new development from causing the overcapacity of municipal and private drainage infrastructure or being detrimental to the public health, safety, and welfare in an affected geographical area, that being the City of Bastrop's City Limits and ETJ; and

WHEREAS, the City Council has identified and considered evidence including that presented by City of staff, consulting engineering firms, FEMA, and observed during site visits demonstrating the extent of need beyond the estimated capacity of existing essential public and private drainage facilities that is expected to result from new property development, including identifying essential public facilities that are currently operating near, at, or beyond capacity in an affected area, that being the City Limits and ETJ; and

WHEREAS, the City Council has identified and considered evidence that alternative methods of achieving the objectives of the moratorium are unsatisfactory, and demonstrating that the municipality has approved a working plan and time schedule for achieving the objectives of the moratorium; and

WHEREAS, the City's program for addressing drainage issues during the extension of the temporary moratorium includes planning, regulating, building, and educating; and

WHEREAS, the City Council passed Emergency Ordinance No. 2018-1, which established a Temporary Moratorium commencing on August 23, 2018, and created a short-term freeze on the acceptance of applications for subdivision, building permits, or development permits for the purpose of preserving the status quo in order to allow the Council reasonable time to review, conduct research, receive public input, evaluate and establish reasonable policies, and prepare a comprehensive subdivision ordinance for future adoption; and

WHEREAS, the City Council passed Emergency Ordinance No. 2018-2-A, which established additional requirements mandating data related to drainage and flooding for the acceptance, processing, and approval of certain projects in the city limits and the extraterritorial jurisdiction during the moratorium; and

WHEREAS, the additional requirements mandated by Emergency Ordinance No. 2018-2-A have given the City the ability to assess the impact of these projects on potential future flooding events; and

WHEREAS, the City Council adopted a temporary process that allows development to continue in the City of Bastrop requiring projects to be evaluated on a case-by-case basis through pre-application meetings and conformity to specific interim drainage measures to ensure that detrimental development does not occur; and

WHEREAS, the temporary process is considered a successful interim solution as of October 31, 2018 having held 41 individual pre-application meetings, issued 212 permits since the inception of the moratorium including 17 new single-family residential, five (5) commercial remodels, one (1) new office complex, and two (2) commercial finish-out permits, and prevented one (1) house from being built in a drainage area; and

WHEREAS, the City has retained a planning consultant firm for the purpose of evaluating the City's historic, current and anticipated construction attributes, and is developing new standards to preserve the quality of life and to protect the health, safety, and general welfare of the citizens of the City and to direct and manage the rapid growth that is now occurring; and

WHEREAS, the City's planning consulting firm has completed both an in-depth analysis of Downtown Bastrop's DNA and how it functions as a complete neighborhood and an extensive evaluation of the City's current development codes that identified significant challenges and code conflicts that are not aligned with the City's Comprehensive Plan 2036 or considered fiscally sustainable or geographically sensitive; and

WHEREAS, the City desires to complete and adopt new development standards including establishing appropriate drainage regulations including impervious cover limitations; appropriate zoning districts and district regulations; appropriate cut and fill regulations; and address identified issues that will affect future growth and development of the area within its jurisdiction; and

WHEREAS, the adoption process of new development standards will require community input and will take additional amount of time to complete; and

WHEREAS, without the additional requirements mandated by Emergency Ordinance No. 2018-2, the City's review process for drainage and stormwater improvements throughout the City Limits and Extraterritorial Jurisdiction would revert to being inadequate and insufficient to prevent, mitigate, or minimize future flooding events.

WHEREAS, Local Government Code Section 212.136 allows a city to extend a moratorium after holding a public hearing on the proposed extension of the moratorium; and adopting written findings that identify the problem requiring the need for extending the

moratorium; describe the reasonable progress made to alleviate the problem; and specify a definite duration for the renewal period of the moratorium.

WHEREAS, the City a public hearing on the proposed extension of the moratorium is set for November 15, 2018.

WHEREAS, the City finds that the original 90 days for the moratorium was insufficient to complete the series of regulatory modifications, and infrastructure improvements, and thus the extension is necessary

WHEREAS, the City Council finds that an extension of the moratorium is necessary to provide the City with the time necessary to continue to properly conduct research, confer with experts, and solicit public input from residents, business owners, property owners, realtors and developers; and

WHEREAS, in recognition of the importance of development permits and/ or approvals to the community, the City desires to extend this moratorium through May 21, 2019, and to include a waiver provision in accordance with Texas Local Government Code Chapter 212, Subchapter E.

WHEREAS, the City Council finds that the City's review process for drainage and stormwater improvements throughout the City Limits and ETJ are, without the pre-submission meeting and engineering certification requirements implemented in Emergency Ordinance No. 2018-2, inadequate and insufficient to prevent, mitigate, or minimize future flooding events; and

NOW, THEREFORE, BE IT ORDAINED BY THE CITY COUNCIL OF THE CITY OF BASTROP, TEXAS, AS FOLLOWS:

SECTION 1. FINDINGS OF FACT: The foregoing recitals are based on evidence presented to the City Council, and are hereby incorporated into this Ordinance by reference as legislative findings of fact as if expressly set forth herein.

SECTION 2. DEFINITIONS: As used in this Ordinance, these terms shall be defined as follows. Terms appearing in this Ordinance but not defined herein shall have the meanings provided in the City's Code of Ordinances, or if not defined by the City then the common meanings in accordance with ordinary usage or as defined in applicable state statutes.

- 1. Commercial Property:** means property zoned for or otherwise authorized for use other than single-family use, multifamily use, heavy industrial use, or use as a quarry.
- 2. Essential Public Facilities:** means water, sewer, or storm drainage facilities or street improvements provided by a municipality or private utility.
- 3. Impervious cover:** means structures, buildings, parking areas, roads, and other impermeable man-made improvements covering the natural land surface that prevents infiltration of water.
- 4. Permit:** means a license, certificate, approval, registration, consent, permit, contract or

other agreement for construction related to, or provision of, service from a water or wastewater utility owned, operated, or controlled by a regulatory agency, or other form of authorization required by law, rule, regulation, order, or ordinance that a person must obtain to perform an action or initiate, continue, or complete a project for which the permit is sought.

The term does not include Trade Permits, which are excluded from this Ordinance.

5. Project: means an endeavor over which a regulatory agency exerts its jurisdiction and for which one (1) or more permits are required to initiate, continue, or complete the endeavor.

6. Property Development: means the construction, reconstruction, or other alteration or improvement of residential or commercial buildings or the subdivision or replatting of a subdivision of residential or commercial property.

7. Property Owner: means the record owner of real property, or their designated agents (i.e., those holding Power of Attorney or other written authorization to act on behalf of the owner).

8. Residential Property: means property zoned for or otherwise authorized for single-family or multi-family use.

9. Trade Permits: means permits required by the City's Code of Ordinances for the following work by skilled tradesmen: Electrical, HVAC, Mechanical, and Plumbing. For purposes of this Ordinance, the term also includes Roofing and Irrigation permits.

SECTION 3. APPLICABILITY: The City of Bastrop hereby enacts this Ordinance in order to extend the temporary moratorium on the acceptance and processing of certain applications and issuance of particular Permits and other forms of municipal authorizations related to specific construction and land development activities. This temporary moratorium applies to all city zoning district uses within the City Limits and the ETJ.

Unless a project falls within an Exception (as provided below), this temporary moratorium applies to all applications for property development Permits.

SECTION 4. PURPOSE: This temporary moratorium was enacted and is being extended to maintain the *status quo*, and to:

1. assess the short-term and long-term comprehensive plan;
2. evaluate regulations for platting and site development;
3. review the City's policies on the acceptance of applications for municipal permits for construction or development;
4. update the City's permitting and planning requirements and processes for drainage and stormwater; and
5. obtain and review public input and expert guidance.

SECTION 5. ENACTMENT: The City of Bastrop hereby enacts this Ordinance extending the temporary moratorium on the City's acceptance, review, approval, and issuance of permits in the City Limits and ETJ. The requirements mandated by Emergency Ordinance No. 2018-2-A continue to apply.

SECTION 6. DURATION: The extension of the temporary moratorium shall be through May 21, 2019, or until the repeal of this Ordinance by the City, whichever is sooner.

SECTION 7. EXTENSION: If the City determines that this extension is insufficient for the City to fully complete its study and planning, this Ordinance may be renewed or extended for an additional period of time necessary to complete the study and implement the recommended changes to City codes, policies, and processes in accordance with the time limits as provided by law upon a majority vote of the City Council.

SECTION 8. EXCEPTIONS AND EXEMPTIONS:

A. Exceptions.

1. **No Impact Projects.** The temporary moratorium extended by this Ordinance does not apply to a project that does not: (a) increase horizontal density, (b) increase or impact impervious cover, (c) expand the footprint of an existing structure, or (d) alter the current drainage pattern on the property.
2. **Ongoing Projects.** The temporary moratorium extended by this Ordinance does not apply to any projects for which construction is currently, actively in progress, and for which valid City permits have been issued and have not expired (as of the date of the temporary moratorium).
3. **Grandfathered Projects.** The temporary moratorium extended by this Ordinance shall not apply to projects that are grandfathered under as provided by state law. Property owners asserting grandfathered rights under Texas Local Government Code Chapter 245 must submit an application claiming an exception to this temporary moratorium to the planning department for review in accordance with City policy.

B. Exemptions. Any property owner who does not assert rights under Texas Local Government Code Chapter 245, but who seeks authorization to proceed with the development permitting process during the time of the temporary moratorium can request the following alternative forms of approval:

1. **Planned Development District:** Property owners with an approval granted by the City Council including enactment of customized zoning regulations through negotiations of specialized rules applicable solely to the proposed project may apply for waiver in accordance with City policy.
2. **Alternate Design Standards:** Property owners with a negotiated approval granted by the City Council for the construction of drainage infrastructure that

exceeds the current standards in the code of ordinances may apply for waiver in accordance with City policy.

3. **ETJ Development Agreement:** Property owners with a negotiated approval granted by the City Council providing for construction standards, platting and development rules pursuant to Texas Local Government Code Chapter 212, Subchapter G may apply for waiver in accordance with City policy.
4. **Waiver:** Property owners agreeing to construct certain drainage infrastructure at property owners' sole expense, in accordance with Texas Local Government Code Chapter 212, Subchapter E may apply for waiver in accordance with city policy.

SECTION 9. DETERMINATIONS & APPEALS

- A. **Determinations.** The Interim Planning Department Director or their designee shall make all initial determinations regarding the status of all projects seeking to apply for permits during this temporary moratorium and recognition of all Exceptions (as provided herein).
- B. **Appeals.** Property Owners seeking to challenge a determination made by the Interim Planning Department Director may appeal that initial determination to the City Manager. Secondary determinations of the City Manager may be appealed to the City Council, whose decision shall be final.
- C. **Exemptions.** The decision to approve an Exemption (as provided for above) shall rest solely with the City Council.

SECTION 10. REPEALER: In the case of any conflict between the other provisions of this Ordinance and any existing Ordinance of the City, the provisions of this Ordinance will control.

SECTION 11. SEVERABILITY: If any provision of this Ordinance or the application thereof to any person or circumstances is held invalid, that invalidity or the unenforceability will not affect any other provisions or applications of this Ordinance that can be given effect without the invalid provision.

SECTION 12. ENFORCEMENT: The City shall have the power to administer and enforce the provisions of this Ordinance as may be required by governing law. Any person violating any provision of this temporary moratorium is subject to suit for injunctive relief as well as prosecution for criminal violations, and such violation is hereby declared to be a nuisance.

Nothing in this Ordinance shall be construed as a waiver of the City's right to bring a civil action to enforce the provisions of this Ordinance and to seek remedies as allowed by law and/or equity.

SECTION 13. EFFECTIVE DATE: This Ordinance shall be effective immediately upon passage and publication, as provided by Texas Local Government Code Chapter 212, Subchapter E.

SECTION 14. PROPER NOTICE & MEETING: It is hereby officially found and determined that the meeting at which this Ordinance was passed was open to the public, and that public notice of the time, place and purpose of said meeting was given as required by the Open Meetings Act, Texas Government Code, Chapter 551. Notice and a public hearing were also provided as required by Texas Government Code Chapter 212, Subchapter E.

READ & ACKNOWLEDGED on First Reading on the 13th day of November 2018.

READ & APPROVED on the Second Reading on the 15th day of November 2018.

APPROVED:

by: _____
Connie B. Schroeder, Mayor

ATTEST:

Ann Franklin, City Secretary

APPROVED AS TO FORM:

Alan Bojorquez, City Attorney



STAFF REPORT

MEETING DATE: November 13, 2018

AGENDA ITEM: 9C

TITLE:

Hold public hearing and consider action to approve Ordinance No. 2018-33 of the City Council of the City of Bastrop, Texas, granting a Conditional Use Permit to allow a manufactured house on 0.572 acres of Farm Lot 65, East of Main Street, located at 1603 State Highway 95, an area zoned A/OS, Agricultural/Open Space, within the city limits of Bastrop, Texas; as shown in Exhibits A and B; setting out conditions; including a severability clause; establishing an effective date and motion to include on the November 27, 2018 Consent Agenda.

STAFF REPRESENTATIVE:

Jennifer C. Bills, AICP, LEED AP, Assistant Planning Director

ITEM DETAILS:

Site Address: 1603 State Highway 95 (Exhibit A)
Total Acreage: 0.572 acres
Legal Description: 0.572 acres of Farm Lot 65, East of Main Street

Property Owner: Lossie Peterson
Applicant Contact(s): Valerie Kugle

Existing Use: Vacant/Residential – structure demolished 2018
Existing Zoning: AO/S – Agricultural Open Space (Attachment 4)
Future Land Use: Transitional Residential

BACKGROUND/HISTORY:

The applicant is applying for a Conditional Use Permit, which is required to install a Manufactured Home on a property zoned Agricultural/Open Space. The property previously had a single-family home on the lot that was demolished in February 2018, due to damage that was sustained in the 2015 floods. The site had an onsite septic facility, but with the demolition of the structure, the existing septic was deemed as insufficient for a new structure. The property owner was granted a variance to the requirement to connect to city wastewater on September 11, 2018 and a new on-site sewer facility (OSSF) will have to be permitted and installed by the property owner with the installation of the home.

The proposed manufactured home is 24 feet by 44 feet (1056 square feet) and includes a recessed front porch and covered parking (carport) attached to the structure.

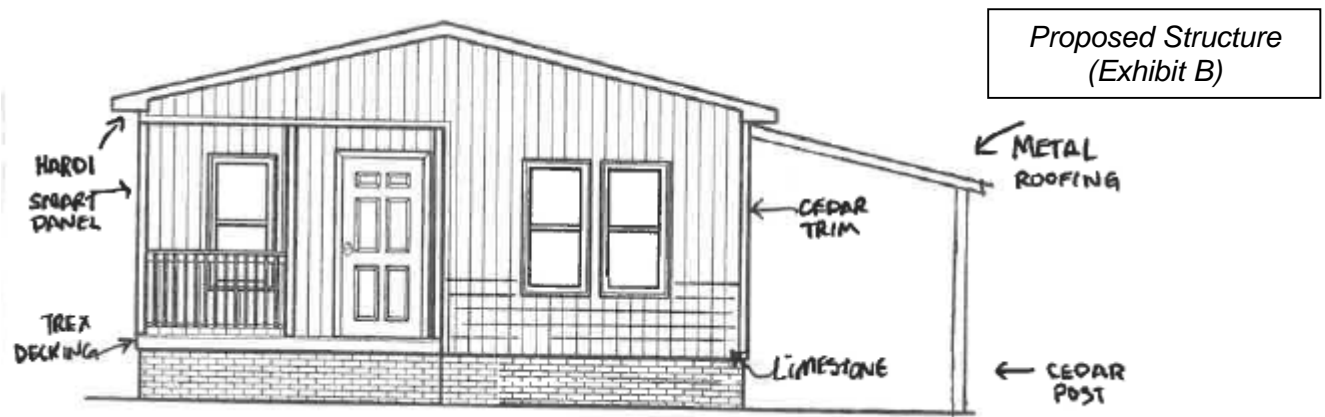

POLICY EXPLANATION:

The purpose of conditional uses is to allow certain uses in districts that under some circumstances would not be compatible with other permitted uses, but may be compatible if certain conditions and development restrictions are met. A Conditional Use Permit (CUP) is adopted by Ordinance, similar to a standard zoning request, with public hearings at Planning & Zoning Commission and City Council, as well as two ordinance readings at separate City Council meetings.

Section 33.2 of the Zoning Ordinance states that the Planning and Zoning Commission may consider the following criteria when approving a CUP:

- i. The use is harmonious and compatible with surrounding existing uses or proposed uses; *The surrounding land use is undeveloped land. The Future Land Use Plan designates this area a Transitional Residential.*
- ii. The activities requested by the applicant are normally associated with the permitted uses in the base district; *Single-family uses are one of the primary uses of the Agriculture/Open Space zoning district.*
- iii. The nature of the use is reasonable; *The requested use will continue the previous single-family use.*
- iv. Any negative impact on the surrounding area has been mitigated; *The proposed structure will be oriented with the front door facing the street and the carport will be flush with the front façade of the house (not in front of the structure).*
- v. Any additional conditions specified [to] ensure that the intent of the district purposes are being upheld.

A property survey will be required for the building permit review that accurately shows the property boundaries and location of the OSSF.

Street Facing Façade
(Attachment 2)



Per Section 35.4, Special and Supplemental Requirements, all manufactured homes approved through a Manufactured Home Overlay or Conditional Use Permit, must satisfy the following requirements:

- A. All dwelling units shall be HUD-code manufactured home units.
Proposed structure complies with this requirement.
- B. Anchorage of Manufactured Homes: To insure against natural hazards such as tornadoes, high winds, and electrical storms, anchorage at each manufactured home shall be provided, at the time of installation, according to the Building Code.
Will be reviewed during permitting and installation.
- C. Skirting:
 - 1. All manufactured home units not attached to a permanent foundation shall provide weather resistant skirting, at the time of installation, from the top of the unit's frame to grade. Skirting shall totally enclose and secure from view the unit's axles and all required anchors, footings, and piers.
 - 2. All required skirting shall be of a texture and color similar to the materials used in the construction of the manufactured home unit.
Proposed rendering complies with this requirement.
- D. Two (2) off-street parking spaces must be provided. One must be covered (carport/garage) and must meet the setback requirements. A building permit must be submitted for this carport or garage within two (2) months from the date the manufactured home was installed. The carport or garage must be built within six (6) months from the date the manufactured home was installed.

Carport is shown in the proposal and complies with this requirement.

- E. The main roof shall be pitched, rather than flat.
Proposed structure complies with this requirement.
- F. The manufactured home must be sited with its longest dimension parallel to the street.
This requirement was intended to ensure that the front door of the structure faces the street. Historically, manufactured homes had the primary entrance on the longer side. The proposed structure has the front door facing the street.
- G. The exterior finish cannot have a high-gloss finish. The exterior walls shall look like wood or masonry, regardless of the actual composition.
The proposed finishes are a mix of wood, stone and Hardiplank materials.
- H. The hitch must be removed.
Will be reviewed during permitting and installation.
- I. The lot must be landscaped so that it is equivalent to the average amount of landscaping that exists on the adjoining lots. At a minimum, two (2) trees of the large variety and two (2) shrubs must be provided. Furthermore, the entire lot must be sodded with grass.
The existing lot already has established ground cover and trees. This will be reviewed during permitting and installation for compliance.
- J. The manufactured home must have a minimum floor area of one thousand (1000) square feet.
Proposed structure complies with this requirement.
- K. A manufactured home that is not being placed within a Manufactured Home Park or subdivision must have a minimum width of at least twenty-eight feet (28').
Proposed structure is 24 feet by 44 feet, with the 24 foot side parallel to the street. This requirement is intended to restrict manufactured homes that were often three to five times longer than the width (e.g. 14 feet by 72 feet). Newer manufactured homes come in a wider variety of sizes. This model has ratio of 1.8 times the width to depth ratio, which is a ratio which would be seen in site built homes.
- L. A manufactured home that is not being placed within a manufactured home park or subdivision shall have a gabled entry or other such break in the facade or roof line. *The proposed structure has a break in the front façade for a front porch, giving the structure some architectural detail.*

PUBLIC COMMENTS:

Property owner notifications were mailed to four adjacent property owners on October 8, 2018. At the time of this report, no responses had been received (Attachment 3).

PLANNING & ZONING COMMISSION RECOMMENDATION:

At the October 25, 2018 meeting, the P&Z Commission recommended by a vote of 8-1 to approve the request for a Conditional Use Permit for a manufactured home, with the conditions included by staff.

The Commission discussed the location of the carport. The proposed location of the carport is to the right side of the house and will not protrude in front of the front façade. Questions were asked if the parking could be located behind the building. The applicant stated the side door to the structure is located on the side where the covered parking would be located. Additionally, the A/OS setback is 50 feet, which is twice the required setback in SF-7, Single-family Residential. The Commission did not amend the conditions regarding the proposed parking location.

RECOMMENDATION:

Hold a public hearing and consider action to recommend approval on ordinance for a Conditional Use Permit to allow a manufactured house on 0.572 acres of Farm Lot 65, East of Main Street located at 1603 State Highway 95, an area zoned A/OS, Agricultural/Open Space, within the city limits of Bastrop and forward to the next City Council meeting.

1. Construction and permits submitted shall be in conformance with the City of Bastrop regulations and shall meet the special requirements of Section 35.4 as detailed in the report, including an all-weather surface driveway and parking area.
2. All necessary permits for the proposed development shall be acquired prior to construction/movement of the manufactured home on the subject property.
3. A Building Permit shall be applied for and secured within one (1) year from the date the conditional use permit is granted (second reading of the ordinance).
4. A property survey will be required for the building permit review that accurately shows the property boundaries and location of the OSSF.

ATTACHMENTS:

Exhibit A: Property Location Map
Exhibit B: Proposed Building Floor Plan & Elevations
Attachment 1: Pictures of Structure
Attachment 2: Conceptual Site Plan
Attachment 3: Property Owner's Notification
Attachment 4: Zoning Map

ORDINANCE 2018-33

AN ORDINANCE OF THE CITY COUNCIL OF THE CITY OF BASTROP, TEXAS GRANTING A CONDITIONAL USE PERMIT TO ALLOW A MANUFACTURED HOUSE ON 0.572 ACRES OF FARM LOT 65, EAST OF MAIN STREET, LOCATED AT 1603 STATE HIGHWAY 95, AN AREA ZONED A/OS, AGRICULTURAL/OPEN SPACE, WITHIN THE CITY LIMITS OF BASTROP, TEXAS; AS SHOWN IN EXHIBITS A AND B; SETTING OUT CONDITIONS; INCLUDING A SEVERABILITY CLAUSE; AND ESTABLISHING AN EFFECTIVE DATE.

WHEREAS, Lossie Peterson (the "Owner") submitted a request for a Conditional Use Permit (CUP) for a manufactured house on 0.572 acres of Farm Lot 65, East of Main Street, located at 1603 State Highway 95, within the City limits of Bastrop, Texas, hereinafter referred to as "the Property"; and

WHEREAS, a location map is attached hereto as Exhibit "A" (the "Property"); and

WHEREAS, the Property is currently zoned as Agricultural/Open Space (A/OS); and

WHEREAS, pursuant to Section 10.4 of the City's Zoning Ordinance, notice of the CUP was given to all property owners located within two hundred (200) feet of the Property, and the Planning and Zoning Commission of the City of Bastrop held a public hearing on the CUP request on October 8, 2018; and

WHEREAS, the owner's proposed development, with the stated conditions, meets the intent of the Zoning Ordinance, Section 33.2, Conditional Use Permit criteria and Section 35.4, Special and Supplemental Requirements for manufactured homes; and

WHEREAS, after notice and hearing, the Planning and Zoning Commission, by a vote of 8-1, recommended approval of the proposed request, subject to certain conditions set forth herein; and

WHEREAS, after consideration of public input received at the hearing, the information provided by the Applicant, and all other information presented, City Council finds by a majority vote of all members that it is in the public interest to approve the CUP.

NOW THEREFORE, BE IT ORDAINED BY THE CITY COUNCIL OF THE CITY OF BASTROP, TEXAS THAT:

Section 1: A Conditional Use Permit for a manufactured house, situated on 0.572 acres of Farm Lot 65, East of Main Street, located at 1603 State Highway 95, within the city limits of Bastrop, Texas as more particularly shown on Exhibits "A" and "B", shall be and is hereby approved with the following conditions to:

- a. Construction shall be in conformance with the City of Bastrop regulations.
- b. All necessary permits for the proposed development shall be acquired prior to occupying the building.
- c. A Building Permit shall be applied for and secured within one year from the date

the Conditional Use Permit is granted (second reading of the ordinance).

- d. A property survey will be required for the building permit review that accurately shows the property boundaries and location of the OSSF.

Section 2: If any provision of this ordinance or application thereof to any person or circumstance shall be held invalid, such invalidity shall not affect the other provisions, or application thereof, of this ordinance, which can be given effect without the invalid provision or application, and to this end, the provisions of this ordinance are hereby declared to be severable.

Section 3: This ordinance shall take effect upon the date of final passage noted below, or when all applicable publication requirements, if any, are satisfied in accordance with the City's Charter, Code of Ordinances, and the laws of the State of Texas.

READ and ACKNOWLEDGED on First Reading on the 13th day of November 2018.

READ and APPROVED on the Second Reading on the 27th day of November 2018.

APPROVED:

Connie B. Schroeder, Mayor

ATTEST:

Ann Franklin, City Secretary

APPROVED AS TO FORM:

Alan Bojorquez, City Attorney

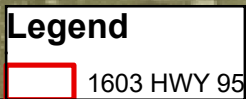
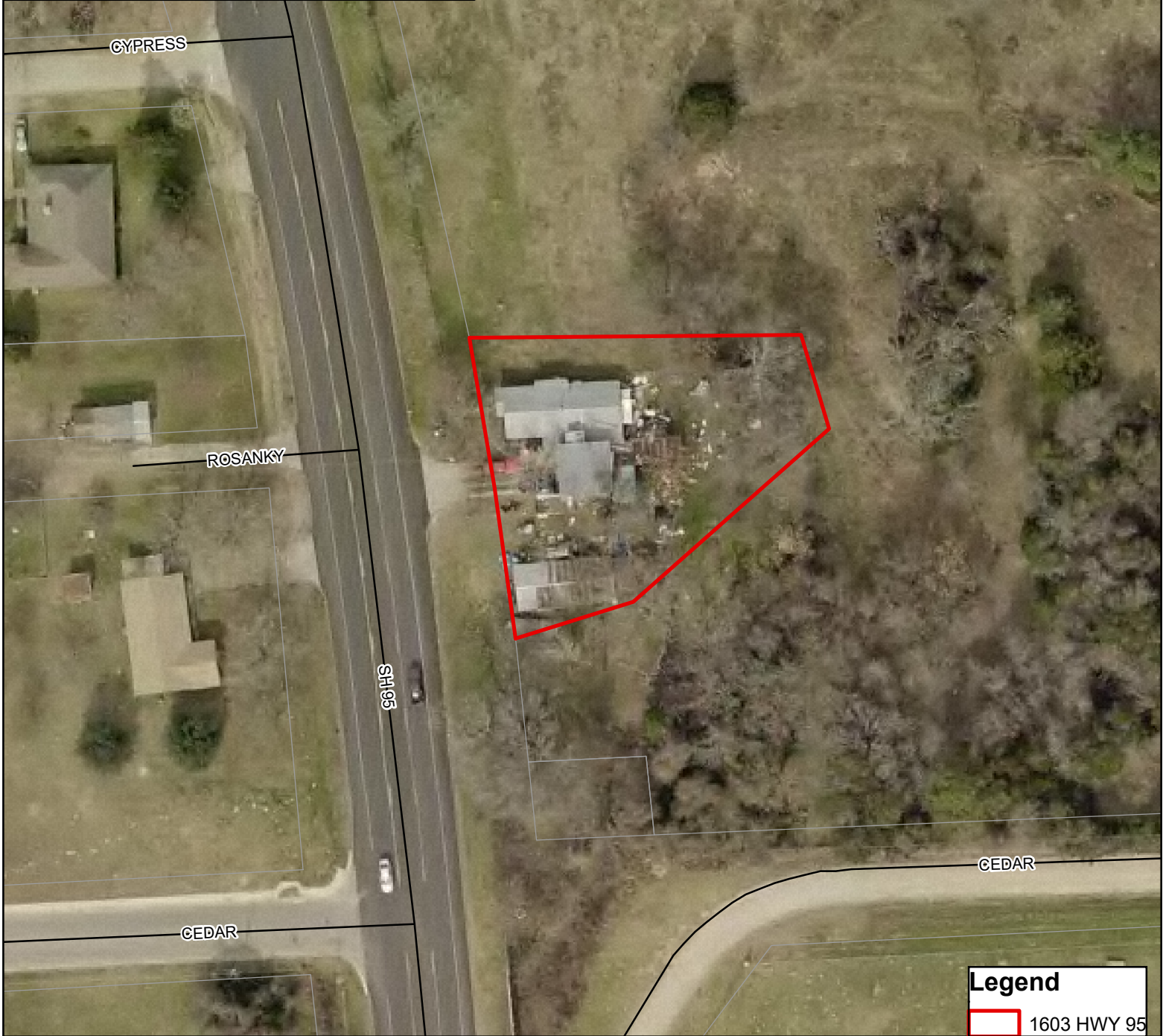
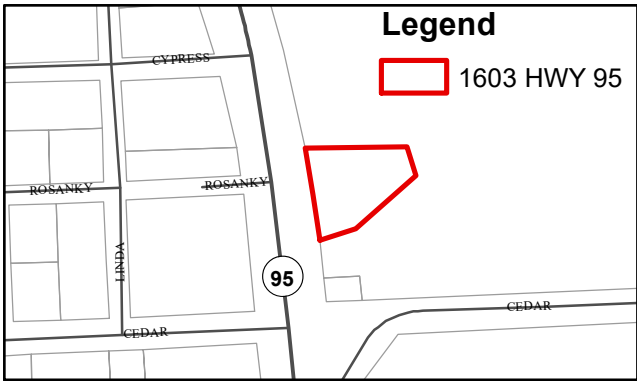

1 inch = 73 feet

Exhibit A
Location Map
1603 HWY 95
Conditional Use Permit for a Manufactured Home



The accuracy and precision of this cartographic data is limited and should be used for information /planning purposes only. This data does not replace surveys conducted by registered Texas land surveyors nor does it constitute an "official" verification of zoning, land use classification, or other classification set forth in local, state, or federal regulatory processes. The City of Bastrop, nor any of its employees, do not make any warranty of merchantability and fitness for particular purpose, or assumes any legal liability or responsibility for the accuracy, completeness or usefulness of any such information, nor does it represent that its use would not infringe upon privately owned rights.

Date: 10/16/2018

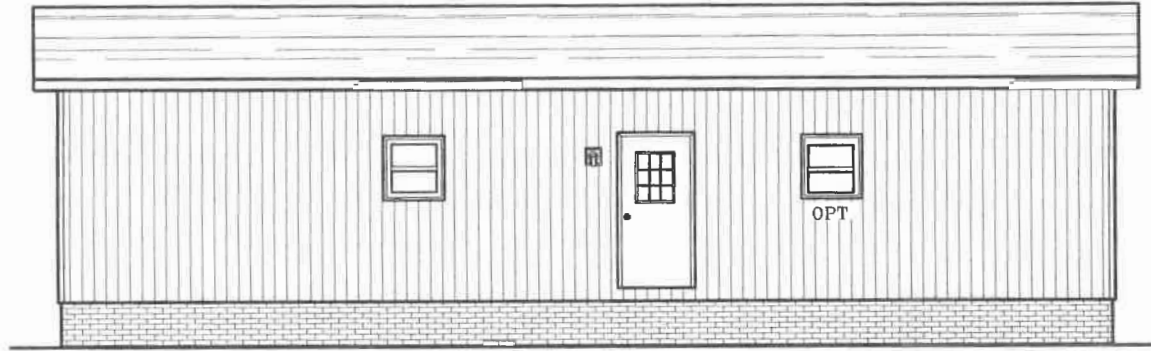

South

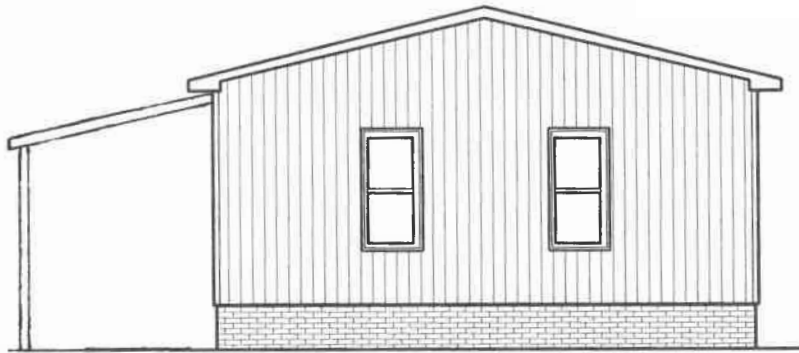

East



West (street facing)

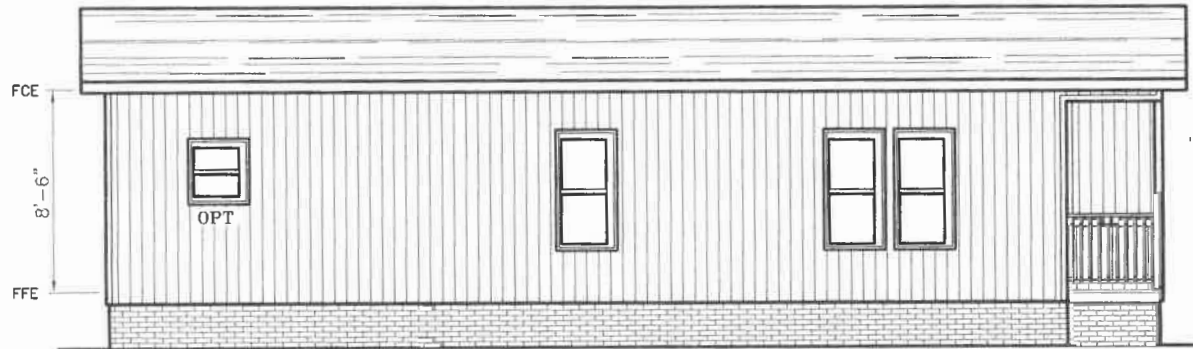

North

<p>OLD DRAWING NUMBER: 32M143</p> <p>997 SQ.FT. (STD PLAN "CONDITIONED")</p> <p>N/A SQ.FT. (W/OPT. PORCH/RECESS "CONDITIONED")</p>		<p>Model #: DEV24442A Drawing #:</p>	
		<p>Date: 1/21/10 Scale: NTS 32M372</p>	
<p>Product Designer: WaltersR</p>		<p>24' x 44' Develo Per</p>	
<p>ELEVATION</p>			

20 lb ROOF LOAD SIDEWALL OPENING PIER LOAD 24' BOX WIDTH	SIDEWALL OPENING (FT) REQUIRED PIER LOAD (LBS)					
	3	4	5	6	8	10
	1100	1240	1380	1520	1800	2080

*FOR 30 lb & 40 lb ROOF LOAD REFER TO TABLES 7b & 7c IN THE INSTALLATION MANUAL.

PIER LOAD 20lb. ROOF LOAD		PIER LOAD 30lb. ROOF LOAD	
COLUMN PIER #	COLUMN LOAD (lbs)	COLUMN PIER #	COLUMN LOAD (lbs)
PIER # 1	740	PIER # 1	1307
PIER # 2	740	PIER # 2	1307
PIER # 3	2738	PIER # 3	4423
PIER # 4	2738	PIER # 4	4423
PIER # 5	2539	PIER # 5	4159
PIER # 6	2539	PIER # 6	4159

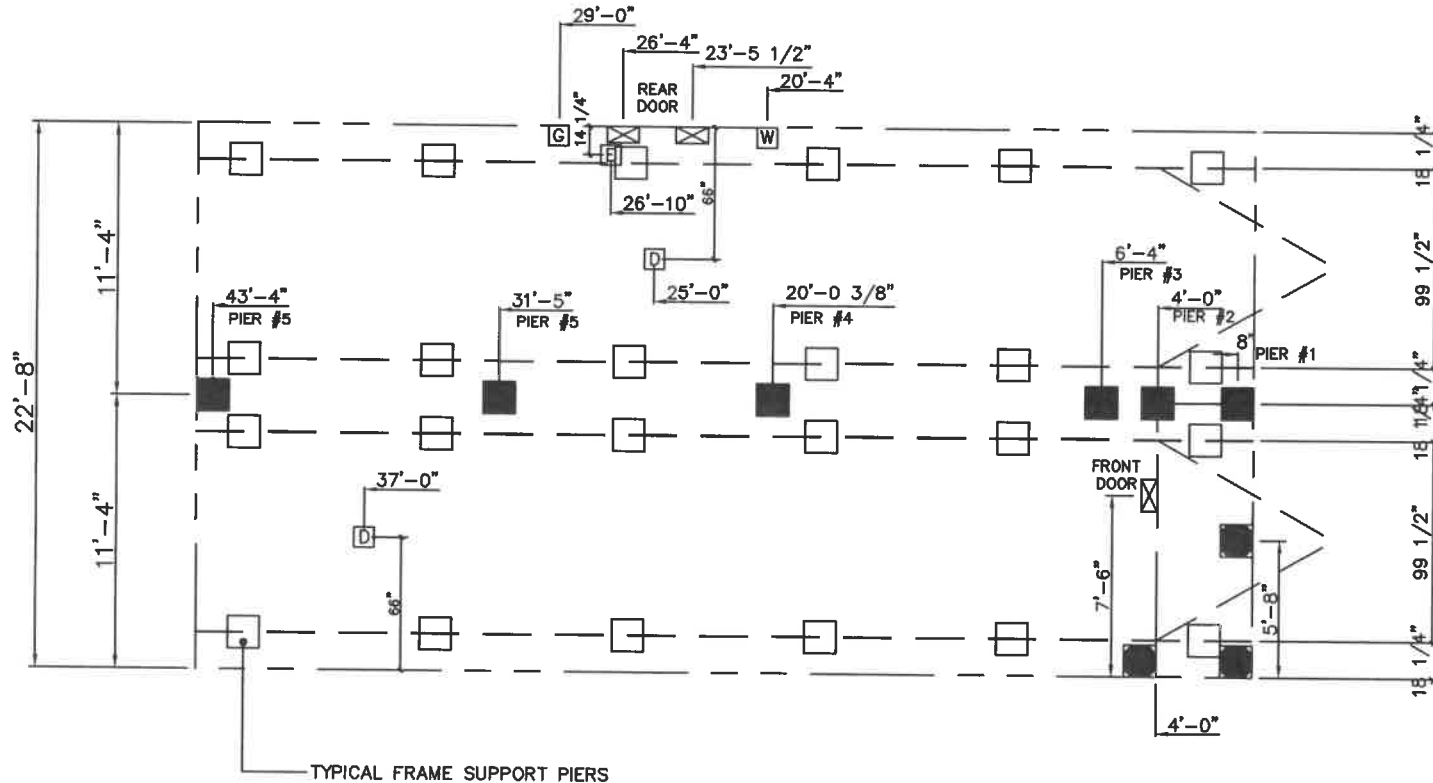

GENERAL NOTES:

- PIER LOADS SHOWN ARE TO BE USED TO SIZE THE FOOTINGS BELOW THE MARRIAGEWALL FOR COLUMN SUPPORT PIERS. REFER TO TABLES 6b AND 6c IN THE INSTALLATION MANUAL FOR LOAD ON FRAME PIER FOOTINGS FOR HOMES THAT DO NOT REQUIRE PERIMETER BLOCKING. REFER TO TABLES 7b AND 7c IN THE INSTALLATION MANUAL FOR LOAD ON FRAME PIER FOOTINGS THAT REQUIRE PERIMETER BLOCKING. REFER TO TABLES 10 AND 10a TO DETERMINE FOOTING SIZE FOR ALL PIERS.
- REFER TO TABLE 9 FOR PIER CONFIGURATION AND MAXIMUM ALLOWABLE HEIGHTS. CROSS REFERENCE THE PIER HEIGHT WITH THE MAXIMUM ALLOWABLE FLOOR HEIGHT LISTED IN THE FRAME TIEDOWN CHARTS (TABLE 18, 19, AND 20).
- FLOOR WIDTH SHOWN IS FOR STANDARD PRODUCT ONLY. CONTACT THE MFG PLANT FOR SPECIFICATIONS OF OPTIONS ORDERED.
- SERVICE DROP LOCATIONS IDENTIFIED ARE APPROXIMATE.
- THE MAXIMUM SPACING FOR FRAME SUPPORT PIERS FOR 8" I-BEAMS IS 8 FEET, 10" & 12" I-BEAMS ARE 10 FEET.

SERVICE DROP LEGEND

- E = ELECTRICAL DROP
- W = WATER INLET
- D = DWV PLUMBING DROP
- G = GAS INLET

PIER LEGEND

- = SUPPORT UNDER MATING OPENING
- = SUPPORT AT MATING COLUMN
- = SUPPORT UNDER MATING WALL
- = PIER PORCH/RECESSED ENTRY
- = PIER MAIN BEAM
- = PIER PERIMETER
- = TIE-DOWN SUPPORT (QTY PER TBL N, SEE DETAIL D-6 IN FOUND. PKG.)

OLD DRAWING NUMBER: 32M143
997 SQ.FT. (STD PLAN "CONDITIONED")
N/A SQ.FT. (W/OPT. PORCH/RECESS "CONDITIONED")

CMH MANUFACTURING	Model #: DEV24442A	Drawing #:
	Date: 12/31/0 Scale: NTS	32M372
Product Designer: WaltersR		24' x 44' Developer
PIER LOADS		

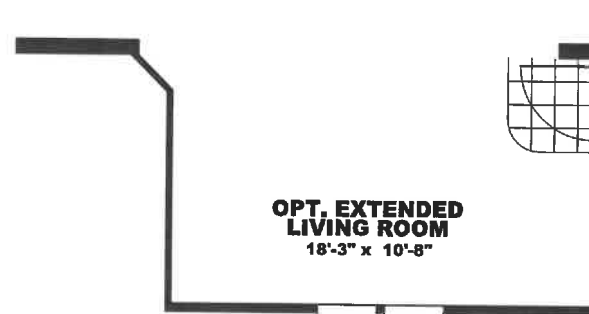
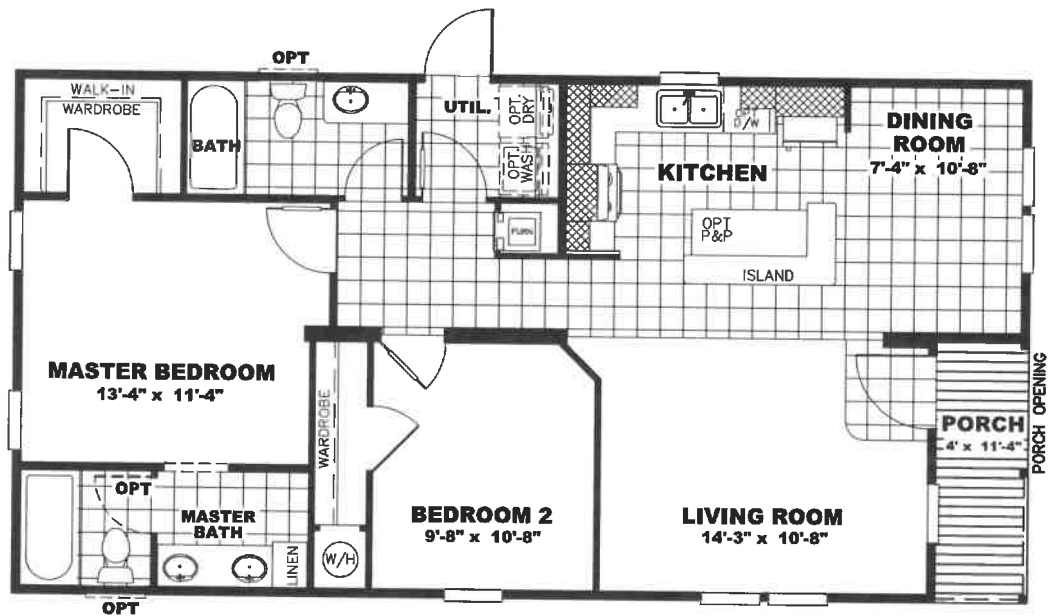

Palmer

Model #: DEV24442A

Drawing #:

32M372

Attachment 1

West (street facing)



North Facade



South Facade



East Facade



Attachment 2

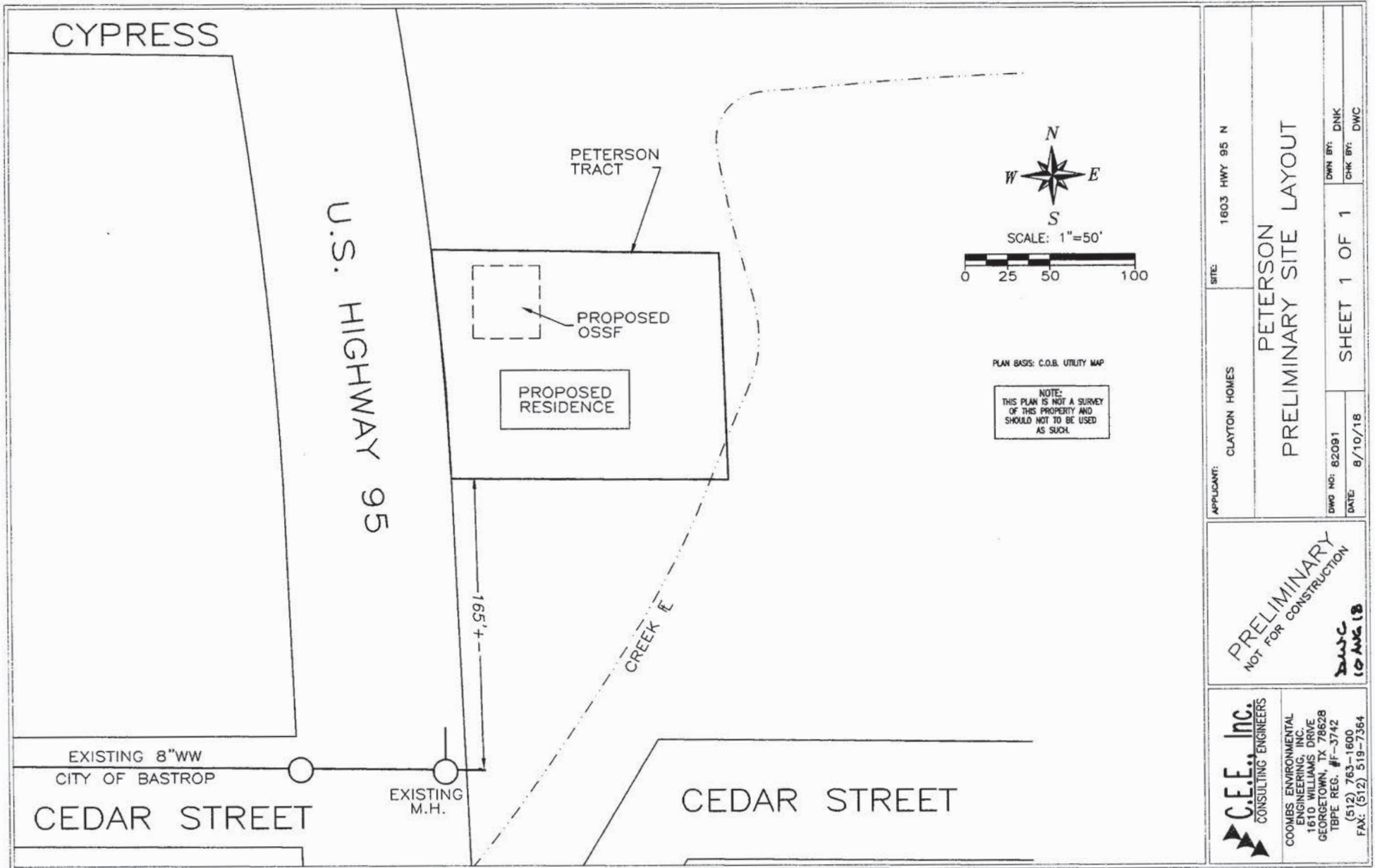

APPLICANT: CLAYTON HOMES 1603 HWY 95 N	SITE: 1603 HWY 95 N	
	PETERSON PRELIMINARY SITE LAYOUT	
DWG NO: 82091 DATE: 8/10/18	SHEET 1 OF 1	DWN BY: DNK CHK BY: DWC
PRELIMINARY NOT FOR CONSTRUCTION DWG 10 AUG 18		
C.E.E. Inc. CONSULTING ENGINEERS COOMBS ENVIRONMENTAL ENGINEERING, INC. 1610 WILLIAMS DRIVE GEORGETOWN, TX 78628 TBPE REG. #F-3742 (512) 763-1600 FAX: (512) 519-7364		



**Notice of Pending Conditional Use Permit Approval
City of Bastrop
Planning & Zoning Commission
And City Council**

Dear Property Owner:

The **Planning and Zoning Commission** will conduct a public hearing on **Thursday, October 25, 2018 at 6:00 p.m.** and the **City Council** will conduct a public hearing (first reading) **Tuesday, November 13, 2018 at 6:30 p.m.** in the **City Hall Council Chambers located at 1311 Chestnut Street, Bastrop, Texas** on the request to approve the ordinance for a Conditional Use Permit to allow a manufactured house on 0.572 acres of Farm Lot 65, East of Main Street located at 1603 State Highway 95, an area zoned A/OS, Agricultural/Open Space, within the city limits of Bastrop.

Applicant/Owner: Valerie Kugle/Lossie Peterson

Address: 1603 State Highway 95

Legal Description: 0.572 acres of Farm Lot 65, East of Main Street

The site location map and a letter from the property owner is attached for reference.

As a property owner within 200 feet of the above referenced property, you are being notified of the upcoming meetings per the Bastrop Code of Ordinances CUP Regulations. For more information on this project, you can contact the Planning & Development offices at (512) 332-8840, plan@cityofbastrop.org, or visit the office at 1311 Chestnut Street, Bastrop, Texas.

For additional information, please visit or call the Planning & Development offices.

✂

**PROPERTY OWNER'S
RESPONSE**

As a property owner within 200': (please check one)

- I am in favor of the request.
- I am opposed to the request.
- I have no objection to the request.

Property Owner Name: _____

Property Address: _____

Phone (optional): _____

Mailing Address: _____

Email (optional): _____

Property Owner's Signature: _____

Comments: (Optional)

Please provide reply to the address below, via fax (512) 332-8829, or email:

plan@cityofbastrop.org

RE:1603 HWY 95 CUP

PLANNING & DEVELOPMENT

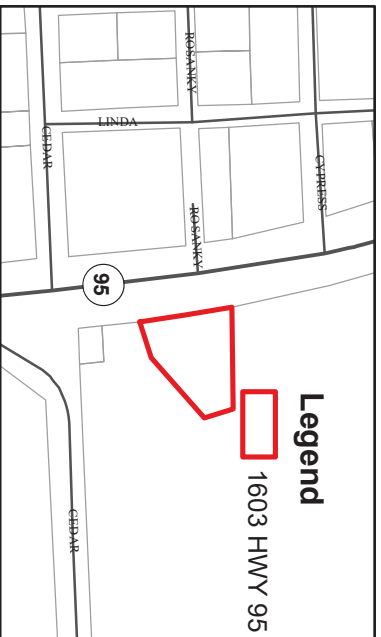

Legend

 1603 HWY 95

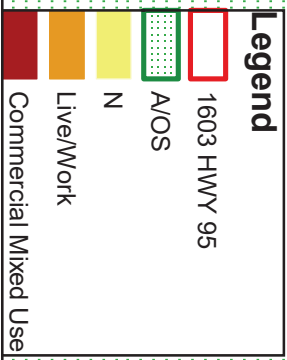

N

The accuracy and precision of this cartographic data is limited and should be used for information /planning purposes only. This data does not replace surveys nor does it constitute an "official" verification of zoning, land use classification, or other classification set forth in local, state, or federal regulatory processes. The City of Bastrop, nor any of its employees, do not make any warranty of merchantability and fitness for particular purpose, or assumes any legal liability or responsibility for the accuracy, completeness or usefulness of any such information, nor does it represent that its use would not infringe upon privately owned rights.

**Attachment 4
Zoning Map
1603 HWY 95
Conditional Use Permit for a Manufactured Home**



1 inch = 73 feet

Date: 10/08/2018

1603 SH 95 CUP

Public hearing and consider action to approve Ordinance 2018-33 of the City Council of the City of Bastrop, Texas, granting a Conditional Use Permit to allow a manufactured house on 0.572 acres of Farm Lot 65, East of Main Street located at 1603 State Highway 95, an area zoned A/OS, Agricultural/Open Space, within the city limits of Bastrop as shown in Exhibits A and B, setting out conditions; including a severability clause; and providing an effective date and motion to include on the November 27, 2018 Consent Agenda.



Request

- Place a new manufactured home on 0.572 acre lot at 1603 SH 95.
- The Zoning Ordinance requires manufactured housing in A/OS zoning to obtain a Conditional Use Permit.



Location

- 1603 State Highway 95



Zoning

- A/OS, Agricultural/Open Space

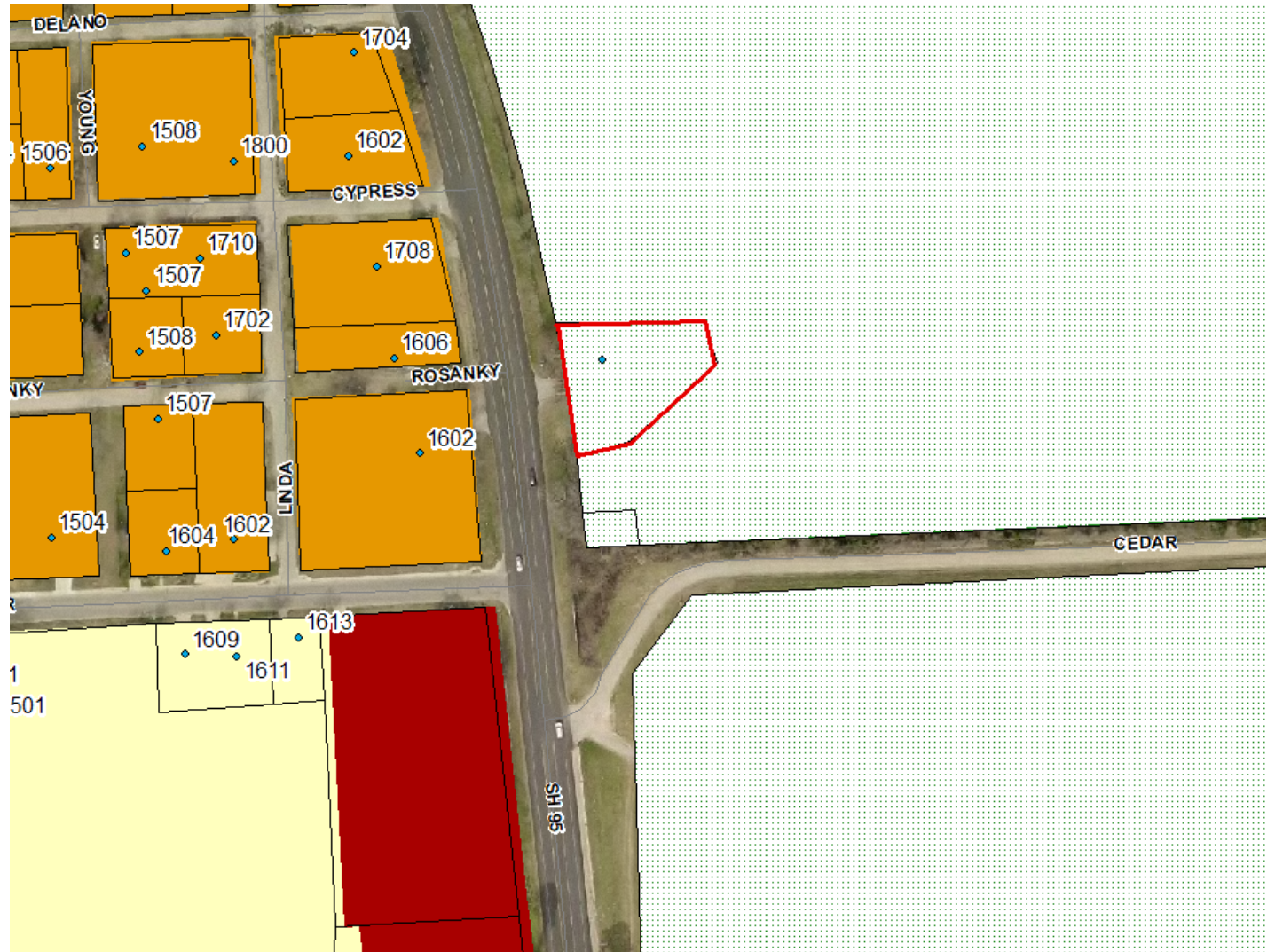

Future Land Use

- Transitional Residential

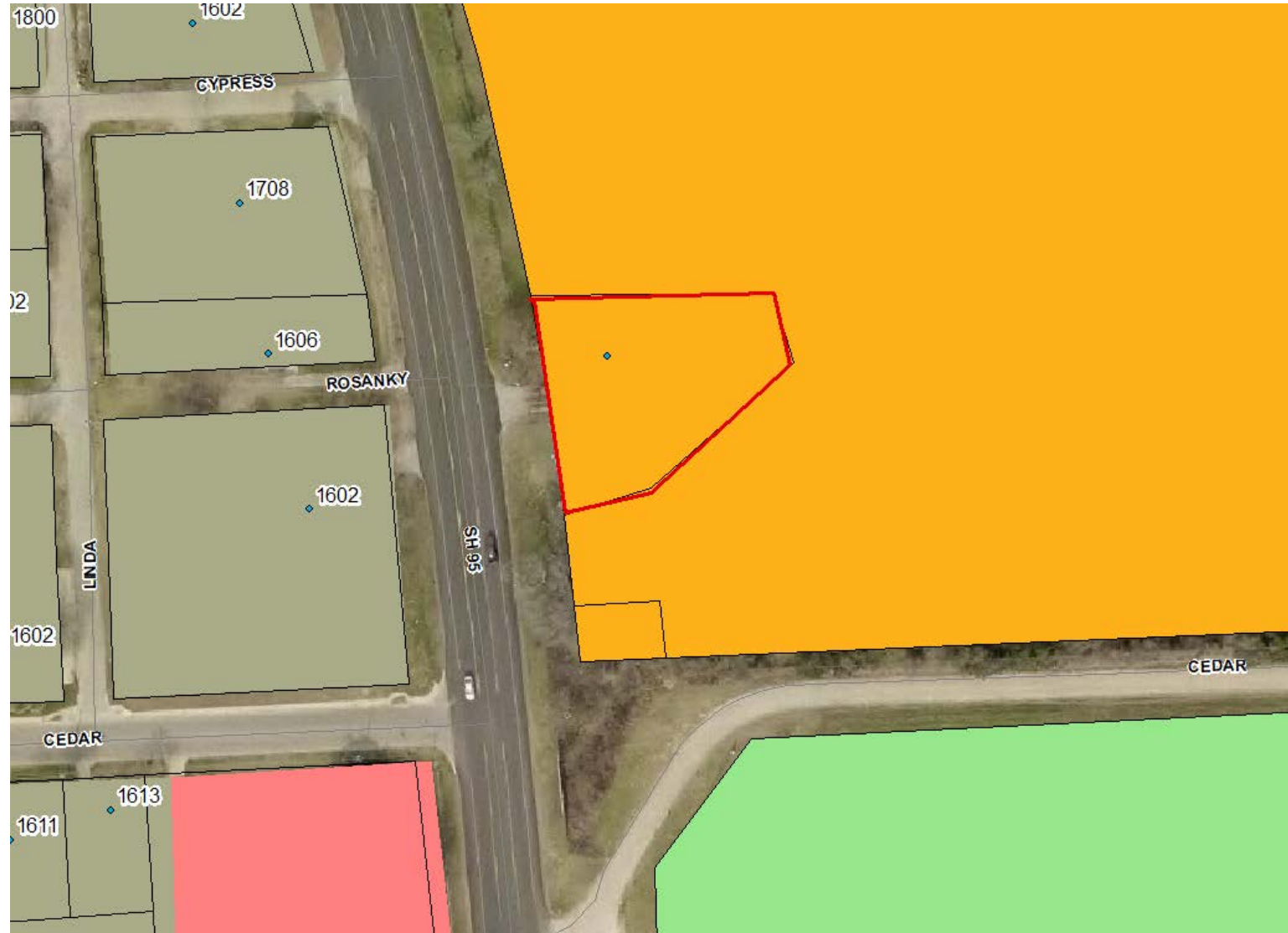

Proposed Structure

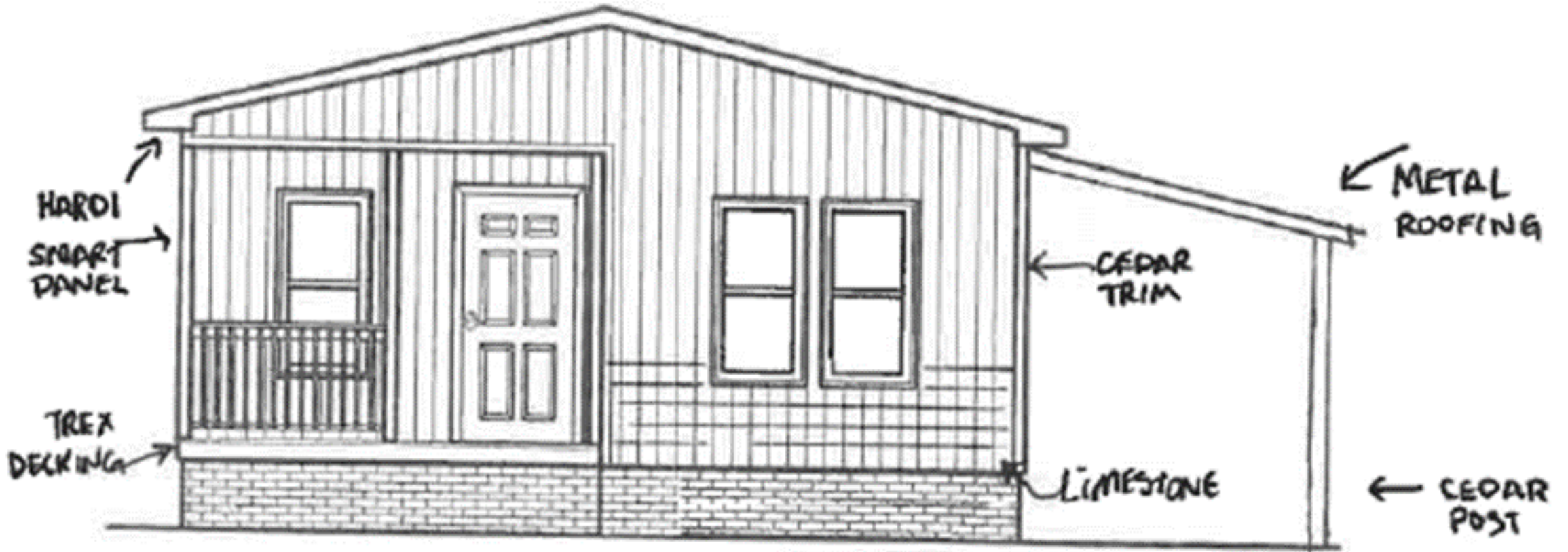

Street Facing Façade



Section 33.2 of the Zoning Ordinance CUP Criteria

- i. The use is harmonious and compatible with surrounding existing uses or proposed uses;
The surrounding land use is undeveloped land. The Future Land Use Plan designates this area as Transitional Residential.
- ii. The activities requested by the applicant are normally associated with the permitted uses in the base district;
Single-family uses are one of the primary uses of the Agriculture/Open Space zoning district.
- iii. The nature of the use is reasonable;
The requested use will continue the previous single-family use.
- iv. Any negative impact on the surrounding area has been mitigated;
The proposed structure will be oriented with the front door facing the street and the carport will be flush with the front façade of the house (not in front of the structure).
- v. Any additional conditions specified [to] ensure that the intent of the district purposes are being upheld.
A property survey will be required for the building permit review that accurately shows the property boundaries and location of the OSSF.



Section 35.4 Special and Supplemental Requirements for Manufactured Home

- A. All dwelling units shall be HUD-code manufactured home units.
- B. Anchorage of Manufactured Homes: To insure against natural hazards such as tornadoes, high winds, and electrical storms, anchorage at each manufactured home shall be provided, at the time of installation, according to the Building Code.
- C. Skirting:
 - 1. All manufactured home units not attached to a permanent foundation shall provide weather resistant skirting, at the time of installation, from the top of the unit's frame to grade. Skirting shall totally enclose and secure from view the unit's axles and all required anchors, footings, and piers.
 - 2. All required skirting shall be of a texture and color similar to the materials used in the construction of the manufactured home unit.
- D. Two (2) off-street parking spaces must be provided. One must be covered (carport/garage) and must meet the setback requirements. A building permit must be submitted for this carport or garage within two (2) months from the date the manufactured home was installed. The carport or garage must be built within six (6) months from the date the manufactured home was installed.



Section 35.4 Special and Supplemental Requirements for Manufactured Home

E. The main roof shall be pitched, rather than flat.

F. The manufactured home must be sited with its longest dimension parallel to the street.

This requirement was intended to ensure that the front door of the structure faces the street. Historically, manufactured homes had the primary entrance on the longer side. The proposed structure has the front door facing the street.

G. The exterior finish cannot have a high-gloss finish. The exterior walls shall look like wood or masonry, regardless of the actual composition.

H. The hitch must be removed.

I. The lot must be landscaped so that it is equivalent to the average amount of landscaping that exists on the adjoining lots. At a minimum, two (2) trees of the large variety and two (2) shrubs must be provided. Furthermore, the entire lot must be sodded with grass.

J. The manufactured home must have a minimum floor area of one thousand (1000) square feet.



Section 35.4 Special and Supplemental Requirements for Manufactured Home

- K. A manufactured home that is not being placed within a Manufactured Home Park or subdivision must have a minimum width of at least twenty-eight feet (28').

Proposed structure is 24 feet by 44 feet, with the 24 foot side parallel to the street. This requirement is intended to restrict manufactured homes that were often three to five times longer than the width (e.g. 14 feet by 72 feet). Newer manufactured homes come in a wider variety of sizes. This model has ratio of 1.8 times the width to depth ratio, which is a ratio which would be seen in site built homes.

- L. A manufactured home that is not being placed within a manufactured home park or subdivision shall have a gabled entry or other such break in the facade or roof line.



Compliance with the Moratorium

- This application is considered grandfathered under Chapter 245 of the Local Government Code and qualifies as an Exception under the moratorium.



Planning & Zoning Commission Report

- By a vote of 8-1, the P&Z recommended granting the CUP with the conditions in the staff report.
- Commissioners discussed the location of the required parking.
 - Proposal show to the right (south)of the structure, by the side door and flush with the front façade.
 - The setback for the zoning district is 50 feet, which is twice the standard in SF-7, Single-family 7 zoning.



Staff Recommendation

Hold a public hearing and consider action to recommend approval an ordinance for a Conditional Use Permit to allow a manufactured house on 0.572 acres of Farm Lot 65, East of Main Street located at 1603 State Highway 95, an area zoned A/OS, Agricultural/Open Space, within the city limits of Bastrop and forward to the next City Council meeting.

1. Construction and permits submitted shall be in conformance with the City of Bastrop regulations and shall meet the special requirements of Section 35.4 as detailed in the report, including an all-weather surface driveway and parking area.
2. All necessary permits for the proposed development shall be acquired prior to construction/movement of the manufactured home on the subject property.
3. A Building Permit shall be applied for and secured within one (1) year from the date the conditional use permit is granted (second reading of the ordinance).
4. A property survey will be required for the building permit review that accurately shows the property boundaries and location of the OSSF.



Questions?





STAFF REPORT

MEETING DATE: November 13th, 2018

AGENDA ITEM: 9D

TITLE:

Consider action to approve Resolution No. R-2018-93 of the City Council of the City of Bastrop, Texas awarding a Community Support Service Agreement for services associated with operating, marketing, and providing cultural art and theater services to the Bastrop Opera House, at a cost of Ninety Two Thousand and Five Hundred and 00/100 Dollars (\$92,500), attached as Exhibit A; authorizing the City Manager to execute all necessary documents for the contract; providing for a repealing clause; and establishing an effective date.

STAFF REPRESENTATIVE:

Sarah O'Brien, Hospitality & Downtown Director

BACKGROUND/HISTORY:

Chapter 351 of the Tax Code provides the requirements on how Hotel Occupancy Tax (HOT) funds may be spent. As prioritized in the FY 18 Budget, Staff has been working to leverage HOT funds to attract tourism and strengthen our sales tax base by maximizing our investment. Staff also continues to work to bring HOT fund users together under the strategic goals and vision that have been developed in line with the Council's Focus Areas, the City's 2018 Work Plan, and the Comprehensive Plan 2036.

The Comprehensive Plan also states that Bastrop's continued emphasis on cultural arts and tourism development through coordinated policies will lead to hundreds of millions of dollars in economic activity for the region. The Bastrop Opera House presented their annual report at the August 28th, 2018 Council meeting.

The proposed Community Support Service Agreement will be utilized for all funding provided by the City in exchange for services to the community. The Opera House agreement outlines specific requirements related to Hotel Occupancy Tax and deliverables specific to their request for funding.

POLICY EXPLANATION:

At the June 21st Joint Workshop with Visit Bastrop, the current and future HOT Policy of the City of Bastrop was discussed in detail. Due to the ongoing development of the Cultural Arts Master Plan, an interim process for the Bastrop Opera House to apply for and receive funds was outlined. That process was to submit a request for funding the City Council and for the City to award funds based on the application. The FY 19 Budget allocated \$92,500, in line with FY 18 funding. The Opera House's request for an additional \$40,000 to fund an executive director position was not awarded due to the anticipated completion of the Cultural Arts Master Plan.

The FY 18 budget emphasized Council's desire to diversify our revenue sources and increase our sales tax base. Over the last 12 months, with the creation of Visit Bastrop, the establishment of the City's Hospitality & Downtown Department, and the ongoing development of our Cultural Arts Master Plan; we are now uniquely positioned to leverage and work in tandem towards our

community goals related to tourism. We hope to continue to effectively market and promote the Bastrop Opera House as part of the overall Bastrop visitor experience. FY 18's funding agreement outlined specific deliverables, as does the proposed FY 19 Community Support Service Agreement.

FUNDING SOURCE:

FY 19 Hotel Occupancy Tax Fund

RECOMMENDATION:

Consider action to approve Resolution No. R-2018-93 of the City Council of the City of Bastrop, Texas awarding a Community Support Service Agreement associated with operating, marketing and providing cultural art and theater services to the Bastrop Opera House, at a cost of ninety Two Thousand and Five-Hundred and 00/100 Dollars (\$92,500) attached as Exhibit A; authorizing the City Manager to execute all necessary documents for the contract; providing for a repealing clause; and establishing an effective date.

ATTACHMENTS:

- Resolution No-2018-93
- DRAFT Community Service Support Agreement
- FY 19 HOT Fund Request submitted by Bastrop Opera House

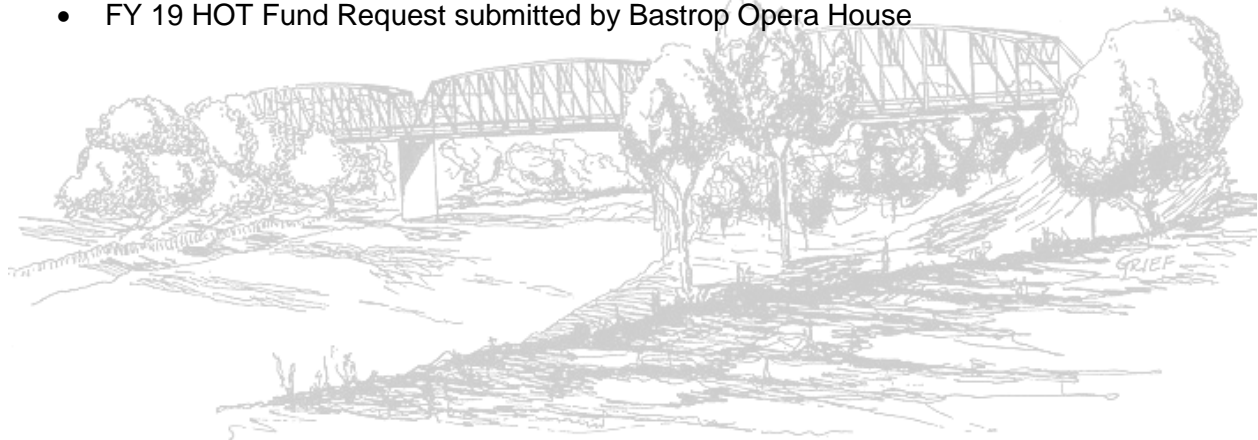

RESOLUTION NO. R-2018-93

A RESOLUTION OF THE CITY COUNCIL OF THE CITY OF BASTROP, TEXAS AWARDED A COMMUNITY SUPPORT SERVICE AGREEMENT FOR SERVICES ASSOCIATED WITH OPERATING, MARKETING, AND PROVIDING CULTURAL ART AND THEATER SERVICES TO THE BASTROP OPERA HOUSE, AT A COST OF NINETY-TWO THOUSAND AND FIVE HUNDRED AND 00/100 DOLLARS (\$92,500), ATTACHED AS EXHIBIT A; AUTHORIZING THE CITY MANAGER TO EXECUTE ALL NECESSARY DOCUMENTS FOR THE CONTRACT; PROVIDING FOR A REPEALING CLAUSE; AND ESTABLISHING AN EFFECTIVE DATE.

WHEREAS, the City Council has appointed the City Manager as the Chief Administrative Officer of the City; and

WHEREAS, the City Manager is responsible for the proper administration of all affairs of the City; and

WHEREAS, the City Council realizes the importance of preserving the Bastrop Opera House and providing theatrical entertainment and education to the Citizens of Bastrop, Texas and our out-of-town visitors; and

WHEREAS, Chapter 351 of the Tax Code provides the requirements on how Hotel Occupancy Tax (HOT) funds may be spent; and

WHEREAS, the City of Bastrop has been working to leverage HOT funds to attract tourism and strengthen our sales tax base by maximizing our return on investment; and

WHEREAS, the Bastrop Opera House is an integral part of the cultural arts fabric of the City

WHEREAS, the Comprehensive Plan also states that Bastrop's continued emphasis on cultural arts and tourism development through coordinated policies will lead to hundreds of millions in economic activity for the region.

NOW, THEREFORE, BE IT RESOLVED BY THE CITY COUNCIL OF THE CITY OF BASTROP, TEXAS:

SECTION 1. That the City Manager is hereby authorized to execute a Community Support Service Agreement associated with services associated with operating, marketing and providing cultural art and theater services, to the Bastrop Opera House, at a cost of Ninety-Two Thousand and Five Hundred and 00/100 Dollars (\$92,500) attached as Exhibit A.

SECTION 2. That the City Council of the City of Bastrop has found that the Bastrop Opera House staff, volunteers, and board of directors are subject matter experts in the field of providing theatrical performances and educational activities to visitors and residents.

SECTION 3. All orders, ordinances, and resolutions, or parts thereof, which are in conflict or inconsistent with any provision of this Resolution are hereby repealed to the extent of such

conflict, and the provisions of this Resolution shall be and remain controlling as to the matters resolved herein.

SECTION 4. That this resolution shall take effect immediately from and after its passage, and it is duly resolved.

DULY RESOLVED AND APPROVED by the City Council of the City of Bastrop this 13th day of November, 2018.

CITY OF BASTROP, TEXAS

Connie B. Schroeder, Mayor

ATTEST:

Ann Franklin, City Secretary

APPROVED AS TO FORM:

Alan Bojorquez, City Attorney



COMMUNITY SERVICES FUNDING AGREEMENT

FY 2018 - 2019

This Community Services Grant Funding Agreement (“Agreement”) is made by and between the **City of Bastrop, Texas**, a Texas home-rule municipal corporation, (“City”), and the Bastrop Opera House, a Texas non-profit corporation (“Organization”). The City and Organization are also referred to collectively in this Agreement as the “Parties” and singularly as a “Party.” The Parties intend that this Agreement will supersede and replace all previously adopted and finalized Agreements in their entirety, if any.

NOW, IN CONSIDERATION of the mutual covenants to be performed by the Parties and other valuable consideration hereby acknowledged, therefore, be it mutually agreed as follows:

1. SCOPE OF SERVICES

A. Proposed & Modified Services Plan. Organization shall utilize the grant funds conveyed herein to provide services to the Bastrop community in accordance with the proposal attached as *Exhibit “A”*, which has been accepted by the City, and as may have been modified in accordance with *Exhibit “B”*.

B. Staffing. Organization shall use its best efforts to secure sufficient numbers of employees and volunteers to accomplish the responsibilities set forth in this Agreement. Organization shall further provide such office space, equipment, supplies and other materials as may be necessary to accomplish the purposes of this Agreement. Organization acknowledges that no personnel engaged by the Organization shall be construed as agents, employees or officers of the City.

C. Nondiscrimination: Organization shall provide services under this Agreement free of discrimination or retaliation due to a person’s race, ethnicity, nationality, religion, gender, gender identity, sexual orientation, religion, parental status, or marital status. Any restrictions on services based on age, physical ability or mental ability shall be directly relevant to legitimate safety concerns in accordance with written Organization policies and procedures.

2. FUNDING

A. Amount. The City shall provide to Organization grant funds in an amount up to a sum not to exceed Ninety-Two Thousand Five Hundred and 00/100 Dollars (\$92,500.00).

B. Disbursals. The City shall remit payment to the Organization of the grant funds due quarterly as an installment.

3. ACCOUNTABILITY

A. Funding Source Identification. Organization shall prominently include the City of Bastrop logo on all educational and marketing materials promoting services covered by this Agreement, including (but not limited to) print items, internet posts, and social media. Such materials will also include the line, "Funding for this program was made possible through a grant from the City of Bastrop."

B. Written Reports. Organization shall submit to the City's Hospitality & Downtown Department written reports on a quarterly basis describing the status of the services provided under this Agreement. Quarterly reports shall be submitted during the months of January, April, July, and October. Reports shall be public records. The first three reports shall be progress reports, and the fourth report shall be an annual summary. The reports shall include (but are not limited to) the following information:

(1) Services: a description of the services provided during the preceding quarter; and

(2) Financial Statement: a financial statement for the reporting period that indicates how the Organization expended grant funds; and

(3) Promotions: copies of promotional materials distributed.

C. Oral Reports. Organization shall attend a regular meeting of the City Council on a quarterly basis to make a public presentation on the services provided under this Agreement. Attendance shall be scheduled in advance with the City's designated staff contact person. Organization shall submit presentation materials (i.e., visual aids) to the City's designated staff contact person at least 96 hours prior to the meeting.

D. Oversight of Expenditures. Organization shall exercise all reasonable, prudent and diligent efforts to ensure the proper and legal oversight, use, and expenditure of the grant funds conveyed under this Agreement. Organization's failure to use the funds in the manner approved by this Agreement shall void and negate the City's obligation to make any further payments to the Organization under the Agreement.

E. Comingling. Organization shall properly segregate grant funds and shall not comingle grant funds with other financial assets of the Organization.

F. Accounting Practices. Organization shall utilize generally accepted bookkeeping and standard accounting practices to maintain complete and accurate financial records of all expenditures of grant funds. Upon the City's request, the Organization shall promptly make the records available for inspection and review at any time during the term of this Agreement.

G. Audit. Organization shall have its records and accounts audited annually and shall prepare an annual financial statement based on the audit. Audits and financial statements shall be prepared by a certified public accountant (CPA) who is licensed in Texas or a public accountant who holds a permit to practice from the Texas State Board of Public Accountancy. Audits and financial statements shall be available to the City upon request, and shall be public records.

H. Records Retention. All reports and records related to grant funds shall be maintained by the Organization and available to the City for a period of at least 3 years of the Effective Date. If there is any dispute regarding these reports or records, the retention period shall be extended in accordance with the City's instructions. To the extent Organization's records regarding services provided under this Agreement are subject to the Texas Public Information Act, Organization agrees to cooperate with any open records requests.

I. Hotel Occupancy Taxes. . Organization shall comply with the requirements in Chapter 351 of the Texas Tax Code in the use of hotel occupancy taxes.

4. GENERAL PROVISIONS

A. Duration. This Agreement shall be in effect for fiscal year 2018-2019, which commences October 1st and ends September 30th, unless earlier terminated as provided herein.

B. Suspension of Payments.

(1) Misappropriation. Organization's failure to use the funds in the manner approved by this Agreement, as specified in Exhibit "A", shall be grounds for the City to suspend the remittance of further payments to the Organization under the Agreement.

(2) Comingling. Organization's failure to properly segregate grant funds shall be grounds for the City to suspend the remittance of further payments to the Organization under the Agreement.

(3) Records. Organization's failure to provide the City with copies of financial records mandated under this Agreement shall be grounds for the City to suspend the remittance of further payments to the Organization under the Agreement.

(4) Reports. Organization's failure to timely submit reports mandated under this Agreement shall be grounds for the City to suspend the remittance of further payments to the Organization under the Agreement.

(5) Notice. Notice of suspension shall be sent by the City to the Organization with an explanation and opportunity for the Organization to cure the infraction within 14 calendar days.

(6) Breach. Failure to remedy the infraction within 14 calendar days shall be grounds for the City to declare the Organization in breach and terminate this Agreement as provided herein.

C. Termination. In the event that the Organization fails to abide by any of the terms of this Agreement, the City may terminate the Agreement and any obligations of the City hereunder, as set forth herein, with absolutely no penalty or claim against the City by the Organization. Notice of termination shall negate the City's obligation to remit a scheduled payment (if any). Upon termination for failure to cure the misappropriation of grant funds, Organization is obligated to reimburse the City for all funds misappropriated by the Organization in violation of this Agreement.

D. Ineligibility for Future Funding. Organization's failure to remedy the infraction upon receipt of notice this Agreement may render the Organization ineligible for future funding by the City.

E. Good Standing. The Organization hereby represents that it is in good standing with the Texas Secretary of State and has no City, County, State, or Federal debts or liens charged against it. Organization shall notify the City of any change in such status within 14 calendar days of Organization's receipt of notification.

F. Future Appropriations. Any future grants by the City are conditioned on appropriations by the City Council. The Parties acknowledge that nothing related to this Agreement or the City's stated desire to support the Organization (generally), at the time of execution of this Agreement, may be inferred to indicate that the City will provide any funds in the future. The Organization acknowledges that funding by the City shall be decided on a fiscal year basis and will be determined by the City Council based upon its evaluation of the City's budget and considering all fiscal needs confronting the City, including needs related to the proposed community services.

G. Notices. Any notice necessary or appropriate relative to this Agreement shall be effective when deposited in the United States mail, either certified and/or registered mail, postage prepaid and addressed as provided herein. Notices to the City shall be sent to the City's designated staff contact person:

City of Bastrop
Attn: Hospitality & Downtown Department
P.O. Box 427
Bastrop, Texas 78602

Notices to the Organization shall be sent in accordance with *Exhibit "C"*.

- H. Assignment.** No part of this Agreement may be assigned or delegated without the prior written consent of the other Party, and any attempted assignment of benefits or rights or delegation of duties or obligations shall constitute breach of this Agreement.
- I. Governing Law & Venue.** This Agreement shall be subject to the laws of the State of Texas and the City of Bastrop, Texas. Venue for any disputes arising under this Agreement shall rest solely in Bastrop County.
- J. Indemnity.** Organization agrees to and shall indemnify and hold harmless and defend the City of Bastrop, Texas, its officers, agents, representatives, consultants, and employees from any and all claims, losses, causes of action and damages, suits, and liability for the gross negligence and willful misconduct of Organization, including all expenses of litigation, court costs, and attorney fees, for injury to or death of any person, or from damage to any property, arising from or in connection with the operations of Organization, or its officers, agents, and employees, carried out in furtherance of this Agreement.
- K. Insurance.** The Organization shall maintain comprehensive general liability insurance policy for its operations. The policy shall name City as an additional insured. The Organization shall also maintain insurance on the Organization's personal property, in an amount determined sufficient by the Organization. The Organization shall deliver copies of the insurance policies specified hereunder to the City within 30 days of the Effective Date.
- L. Inclusiveness:** This document represents the entire understanding between the Parties. This Agreement may only be amended in writing with the mutual consent of the Parties.
- M. Severability:** If any sentence, clause or portion of this Agreement is deemed unenforceable by a court of competent jurisdiction, the remainder of the Agreement shall remain in full force and effect.
- N. Effective Date.** The City and the Organization make and execute this Agreement to be effective upon the _____ day of _____, 2018.

IN WITNESS, WHEREOF:

CITY:

ORGANIZATION:

by: _____
 Lynda Humble, City Manager
 City of Bastrop
 Date of Execution: _____

by: _____
 Executive Director
 Bastrop Opera House
 Date of Execution: _____

ATTEST:

by: _____
Ann Franklin, City Secretary
City of Bastrop

DRAFT

ORGANIZATION'S PROPOSED SERVICES

Bastrop Opera House 2018-2019 Request

Requested HOT funds for the 2018-2019 season will be used for:

- Production expenses
- Advertising/Promoting
- Production Equipment
- Conferences
- Staff

Funds will be used in promoting the art of theatre and encouraging attendance of events for out of town visitors thereby directly growing and advancing cultural tourism and hotel industry.

The Bastrop community will benefit from the Opera House by having high quality performances/shows brought to them. This will bring in both day visitors as well as overnight visitors who will come to Bastrop for the purpose of attending a performance at the Opera House. We receive calls on a regular basis from people out of town who want to come experience a show/event at the Opera House, but also want to know where to stay, eat, etc. while they are in Bastrop.

The Bastrop Opera House is currently the only live community theatre venue in Bastrop. There are other venues in Bastrop that provide live bands. However, the Opera House is the only community venue that provides live theatre as well as the only venue that provides educational and acting opportunities for Bastrop citizens.

Exhibit “B”

CITY’S MODIFIED SERVICES PLAN

Present 9-12 months’ worth of programs annually (January – December) designed to appeal to tourists and attract overnight visitation to City Council.

All art work, images and details regarding the individual programs such as “performances,” “classes,” or “exhibits” for the contract period including ticket prices and purchasing methods must have specific program details received by Visit Bastrop through their online CRM system no later than 90 days in advance, preferably 120 days in advance.

Maintain an active social media and online digital presence including Google, Yelp, Trip Advisor, and similar listings.

Develop an annual marketing plan for the promotion of the arts and activities at the Opera House.

Develop a strategic plan that addresses identifying additional funding sources for sustainability.

Present an annual operating budget to the City.

In partnership with Visit Bastrop, develop an intercept survey of guests to include data such as: where the visitor is from, demographic data, social-economic data, how they discovered Bastrop (advertising, social media, word-of-mouth), lodging information, length of stay, size of party, primary attractor, intent to return.

Maintain and collect monthly year-over-year ticket sales and primary market origin of ticket holders’ data.

Participate in customer service, destination, board development and/or Hotel Occupancy Tax Training as provided by the City or Visit Bastrop.

Work with Visit Bastrop and Explore Bastrop County to create “programming” that would be available for groups and conventions.

Develop and maintain a building rental program and policies allowing opportunities for additional revenue streams and access to the facility to outside users.

Actively participate in the Cultural Arts Master Plan development and implementation process that is yet to be identified.

Any work to be performed on the Bastrop Opera House historic structure utilizing Hotel Occupancy Tax must comply with all regulations: local, state and federal. All work must also comply with the Secretary of the Interior’s standards for rehabilitation. To ensure compliance proposed work must be submitted to the Bastrop Main Street Program prior to work commencing and may require up to 60 days for approval depending on the Texas Historical Commission’s project reviewer’s schedule.

DRAFT

Exhibit "C"

NOTICE TO ORGANIZATION

Notices required under the terms of this Agreement shall be sent to the Organization as follows:

Bastrop Opera House
Attn: Lisa Holcomb
711 Spring Street
Bastrop, Texas 78602

DRAFT

Bastrop Opera House
Hot Funds Application
2018/2019

Hot Funding Report FY 2017-2018 Season– Deliverables

- The Bastrop Opera House created a year long season that was heavily marketed. Our season runs from September-September. In the 2017-2018 season the Opera House produced 8 full productions and brought in 9 touring shows.
- We use Arts People which is an online ticket software for performing arts. This program has powerful tools to help us create targeted communications with our patrons. It also allows us to run off reports showing where all our ticket purchasers are from based on zip codes. This is how we know that over 50% are from outside of Bastrop county.
- Bastrop Opera House hosted several different events throughout the season for the community.
 1. The Bastrop County Best of the Best” awards ceremony was hosted at the Opera House as well as the Small Business Revolution Revealing Party.
 2. The Small Business Revolution Announcement Party was hosted at the OH.
 3. Bastrop hotel sales meeting
 4. Bastrop Film Friendly Workshop
 5. Bastrop County Tourism Rally
 6. Start off place for Christmas Cookie Crawl
- Bastrop Opera House rented the facility throughout the 2017-2018 season
 1. Bastrop County Honor Choir Performance Fundraiser
 2. Heart of Texas Church of Christ
 3. Conor McAnally /Honor Choir Fundraiser
 4. Historical Society Rendezvous
 5. Paxton Carpenter for week long company training
- The Opera House uses Arts People which is an online ticket software for performing arts. This program has powerful tools to help us create targeted reports. It also allows us to run off reports showing where all our ticket purchasers are from based on zip codes. This is how we know that over 50% are from outside of Bastrop county.
 1. Tickets sales for 2017-2018: 3,282 tickets sold online
 2. approximately 958 at the door. At the time of this report, we still have tickets to sell through August for this season.
 3. 1,233 tickets were from Bastrop zip code
- The Opera House is home to the Bastrop Opera House Youth Performing Arts Academy that has approximately 60 youth ages 3- high school enrolled. Each season 2 major youth productions are performed (fall and spring).
- In June of this season the Opera House had its first 2-week long summer musical theatre group that had 16 youth enrolled. This was a very successful camp and will be repeated this next summer.

Bastrop Opera House

711 Spring Street

Bastrop, TX 78602

Lisa Holcomb, Executive Director

Is this organization a 501 (c) 3? YES

Tax Id # 74-2161743

Total Amount Requested: \$132,055

Bastrop Opera House Mission:

The Bastrop Opera House was built in 1889 and is still producing quality entertainment for families. Plays are an ancient form of storytelling. Some are light hearted; some are deep and profound. All offer a message to the audience. Classic and contemporary plays and musicals speak to us because they explore what it means to be human. The Bastrop Opera House strives to give its performers the chance to perform and entertain. To give a gift back to the community in the form of acting.

To watch the Opera House come “alive” this last season has been a thrill for those of us involved with the Opera House. Almost any evening of the week, Monday-Thursday, you can come by and see actors, musicians, techs, all working together to get ready for the next show. Afternoons you’ll find children in the Opera House learning the art of theatre and most weekends you can be entertained with a play, musical or one of the touring shows.

We often have people call from out of town (sometimes out of state) to say that they want to come to Bastrop to see a show and want to know where to stay, eat, etc. We have people from out of town come see a show who say they will be returning to see another show but will stay the whole weekend.

Community theatre is a team effort opportunity for people of all talents, skills and energy . It enriches the community -- financially and artistically. Theatre is a wonderful leveler of people -- background becomes a moot issue. Plumbers work with and act next to bank presidents, children, and occasionally dogs.

- JoAnne Nissen, Retired Vice President, MRA-The Management Association, Racine, WI

Bastrop Opera House 2017-2018 Season

The OH had a fantastic and full season. There was hardly a weekend that didn't have a show/event/live music happening. The season consisted of:

War of the Worlds Radio Show

Rocky Horror Picture Show

The Derailers

Walkin' The Line

Austin Troubadours

Completely Hollywood

Decee Cornish Tribute To Washington Carver

Dona Rosita's Jalapeno Kitchen

E Flat Porch Band

Gospel Music Concert

Kitchen Witches

Flamenco Ensemble

Murder at Rutherford House

The Bible In 30 Minutes... Or Less

The Enchanted Bookshop

The Fantasticks

The Stories of Scheherazade

Clinically Undepressed

Bastrop Opera House 2018-2019 Hot Funds Request

Hot funds for the 2018-2019 season will be used for:

- Production expenses
- Advertising/Promoting
- Production Equipment
- Conferences
- Staff

Funds will be used in promoting the art of theatre and encouraging attendance of events for out of town visitors thereby directly growing and advancing cultural tourism and hotel industry.

The Bastrop community will benefit from the Opera House by having high quality performances/shows brought to them. This will bring in both day visitors as well as overnight visitors who will come to Bastrop for the purpose of attending a performance at the Opera House. We receive calls on a regular basis from people out of town who want to come see a show/event at the Opera House but also want to know where to stay, eat, etc. while they are in Bastrop.

The Bastrop Opera House is currently the only live community theatre venue in Bastrop. There are other venues in Bastrop that provide live bands, however the Opera House is the only community venue that provides live theatre and the only venue that provides educational and acting opportunities for Bastrop citizens.

The new season will consist of:

Walkin' The Line September 7, 8

OZ! The Musical September 14, 15, 21, 22, 28, 29 at 7:30 pm
September 16 at 2:30 pm

The Legend of Sleepy Hollow October 12, 13, 19, 20, 26, 27 at 7:30 pm
October 21 at 2:30 pm

D'Vine Testament November 10, 7:30 pm

Nuncrackers November 30 at 7:30 pm
December 1, 7, 14, 15, at 7:30 pm
December 8 at 2:30 pm
December 9 at 2:30 pm

The Cemetery Club January 11, 12, 18, 19, 25, 26 at 7:30 pm
January 20 at 2:30 pm

Steal Away Home
February 8, 9, 15, 16 at 7:30 pm
February 10 & 17 at 2:30 pm

Gilbert & Sullivan Valentine Dinner Theatre Show
February 14th

Texas Free! Victory or Death (Dinner Theatre) March 2

Guy Forsyth in Concert
March 9th

If You're Irish, Come Into The Parlor March 17

Dracula: The Musical? March 29, 30 at 7:30 pm
April 5, 6, 12, 13 at 7:30 pm
April 7 at 2:30 pm

Bastrop County Bar Association Murder Trial April 26-28

Dearly Beloved May 17, 18, 24, 25, 31 and June 1 at 7:30 pm
May 26 at 2:30 pm

Newsies The Broadway Musical July 12, 13, 19, 20, 26, 27 at 7:30 pm
July 21 at 2:30 pm

Helium August 9, 10, 16, 17, 23, 24 at 7:30 pm
August 18 at 2:30 pm

Hot Funds Proposal Budget

Production Expenses

9 Main productions: \$30,855

8 Touring shows: \$11,000

Advertising/promotions/social media: \$25,200

Production equipment: \$20,000

Total Production Expense: \$87,055

Conferences

\$5000

Bastrop Opera House will participate in the Texas Nonprofit conferences throughout the 2019 season. This promotes both the Opera House as well as Bastrop.

Staff Salary

\$40,000

Current executive director is an unpaid position. The board wants to be able to move this to a paid position for the current executive director. Hot funds will help us to do that until the Opera House can fund that position on their own. The goal for 2019-2020 FY is for the Bastrop Opera House to fund at least 50% of salary and increasing the percentage each year thereafter.

Total: 132,055



STAFF REPORT

MEETING DATE: November 13, 2018

AGENDA ITEM: 9E

TITLE:

Consider action to approve Resolution No. R-2018-93 of the City Council of the City of Bastrop, Texas awarding a Community Support Service Agreement for services associated with operating, marketing and providing museum and visitor center services, to the Bastrop County Historical Society, at a cost of One Hundred and Forty-Six Thousand Nine-Hundred and Thirty-Seven and 00/100 Dollars (\$146,937) attached as Exhibit A; authorizing the City Manager to execute all necessary documents for the contract; providing for a repealing clause; and establishing an effective date.

STAFF REPRESENTATIVE:

Sarah O'Brien, Hospitality & Downtown Director
Tracy Waldron, Chief Financial Officer

BACKGROUND/HISTORY:

Chapter 351 of the Tax Code provides the requirements on how Hotel Occupancy Tax (HOT) funds may be spent. As prioritized in the FY 18 Budget, Staff has been working to leverage HOT funds to attract tourism and strengthen our sales tax base by maximizing our investment. Staff also continues to work to bring HOT fund users together under the strategic goals and vision that have been developed in line with the Council's Focus Areas, the City's 2018 Work Plan, and the Comprehensive Plan 2036.

The Comprehensive Plan also states that Bastrop's continued emphasis on cultural arts and tourism development through coordinated policies will lead to hundreds of millions of dollars in economic activity for the region. The Museum and Visitor Center presented their annual report at the August 28, 2018 Council meeting.

The proposed Community Support Service Agreement will be utilized for all funding provided by the City in exchange for services to the community. The Bastrop County Historical Society agreement outlines specific requirements related to Hotel Occupancy Tax and deliverables specific to their request for funding.

POLICY EXPLANATION:

At the June 21st Joint Workshop with Visit Bastrop, the current and future HOT Policy of the City of Bastrop was discussed in detail. Due to the ongoing development of the Cultural Arts Master Plan, an interim process for the Museum and Visitor Center to apply for and receive funds was outlined. That process was for the Museum and Visitor Center to submit a request for funding to the City Council, who would then award funds based on the application. The FY 19 Budget allocation is \$146,937. The funds will be awarded to the Bastrop County Historical Society separately in line with the different functions that the Museum and Visitor Center play: (1) \$115,000 is being proposed for the operation of the Visitor Center, (2) \$34,893 is being proposed

for historic preservation through the Museum, and (3) \$9,944 is being proposed for the annual Holiday Tour of Homes.

The FY 18 budget emphasized Council's desire to diversify our revenue sources and increase our sales tax base. Over the last 12 months, with the creation of Visit Bastrop, the establishment of the City's Hospitality & Downtown Department, and the ongoing development of our Cultural Arts Master Plan; we are now uniquely positioned to leverage and work in tandem towards our community goals related to tourism. We hope to continue to effectively market and promote the Museum and Visitor's Center as part of the overall Bastrop visitor experience. FY 18's funding agreement outlined specific deliverables, as does the proposed FY 19 Community Support Service Agreement.

FUNDING SOURCE:

FY 19 Hotel Occupancy Tax Fund

RECOMMENDATION:

Consider action to approve Resolution No. R-2018-94 of the City Council of the City of Bastrop, Texas awarding a Community Support Service Agreement associated with operating, marketing and providing cultural art and theater services to the Bastrop County Historical Society, at a cost of One Hundred and Forty-Six Thousand and Nine-Hundred and Thirty-Seven and 00/100 Dollars (\$146,937) attached as Exhibit A; authorizing the City Manager to execute all necessary documents for the contract; providing for a repealing clause; and establishing an effective date.

ATTACHMENTS:

- Resolution No-2018-94
- DRAFT - Community Service Support Agreement
- FY 19 HOT Fund Request submitted by Bastrop County Historical Society



RESOLUTION NO. R-2018-94

A RESOLUTION OF THE CITY COUNCIL OF THE CITY OF BASTROP, TEXAS AWARDED A COMMUNITY SUPPORT SERVICE AGREEMENT FOR SERVICES FOR OPERATING, MARKETING AND STAFFING A HISTORICAL MUSEUM AND VISITOR CENTER AND PROVIDING VISITOR CENTER SERVICES TO THE BASTROP COUNTY HISTORICAL SOCIETY AT A COST OF ONE HUNDRED AND FORTY-SIX THOUSAND NINE-HUNDRED AND THIRTY-SEVEN AND 00/100 DOLLARS (\$146,937) AS ATTACHED AS EXHIBIT A; AUTHORIZING THE CITY MANAGER TO EXECUTE ALL NECESSARY DOCUMENTS FOR THE CONTRACT; PROVIDING FOR A REPEALING CLAUSE AND ESTABLISHING AN EFFECTIVE DATE.

WHEREAS, the City Council has appointed the City Manager as the Chief Administrative Officer of the City; and

WHEREAS, the City Manager is responsible for the proper administration of all affairs of the City; and

WHEREAS, the City Council recognizes the Bastrop County Historical Society as the safe-keeper and story teller of our authentic historic past; and

WHEREAS, the City Council recognizes the Bastrop County Historical Society's staff, volunteers and board members are best equipped to serve as the official visitor information providers and downtown welcome experience experts for all of our visitors; and

WHEREAS, Chapter 351 of the Tax Code provides the requirements on how Hotel Occupancy Tax (HOT) funds may be spent; and

WHEREAS, the City of Bastrop has been working to leverage HOT funds to attract tourism and strengthen our sales tax base by maximizing our return on investment; and

WHEREAS, the Comprehensive Plan 2036 places emphasis on enhancing the visitor experience; and

WHEREAS, the Comprehensive Plan also states that Bastrop's continued emphasis on cultural arts, historic preservation, and tourism development through coordinated policies will lead to hundreds of millions in economic activity for the region; and

NOW, THEREFORE, BE IT RESOLVED BY THE CITY COUNCIL OF THE CITY OF BASTROP, TEXAS:

SECTION 1. That the City Manager is hereby authorized to execute a Community Support Service Agreement associated with services associated with operating, marketing and staffing a historical museum and visitor center and providing visitor center services to the Bastrop County Historical Society, at a cost of One Hundred and Forty-Six Thousand and Nine Hundred and Thirty-Seven and 00/100 Dollars (\$146,937) attached as Exhibit A.

SECTION 2. That the City Council of the City of Bastrop has found that the Bastrop County Historical Society is the leading provider of visitor services, visitor center operations, and historical documentation and story telling of our authentic past.

SECTION 3. All orders, ordinances, and resolutions, or parts thereof, which are in conflict or inconsistent with any provision of this Resolution are hereby repealed to the extent of such conflict, and the provisions of this Resolution shall be and remain controlling as to the matters resolved herein.

SECTION 4. That this resolution shall take effect immediately from and after its passage, and it is duly resolved.

DULY RESOLVED AND APPROVED by the City Council of the City of Bastrop this 13th day of November, 2018.

CITY OF BASTROP, TEXAS

Connie B. Schroeder, Mayor

ATTEST:

Ann Franklin, City Secretary

APPROVED AS TO FORM:

Alan Bojorquez, City Attorney



COMMUNITY SERVICES FUNDING AGREEMENT

FY 2018 - 2019

This Community Services Grant Funding Agreement (“Agreement”) is made by and between the **City of Bastrop, Texas**, a Texas home-rule municipal corporation, (“City”), and Bastrop County Historical Society a Texas non-profit corporation (“Organization”). The City and Organization are also referred to collectively in this Agreement as the “Parties” and singularly as a “Party.” The Parties intend that this Agreement will supersede and replace all previously adopted and finalized Agreements in their entirety, if any.

NOW, IN CONSIDERATION of the mutual covenants to be performed by the Parties and other valuable consideration hereby acknowledged, therefore, be it mutually agreed as follows:

1. SCOPE OF SERVICES

- A. Proposed & Modified Services Plan.** Organization shall utilize the grant funds conveyed herein to provide services to the Bastrop community in accordance with the proposal attached as *Exhibit “A”*, which has been accepted by the City, and as may have been modified in accordance with *Exhibit “B”*.
- B. Staffing.** Organization shall use its best efforts to secure sufficient numbers of employees and volunteers to accomplish the responsibilities set forth in this Agreement. Organization shall further provide such office space, equipment, supplies and other materials as may be necessary to accomplish the purposes of this Agreement. Organization acknowledges that no personnel engaged by the Organization shall be construed as agents, employees or officers of the City.
- C. Nondiscrimination:** Organization shall provide services under this Agreement free of discrimination or retaliation due to a person’s race, ethnicity, nationality, religion, gender, gender identity, sexual orientation, religion, parental status, or marital status. Any restrictions on services based on age, physical ability or mental ability shall be directly relevant to legitimate safety concerns in accordance with written Organization policies and procedures.

2. FUNDING

- A. Amount.** The City shall provide to Organization grant funds in an amount up to a sum not to exceed One Hundred Forty-Six Thousand Nine Hundred and Thirty-Seven and 00/100 Dollars (\$146,937.00).
- B. Disbursements.** The City shall remit payment to the Organization of the grant funds due quarterly as an installment.

3. ACCOUNTABILITY

- A. Funding Source Identification.** Organization shall prominently include the City of Bastrop all educational and marketing materials promoting services covered by this Agreement, including (but not limited to) print items, internet posts, and social media. Such materials will also include the line, "Funding for this program was made possible through a grant from the City of Bastrop."
- B. Written Reports.** Organization shall submit to the Hospitality & Downtown Department written reports on a quarterly basis describing the status of the services provided under this Agreement. Quarterly reports shall be submitted during the months of January, April, July, and October. Reports shall be public records. The first three reports shall be progress reports, and the fourth report shall be an annual summary. The reports shall include (but are not limited to) the following information:
- (1) Services:** a description of the services provided during the preceding quarter; and
 - (2) Financial Statement:** a financial statement for the reporting period that indicates how the Organization expended grant funds; and
 - (3) Promotions:** copies of promotional materials distributed.
- C. Oral Reports.** Organization shall attend a regular meeting of the City Council on a quarterly basis to make a public presentation on the services provided under this Agreement. Attendance shall be scheduled in advance with the City's designated staff contact person. Organization shall submit presentation materials (i.e., visual aids) to the City's designated staff contact person at least 96 hours prior to the meeting.
- D. Oversight of Expenditures.** Organization shall exercise all reasonable, prudent and diligent efforts to ensure the proper and legal oversight, use, and expenditure of the grant funds conveyed under this Agreement. Organization's failure to use the funds in the manner approved by this Agreement shall void and negate the City's obligation to make any further payments to the Organization under the Agreement.
- E. Comingling.** Organization shall properly segregate grant funds and shall not comingle grant funds with other financial assets of the Organization.

G. Notices. Any notice necessary or appropriate relative to this Agreement shall be effective when deposited in the United States mail, either certified and/or registered mail, postage prepaid and addressed as provided herein. Notices to the City shall be sent to the City's designated staff contact person:

City of Bastrop
Attn: Hospitality & Downtown Department
P.O. Box 427
Bastrop, Texas 78602

Notices to the Organization shall be sent in accordance with *Exhibit "C"*.

H. Assignment. No part of this Agreement may be assigned or delegated without the prior written consent of the other Party, and any attempted assignment of benefits or rights or delegation of duties or obligations shall constitute breach of this Agreement.

I. Governing Law & Venue. This Agreement shall be subject to the laws of the State of Texas and the City of Bastrop, Texas. Venue for any disputes arising under this Agreement shall rest solely in Bastrop County.

J. Indemnity. Organization agrees to and shall indemnify and hold harmless and defend the City of Bastrop, Texas, its officers, agents, representatives, consultants, and employees from any and all claims, losses, causes of action and damages, suits, and liability for the gross negligence and willful misconduct of Organization, including all expenses of litigation, court costs, and attorney fees, for injury to or death of any person, or from damage to any property, arising from or in connection with the operations of Organization, or its officers, agents and employees, carried out in furtherance of this Agreement.

K. Insurance. The Organization shall maintain a comprehensive general liability insurance policy for its operations. The policy shall name City as an additional insured. The Organization shall also maintain insurance on the Organization's personal property, in an amount determined sufficient by the Organization. The Organization shall deliver copies of the insurance policies specified hereunder to the City within 30 days of the effective date.

L. Inclusiveness: This document represents the entire understanding between the Parties. This Agreement may only be amended in writing with the mutual consent of the Parties.

M. Severability: If any sentence, clause or portion of this Agreement is deemed unenforceable by a court of competent jurisdiction, the remainder of the Agreement shall remain in full force and effect.

N. Effective Date. The City and the Organization make and execute this Agreement to be effective upon the _____ day of _____, 2018.

IN WITNESS, WHEREOF:

CITY:

by: _____
Lynda Humble, City Manager
City of Bastrop
Date of Execution: _____

ORGANIZATION:

by: _____
Executive Director
Bastrop County Historical Society
Date of Execution: _____

ATTEST:

by: _____
Ann Franklin, City Secretary
City of Bastrop

DRAFT

Exhibit "A"

ORGANIZATION'S PROPOSED SERVICES



**BCHS Museum
HOT Fund Budget FY 2019**

Income from HOT Funds		\$44,837
Allotment for Preservation & Promotion		\$34,893
Archival Equipment	\$670	
Archival Supplies	\$525	
Archivist Speaking Engagements (3)	\$300	
Design & Printing New Brochure	\$2,000	
Exhibits (Temporary & Traveling)	\$3,000	
Permanent Exhibit Maintenance	\$2,000	
Books and other collection material	\$250	
Guest Speakers	\$500	
Continuing Visitor Communication	\$3,000	
Payroll & Taxes	\$21,348	
Postage	\$600	
Signage	\$200	
Website	\$500	
	<u>\$34,893</u>	
Allotment for Tours & Rendezvous Public Gala		\$9,944
(Home Tour/Tour Expenses)		
Advertising Home Tour	\$1,200	
Gift for Homeowners on Tour	\$200	
Home Tour Printing	\$900	
Payroll & Taxes	\$5,544	
Postage	\$300	
Refreshments for VC Day of Tour	\$50	
Rendezvous	\$1,500	
Sponsor Board	\$250	
	<u>\$9,944</u>	

Preservation Budget Detail

Archival Equipment

Laptop	\$250
File Cabinet	\$100
Printer Cartridges	\$100
Envelopes, Packing Tape, Binders	\$50
Document Repair Tape	\$70
Bookcase	\$100
	<hr/>
	\$670

Archival Supplies

Storage Materials

Bankers Boxes	\$100
Archival Clothes Hangar	\$125
Archival File Folders	\$60
Archival Document Sleeves	\$25
Archival Photo Sleeves	\$15
Archival Boxes	\$200
	<hr/>
	\$525

Preservation & Promotion Payroll Detail

Archivist (12 Months - Part time)	\$14,328
Director (12 Months - 1/8 time)	\$7,020
	<hr/>
	\$21,348

Tours Budget Detail

Payroll & Taxes	
Office Manager - 3 Months	\$3,789
1/8 Director - 3 Months	\$1,755
	<hr/>
	\$5,544





BCHS Visitor Center Budget FY 2019

Expenses:

Dedicated Visitor Center Facility

Administration & Office

Four Winds	\$800.00
Computer Equipment & Software	\$1,000.00
Computer Maintenance & Repair	\$1,200.00
Insurance	\$4,000.00
Office Supplies	\$700.00
Telephone	\$1,000.00
Printing	\$800.00
Postage	\$1,050.00

Building Operations (50%)

Building Maintenance (Includes Elevator & AC)	\$3,000.00
Housekeeping	\$3,000.00
Janitorial Supplies	\$300.00
Utilities	\$7,000.00

Payroll & Payroll Taxes (See attachment)	\$68,904.00
--	-------------

Special Events

Housekeeping/Janitorial Service	\$600.00
Payroll & Payroll Taxes	<u>\$1,625.00</u>

Subtotal **\$94,979.00**

Tourism Brochure

Design & Printing	\$3,500.00
Distribution	\$500.00

Marketing & Promotion **\$3,021.00**

Total **\$102,000.00**

Exhibit “B”

CITY’S MODIFIED SERVICES PLAN

Present 9-12 months’ worth of programs annually (January – December) designed to appeal to tourists and attract overnight visitation to City Council.

All art work, images and details regarding the individual programs such as “performances,” “classes,” or “exhibits” for the contract period including ticket prices and purchasing methods must have specific program details received by Visit Bastrop through their online CRM system no later than 90 days in advance, preferably 120 days in advance.

Maintain an active social media and online digital presence.

Develop an Annual Marketing and or strategic plan that addresses identifying additional funding sources for sustainability.

Develop and present an annual operating budget to the City.

Participate in the Bastrop Information Guide Program.

In partnership with Visit Bastrop, develop a visitor intercept survey to include data such as: where the visitor is from, demographic data, social-economic data, how they discovered Bastrop (advertising, social media, word-of-mouth), lodging information, length of stay, size of party, primary attractor, intent to return.

Collect and maintain monthly year-over-year traffic counts and primary market origin data from visitors.

Participate in customer service, destination, board development and/or Hotel Occupancy Tax Training as provided by the City or Visit Bastrop.

Develop and maintain a building rental program and policies allowing opportunities for additional revenue streams and access to the facility to outside users.

Actively participate in the Cultural Arts Master Plan development and implementation process that is yet to be identified.

Follow all applicable local, state and federal laws related to building improvements and expenditures of HOT.

Allow training for volunteers and staff by Visit Bastrop to enhance the visitor experience.

Participate in board training opportunities provide by the Downtown & Hospitality Department designed to strengthen your organization.

Provide volunteer assistance for goodie bag stuffing and distribution to meeting attendees.

Remain open for downtown special events

Provide Step on Guide Services

Assist Visit Bastrop and the Downtown & Hospitality Department with distribution and possible creation of visitor information to be distributed at the Visitor's Center. All materials must contain the City of Bastrop logo.

Work with Visit Bastrop and Explore Bastrop County to create "programming" that would be available for groups and conventions.

8.1.3 of the COMP Plan: Create a visitor's feedback survey with the assistance of Visit Bastrop to better understand the demand for other tourism activities

8.1.3 of the COMP Plan: Increase the number of digital and interactive exhibits and consider offering virtual tours online.

8.1.3 of the COMP Plan. Use interactive media displays that allow people to choose how they interact with the Museum & Visitor Center

8.1.3 of the COMP Plan: Increase social media by posting content online at regular and predictable intervals.

Offer free downtown walking tours on a regular basis. I.E. Every Saturday morning during Preservation Month to better tell the Bastrop story to residents and tourists

Spearhead efforts to develop building markers that tell the story of the historic properties in the downtown district.

Continue to assist with the data population of Downtown, TX.

Provide an annual calendar of events for exhibits, openings, speakers etc. to the Hospitality and Downtown Department and Visit Bastrop January 1st of each year.

Exhibit "C"

NOTICE TO ORGANIZATION

Notices required under the terms of this Agreement shall be sent to the Organization as follows:

Bastrop County Historical Society
Attn: Kaye Spikas
904 Main Street
Bastrop, Texas 78602

DRAFT



HOT Fund Reporting & Application

2018/2019

Table of Contents

FY 2018 HOT Funding Report – Deliverables

FY 2018 Budget vs. Actual – Visitor Center

FY 2018 Budget vs. Actual - Museum

FY 2019 HOT Funding Combined Budget

FY 2019 HOT Fund Budget – Visitor Center

FY 2019 Museum HOT Fund Application

FY 2019 HOT Fund Budget – Museum

BCHS Board of Trustees

HOT Funding Report FY2018

Deliverables

A. Bastrop County Historical Society Museum

- **Offer free downtown walking tours:** BCHS hosted Historic Downtown Walking Tours each Saturday in May for 57 local and out of town individuals. Ken Kesselus, Richard Kesselus, and Mike Helmick served as tour guides for tours that began at the Visitor Center and lasted 45-60 minutes.
- **Continue to assist with the data population of Downtown, TX:** BCHS archivist, Carol Kysar, and volunteers are researching Building Block 7 and anticipate having completed 14-15 reports by the end FY2018 (September 30, 2018).
- **Provide an annual calendar of events:** BCHS did not complete this task by January 1 but did notify DBA and Visit Bastrop well in advance of events. BCHS is working on calendar for 2019.

B. Visitor Center

- **Supply visitor center facility amenities:** The VC prominently displays brochures and maps from 183 locations across the state. In addition, travel guides, maps, and event calendars are provided to the VC by TxDOT. Approximately 20 local and county maps and brochures are available for visitors. The VC is open for First Friday and special downtown events in order to provide restroom facilities for visitors.
- **Provide “goodie bag” services:** 100 brochures and maps were provided to AME Church for their church conference in March. Local brochures and maps were provided for a recent 450+ person conference at the Hyatt. Gift bags were provided for Small Business Revolution representatives. BCHS provides step-on bus tour guides for out-of-town bus tour groups at their request. (See attachment listing tours provided during FY2018.)
- **Allow training of volunteers:** The VC coordinator organized our own training of volunteers at Hyatt Lost Pines and McKinney Roughs. The volunteers will be visiting other attractions in the future.
- **Remain open for downtown special events:** The VC is open for all First Friday Art Walks, Friday Night of Veterans Weekend, Lost Pines Christmas Parade, Sip and Swirl, July 4 festivities, various Pub Crawls, Table on Main.
- **Assist Visit Bastrop with distribution and creation of info to be distributed by Visitor Center:** VC distributes local information and maps for Visit Bastrop and DBA.
- **Work with Visit Bastrop and Explore Bastrop County to create “programming”:** BCHS and the VC offered ½ price admission to the Museum for the Veterans Car Show and Texas Tough Mudders. Free Museum admission was offered to Texas Travel Industry Association meeting participants. A reception was held at the Museum in January for the Small Business Revolution. BCHS and the VC hosted 55 members of the Texas Historical Foundation in April with a docent-led tour of the Museum, presentation of Bastrop history, tour and presentation of Museum archives, tour of David and Libby

Sartain's historic home, and reception for area preservationists. Walking tours of downtown were offered on each Saturday during May and will be offered again in October.

- **Create visitor's feedback survey:** To be determined
- **Use interactive media displays:** Digital informational map is in development stage.
- **Increase social media:** VC has increased Facebook presence.
- **Offer "flash" sales:** Although we did not host a "flash" sale, we did have an end of year gift shop sale
- **Work toward development of a long-range strategic plan:** Current strategic plan expires in 2019. Plans are being made for new one.
- **Volunteer coordinator:** All walking tour, museum docent and step on bus tour curricula has been documented and available for new recruits; orientation & training programs have been developed and processes and procedures put in place to begin building a robust volunteer program to assist in providing additional activities to visitors and residents.

2018 Tours			
Date	Group	Number	Type
Oct. 25	Czech Heritage Society, Sugar Land	15	Step-on & First United Methodist Church
Oct. 26	Calvary 3 rd graders	15	Museum w/scavenger hunt
Nov. 2 CANCELLED Hurricane Harvey	City of West University	18	Step-on & FUMC
Nov. 17	Calvary Episcopal 6 th graders	5	Museum w/scavenger hunt
Dec. 7	Spicewood Art Group	20	Walking tour of downtown
Jan. 3	Little Sheep Learning Center	20	Museum tour
Jan. 25	Bluebonnet Trails Community Group	25	Museum
March 29	Purple Sage Elem. Round Rock	65	Museum
April 10	Spade & Travel Garden Club Gonzales	26	Museum and art center
April 13	Mina 4 th Graders	154	Museum
April 13	Texas Heritage Tours Dallas	37	Step-on & museum
April 13	El Camino Real Board	15-20	Docent led museum tour
April 20	Texas Historical Foundation	60	Step-on, Museum, Ancient Oaks
May 12		15	Downtown Walking Tour
May 14 Cancelled; arrived 90 min. late	Young at Heart/SE Houston	10+	Step-on tour Arrived 12:10
May 15	Pflugerville Parks and Recreation	10	Museum tour
May 17	Mt. Calvary Lutheran Day Trippers, San Antonio	20	Museum Tour
May 17	Mary Peckham Park Seniors	10	Museum Tour
May 19		7	Downtown Walking Tour
May 26		18	Downtown Walking Tour

Bastrop Old Town Visitor Center
Profit & Loss Budget vs. Actual
October 2017 through June 2018

	Oct '17 - Jun 18	Budget	\$ Over Budget	% of Budget
Ordinary Income/Expense				
Income				
Hotel/Motel Tax	86,250.00	0.00	86,250.00	100.0%
Miscellaneous	0.00	0.00	0.00	0.0%
Total Income	86,250.00	0.00	86,250.00	100.0%
Expense				
Advertising	0.00	0.00	0.00	0.0%
Building maintenance				
Air conditioning repair	824.00			
Pest Control	69.00			
Track lights & light heads	584.88			
Building maintenance - Other	1,155.00	3,000.00	-1,845.00	38.5%
Total Building maintenance	2,632.88	3,000.00	-367.12	87.8%
Computer Expenses				
Computer equipment & Software	721.44	1,740.00	-1,018.56	41.5%
Computer repair/service	889.34	1,200.00	-310.66	74.1%
Computer Expenses - Other	0.00	0.00	0.00	0.0%
Total Computer Expenses	1,610.78	2,940.00	-1,329.22	54.8%
Dues & Subscriptions	0.00			
Equipment	0.00	0.00	0.00	0.0%
Four Winds	610.08	800.00	-189.92	76.3%
Insurance	2,049.61	4,000.00	-1,950.39	51.2%
Janitorial Service	2,242.00	3,600.00	-1,358.00	62.3%
Janitorial Supplies	221.54	300.00	-78.46	73.8%
Marketing & Promotion	1,355.45	3,034.00	-1,678.55	44.7%
Misc.	188.14			
Office Supplies	403.29	1,000.00	-596.71	40.3%
Payroll Expenses				
Payroll Taxes	1,486.32			
Payroll Expenses - Other	56,283.97	82,776.00	-26,492.03	68.0%
Total Payroll Expenses	57,770.29	82,776.00	-25,005.71	69.8%
Postage	429.29	500.00	-70.71	85.9%
Printing	480.00	800.00	-320.00	60.0%
Reimbursement	22,708.11			
Signage	18.95			
Tax preparation	325.00	0.00	325.00	100.0%
Telephone	632.72	1,000.00	-367.28	63.3%
Tourism Brochure	0.00	4,000.00	-4,000.00	0.0%
Utilities	3,888.60	7,250.00	-3,361.40	53.6%
Total Expense	97,566.73	115,000.00	-17,433.27	84.8%
Net Ordinary Income	-11,316.73	-115,000.00	103,683.27	9.8%
Net Income	-11,316.73	-115,000.00	103,683.27	9.8%

Profit & Loss Budget vs. Actual

October 2017 through June 2018

	Oct '17 - Jun 18	Budget	\$ Over Budget	% of Budget
Ordinary Income/Expense				
Income				
HOTEL MOTEL TAX	25,158.75	33,545.00	-8,386.25	75.0%
Total Income	25,158.75	33,545.00	-8,386.25	75.0%
Expense				
ADVERTISING	1,200.50	1,200.00	0.50	100.0%
ARCHIVAL SPEAKING ENGAGEMENTS	0.00	300.00	-300.00	0.0%
ARCHIVAL SUPPLIES/SUPPORT				
EQUIPMENT	838.99	780.00	58.99	107.6%
ORAL HISTORY	1,191.26	1,365.00	-173.74	87.3%
SUPPLIES	428.23	920.00	-491.77	46.5%
Total ARCHIVAL SUPPLIES/SUPPORT	2,458.48	3,065.00	-606.52	80.2%
ARCHIVIST PROMOTION	0.00	0.00	0.00	0.0%
BCHS HOT PAYROLL				
Homes Tour	3,763.00	5,645.00	-1,882.00	66.7%
Preservation & Promotion	9,552.00	13,068.00	-3,516.00	73.1%
BCHS HOT PAYROLL - Other	3,077.00			
Total BCHS HOT PAYROLL	16,392.00	18,713.00	-2,321.00	87.6%
CONTIN. VISITOR COMM.	2,221.77	2,267.00	-45.23	98.0%
EXHIBITS - TEMPORARY	1,239.82	2,000.00	-760.18	62.0%
GUEST SPEAKER/QUARTERLY MEETI...	350.27	500.00	-149.73	70.1%
INTERNET	20.76	500.00	-479.24	4.2%
POSTAGE	199.26	600.00	-400.74	33.2%
PRINTING & DESIGN OF BROCHURE	96.00	2,000.00	-1,904.00	4.8%
Refreshments	47.05			
Reimbursement of HOT Funds	2,712.28			
SIGNAGE	0.00	200.00	-200.00	0.0%
TOUR				
Docent Led	40.20			
Homes	824.94			
TOUR - Other	195.00	1,700.00	-1,505.00	11.5%
Total TOUR	1,060.14	1,700.00	-639.86	62.4%
WEBSITE	306.50	500.00	-193.50	61.3%
Total Expense	28,304.83	33,545.00	-5,240.17	84.4%
Net Ordinary Income	-3,146.08	0.00	-3,146.08	100.0%
Net Income	-3,146.08	0.00	-3,146.08	100.0%



**Bastrop County Historical Society
Visitor Center & Museum Combined HOT Budget
FY 2019**

Combined Budgets	2019	2018
Visitor Center	\$102,000	\$115,000
BCHS Preservation & Promotion	\$34,893	\$25,000
BCHS Homes Tour	<u>\$9,944</u>	<u>\$8,545</u>
Total	\$146,837	\$148,545

Overall budget request for 2019 has been reduced.

With funds allocated during 2018 Visitor Center staff focused on putting systems (i.e. robust volunteer program, staff training and policies & procedures) in place to ensure higher efficiency. This has resulted in lower operating cost for the Visitor Center.

In 2019 staff will focus on increasing our Preservation & Promotion efforts. We are requesting an increase in funding in that area which is offset by the savings from the Visitor Center, resulting in an overall savings of \$1,500.



BCHS Visitor Center Budget FY 2019

Expenses:

Dedicated Visitor Center Facility

Administration & Office

Four Winds	\$800.00
Computer Equipment & Software	\$1,000.00
Computer Maintenance & Repair	\$1,200.00
Insurance	\$4,000.00
Office Supplies	\$700.00
Telephone	\$1,000.00
Printing	\$800.00
Postage	\$1,050.00

Building Operations (50%)

Building Maintenance (Includes Elevator & AC)	\$3,000.00
Housekeeping	\$3,000.00
Janitorial Supplies	\$300.00
Utilities	\$7,000.00

Payroll & Payroll Taxes (See attachment) \$68,904.00

Special Events

Housekeeping/Janitorial Service	\$600.00
Payroll & Payroll Taxes	<u>\$1,625.00</u>

Subtotal **\$94,979.00**

Tourism Brochure

Design & Printing	\$3,500.00
Distribution	\$500.00

Marketing & Promotion **\$3,021.00**

Total **\$102,000.00**



Visitor Center Payroll Detail

VC Manager	\$32,400.00
VC Associate Weekend/Special Events	\$8,424.00
Director (50%)	<u>\$28,080.00</u>
Total	\$68,904.00

Bastrop County Historical Society

904 Main Street

Bastrop, TX 78602

512.303.0057

www.bastropcountyhistoricalsociety.com

Kaye Sapikas, Director

Is your organization 501(c)3? Yes

Tax ID# 74-1650053

Total Amount Requested \$43,337.00

Total Amount Granted 2018 \$33,545.00

Provide a brief description of your organization's mission:

History comes alive when someone can visit the places, examine the artifacts, appreciate the images, and study the actual words that came before us. A concerted effort to preserve our heritage is critical to our cultural, educational, aesthetic, inspirational, and economic legacies — all the things that, quite literally, make us who we are.

In 1952 the Bastrop County Historical Society (BCHS) was founded to provide the “concerted effort” of collecting and preserving the materials, artifacts and documents relating to the history of Stephen F. Austin’s Little Colony now known as Bastrop.

The result of these efforts includes a remarkable museum, a state of the art collection of artifacts, insightful presentations and professional video productions that span more than 9 million years – from a prehistoric mastodon skull to half-burned possessions recovered from the devastating 2011 Bastrop Complex Fire.

In addition, BCHS inspires Bastrop’s youth through frequent student tours, coordinates authoritative speaker presentations four times a year, maintains a research library containing over 13, 856 pieces, comprised of 7,058 archives, 1,844 objects, and 4,433 photographs. BCHS also assists in historical site preservation (Fairview Cemetery and Kerr Community Center). All of which add to the experience that residents, residents’ family and friends and tourists enjoy.

Promoting Heritage Tourism:

The Museum and Visitor Center of BCHS is open seven days a week. Our front gallery, with eight ‘state of the art’ exhibits (a timeline from early history to present, El Camino Real de los Tejas, The Colorado River, The Lost Pines, and the Baron de Bastrop) was completed in November 2013. The Settlers Exhibit, our first exhibit in our Maynard Room Galleries, opened in February 2015, quickly followed by the Runaway Scrape Exhibit in May 2015 and the Road to Independence Exhibit debuted in the Summer of 2015.

A successful Capital Campaign was launched during the summer of 2015 to fund the completion of the five remaining exhibits in the Maynard Room Galleries. WW II and Camp Swift opened Memorial Day Weekend 2016. When Cotton Was King opened in February 2017. Governor Joseph Draper Sayers and The Cattle Industry exhibits opened in March 2018 and our final exhibit Coal Mines, including oral interviews with miners and the growth of the Hispanic population in Bastrop County which will open October 2018.

With the opening of our newest exhibits, BCHS updated its museum brochure in Fall 2017 to include photos of those exhibits and will need to update it again in Fall 2018 to include newly added exhibits.

Over the past year BCHS has sponsored three special exhibits –the Ladies Reading Circle, Early Bastrop County Education, and World War II on the Home Front. A fourth special exhibit is planned for later this year.

Through the museum, the society promotes Bastrop history by providing a variety of tours. All are available to local citizens, school children, and tourists. Additional BCHS activities: Main Street Revolution reception, hosted Texas Historical Foundation during their conference at the Hyatt, wine tasting and music during the Music Festival, and walking tours each Saturday in May which will continue with tours each Saturday in October. In addition, BCHS participates in all First Friday Art Walks with free admission to the Museum.

Advertising

BCHS has a website and we have expanded our presence on social media with an ongoing Facebook page, a TripAdvisor page, and various internet listings on tourism related sites.

Our advertising over the past year included and will include the following: banners to advertise the Homes Tour and new exhibits, Houston House and Home magazine, The Bastropian, Elgin Courier, The Guide to Bastrop County, and Bastrop City/County Chamber Map.

Project #1 - Promotion of Museum & Historic Preservation **\$34,893**

How will you measure the impact of your event on area hotel activity? NA

Tell us about your event or project.

In 2018 we purchased recording equipment and collected 12 oral histories which will continue in 2019. These follow the StoryCorp concept. Utilizing volunteers to record and catalog Bastrop's rich and diverse history through conversations with those who remember the events of days gone by. These stories will be preserved for future generations and be used in exhibits created by BCHS for the over 8,000 visitors coming to explore the "most historic small town in Texas."

From October 2017 – June 2018 we have had 66 research requests.

In addition to archival activities our Archivist is continuing our work with the "Imagine the Possibilities" program developed by Bastrop Main Street. She has provided research, complete with cited sources and bibliography on 4 properties and anticipates completing 9 additional properties by September 30. She will continue to work on the remaining 115 during FY2019..

The cost for the part time archivist is approximately \$14,000 a year. In addition to the part time staff member, BCHS archive volunteers provide approximately 950 hours annually.

With the adoption of our newest long-range plan in 2014, our goal is to have a sustainable source of funding so that we can be assured we can continue to maintain our facility, exhibits, and research archives. The total budget for the museum side of our operation is approximately \$130,000, city HOT funds provide about 30% of what we need. The rest is raised through other

sources like garage sales, Homes Tour and Rendezvous, donations, memberships and museum admissions.

Facilities Operations and Maintenance

It should be noted that costs such as utilities, cleaning, insurance and elevator maintenance are shared with the Visitor Center on a prorated basis.

Project #2 – Tours

\$8,444

How will you measure the impact of your event on area hotel activity?

In 2017, over 400 guests attended BCHS's Holiday Homes Tour. Although we tried to collect zip code information, we were unable to do so.

Tell us about your event or project:

The BCHS Museum and Visitor Center gives tours to small and large groups who either schedule a tour or show up unannounced. Throughout the year, we conduct "Step-On" bus tours of the historic district including promotion of local hotels and bed and breakfast inns for groups ranging from 10 to 60 people. The following is a list of 2018 tours to date:

2018 Tours			
Date	Group	Number	Type
Oct. 25	Czech Heritage Society, Sugar Land	15	Step-on & First United Methodist Church
Oct. 26	Calvary 3 rd graders	15	Museum w/scavenger hunt
Nov. 2 CANCELLED Hurricane Harvey	City of West University	18	Step-on & FUMC
Nov. 17	Calvary Episcopal 6 th graders	5	Museum w/scavenger hunt
Dec. 7	Spicewood Art Group	20	Walking tour of downtown
Jan. 3	Little Sheep Learning Center	20	Museum tour
Jan. 25	Bluebonnet Trails Community Group	25	Museum
March 29	Purple Sage Elem. Round Rock	65	Museum
April 10	Spade & Travel Garden Club Gonzales	26	Museum and art center
April 13	Mina 4 th Graders	154	Museum
April 13	Texas Heritage Tours Dallas	37	Step-on & museum
April 13	El Camino Real Board	15-20	Docent led museum tour
April 20	Texas Historical Foundation	60	Step-on, Museum, Ancient Oaks
May 12		15	Downtown Walking Tour
May 14 Cancelled; arrived 90 min. late	Young at Heart/SE Houston	10+	Step-on tour Arrived 12:10
May 15	Pflugerville Parks and Recreation	10	Museum tour
May 17	Mt. Calvary Lutheran Day Trippers, San Antonio	20	Museum Tour
May 17	Mary Peckham Park Seniors	10	Museum Tour
May 19		7	Downtown Walking Tour
May 26		18	Downtown Walking Tour

Finally, BCHS's annual Holiday Homes Tour attracts local citizens and tourists to Bastrop. Historical research, tickets, news articles, signage, postage, a special website, paid staff, and more than 90 volunteers work together to promote Bastrop's history through our historic homes. On the day of the event alone, over 500 volunteer hours are logged. BCHS started this event in 1965 with its "Pilgrimage of Homes." Over the years many other local groups have added their own events and activities for that weekend, with the Holiday Homes Tour thus becoming the anchor for Christmas in the Lost Pines.

During 2018 curriculum for downtown walking tours, docent-led museum tours, and step-on bus tours was developed which will allow us to increase our volunteer pool of qualified tour guides. And allowing us to promote this feature more aggressively in the second half of 2019.



BCHS Museum HOT Fund Budget FY 2019

Income from HOT Funds **\$44,837**

Allotment for Preservation & Promotion **\$34,893**

Archival Equipment	\$670
Archival Supplies	\$525
Archivist Speaking Engagements (3)	\$300
Design & Printing New Brochure	\$2,000
Exhibits (Temporary & Traveling)	\$3,000
Permanent Exhibit Maintenance	\$2,000
Books and other collection material	\$250
Guest Speakers	\$500
Continuing Visitor Communication	\$3,000
Payroll & Taxes	\$21,348
Postage	\$600
Signage	\$200
Website	\$500
	<hr/>
	\$34,893

Allotment for Tours & Rendezvous Public Gala **\$9,944**

(Home Tour/Tour Expenses)	
Advertising Home Tour	\$1,200
Gift for Homeowners on Tour	\$200
Home Tour Printing	\$900
Payroll & Taxes	\$5,544
Postage	\$300
Refreshments for VC Day of Tour	\$50
Rendezvous	\$1,500
Sponsor Board	\$250
	<hr/>
	\$9,944



Preservation Budget Detail

Archival Equipment

Laptop	\$250
File Cabinet	\$100
Printer Cartridges	\$100
Envelopes, Packing Tape, Binders	\$50
Document Repair Tape	\$70
Bookcase	\$100
	<hr/>
	\$670

Archival Supplies

Storage Materials

Bankers Boxes	\$100
Archival Clothes Hangar	\$125
Archival File Folders	\$60
Archival Document Sleeves	\$25
Archival Photo Sleeves	\$15
Archival Boxes	\$200
	<hr/>
	\$525

Preservation & Promotion Payroll Detail

Archivist (12 Months - Part time)	\$14,328
Director (12 Months - 1/8 time)	\$7,020
	<hr/>
	\$21,348

Tours Budget Detail

Payroll & Taxes	
Office Manager - 3 Months	\$3,789
1/8 Director - 3 Months	\$1,755
	<hr/>
	\$5,544

BASTROP COUNTY HISTORICAL SOCIETY

904 MAIN STREET
BASTROP, TEXAS 78602
(512) 303-0057

2018 BCHS Trustees

Trustees

Lee Ann Calaway	512-659-4558	Term expires 2020	2008
Sandra Chipley	512-963-8265	Term expires 2020	2010
Barbara Clemons	512-988-8033	Term expires 2020	2014
Dan Hays-Clark	512-303-7701	Term expires 2020	2011
Michal Hubbard	512-517-1416	Term expires 2020	2018
Doris Kershaw	512-321-2104	Term expires 2020	2014
Susan Wendel	512-284-4107	Term expires 2020	2018
Jane Wright	512-844-8243	Term expires 2020	2011
Betty Dunkerley	512-750-9215	Term expires 2020	2010
Sharah Johnson	512-284-4624	Term expires 2019	2015
Jennifer Leisure	512-922-1281	Term expires 2019	2017
Mary McMurrey	512-922-1607	Term expires 2019	2006
Joe Grady Tuck	512-925-2703	Term expires 2019	2017
Glenda Dayton	512-718-1102	Term expires 2019	2016
Jim Lewis	512-296-0883	Term expires 2019	2016

Our Mission:

To preserve and promote the history of Bastrop County



STAFF REPORT

MEETING DATE: November 13, 2018

AGENDA ITEM: 9F

TITLE:

Consider action to approve Resolution No. R-2018-95 of the City Council of the City of Bastrop, Texas awarding a Community Support Service Agreement associated with providing recreation and pool services, to the YMCA of Austin/Bastrop Branch, at a cost of Seventy-Nine Thousand and Eight Hundred and 00/100 Dollars (\$79,800) attached as Exhibit A; authorizing the City Manager to execute all necessary documents for the contract; providing for a repealing clause; and establishing an effective date.

STAFF REPRESENTATIVE:

Sarah O'Brien, Hospitality & Downtown Director

BACKGROUND/HISTORY:

This agreement represents a consolidation of funding and contractual agreements for both recreation services and maintaining and operating the State Park Pool. The Bastrop YMCA has provided these services to the community for several years.

POLICY EXPLANATION:

Pursuant to Chapter 331.001(a) of the Local Government Code, the City of Bastrop is granted authority to make park land and for providing recreational opportunities.

FUNDING SOURCE:

FY 19 Hospitality & Downtown Budget

RECOMMENDATION:

Consider action to approve Resolution No. R-2018-95 of the City Council of the City of Bastrop, Texas awarding a Community Support Service Agreement associated with providing recreation and pool services, to the YMCA of Austin/Bastrop Branch, at a cost of Seventy-Nine Thousand and Eight Hundred and 00/100 Dollars (\$79,800) attached as Exhibit A; authorizing the City Manager to execute all necessary documents for the contract; providing for a repealing clause; and establishing an effective date.

ATTACHMENTS:

- Resolution No-2018-95
- DRAFT - Community Support Service Agreement

RESOLUTION NO. R-2018-95

A RESOLUTION OF THE CITY COUNCIL OF THE CITY OF BASTROP, TEXAS AWARDED A COMMUNITY SUPPORT SERVICE AGREEMENT ASSOCIATED WITH PROVIDING RECREATION AND POOL SERVICES TO THE YMCA OF AUSTIN/BASTROP BRANCH AT A COST OF SEVENTY-NINE THOUSAND AND EIGHT HUNDRED AND 00/100 DOLLARS (\$79,800), ATTACHED AS EXHIBIT A; AUTHORIZING THE CITY MANAGER TO EXECUTE ALL NECESSARY DOCUMENTS FOR THE CONTRACT; PROVIDING FOR A REPEALING CLAUSE, AND ESTABLISHING AN EFFECTIVE DATE.

WHEREAS, the City Council has appointed the City Manager as the Chief Administrative Officer of the City; and

WHEREAS, the City Manager is responsible for the proper administration of all affairs of the City; and

WHEREAS, the City Council realizes the importance of providing recreational activities to the Citizens of Bastrop, Texas; and

WHEREAS, the City Council values the partnership between the Bastrop YMCA and the City of Bastrop; and

WHEREAS, the City Council recognizes and values the Bastrop YMCA operating and managing the Bastrop State Park Pool so that citizens may learn important life skills; and

WHEREAS, the City Council is providing funding through the Hospitality and Downtown Department for services to the community to the Bastrop YMCA; and

WHEREAS, the City of Bastrop's former Recreation Services program and staff will be focusing efforts on providing better customer service to our citizens and the YMCA will provide additional recreation activities on our behalf.

NOW, THEREFORE, BE IT RESOLVED BY THE CITY COUNCIL OF THE CITY OF BASTROP, TEXAS:

SECTION 1: That the City Manager is hereby authorized to execute a Community Support Service Agreement associated with providing recreation and pool services, to the YMCA of Austin/Bastrop Branch, at a cost of Seventy-Nine Thousand and Eight-Hundred and 00/100 Dollars (\$79,800), attached as Exhibit A.

SECTION 2: That the City Council of the City of Bastrop has found that the YMCA of Austin – Bastrop Branch, is a subject matter expert in the field of providing recreational activities to the public.

SECTION 3: All orders, ordinances, and resolutions, or parts thereof, which are in conflict or inconsistent with any provision of this Resolution are hereby repealed to the extent of such conflict, and the provisions of this Resolution shall be and remain controlling as to the matters resolved herein.

SECTION 4. That this resolution shall take effect immediately from and after its passage, and it is duly resolved.

DULY RESOLVED AND APPROVED by the City Council of the City of Bastrop this 13th day of November, 2018.

CITY OF BASTROP, TEXAS

Connie B. Schroeder, Mayor

ATTEST:

Ann Franklin, City Secretary

APPROVED AS TO FORM:

Alan Bojorquez, City Attorney



COMMUNITY SERVICES FUNDING AGREEMENT FY 2018 - 2019

This Community Services Grant Funding Agreement (“Agreement”) is made by and between the **City of Bastrop, Texas**, a Texas home-rule municipal corporation, (“City”), and YMCA of Austin/Bastrop Branch, a Texas non-profit corporation (“Organization”). The City and Organization are also referred to collectively in this Agreement as the “Parties” and singularly as a “Party.” The Parties intend that this Agreement will supersede and replace all previously adopted and finalized Agreements in their entirety, if any.

NOW, IN CONSIDERATION of the mutual covenants to be performed by the Parties and other valuable consideration hereby acknowledged, therefore, be it mutually agreed as follows:

1. SCOPE OF SERVICES

- A. Proposed & Modified Services Plan.** Organization shall utilize the grant funds conveyed herein to provide services to the Bastrop community in accordance with the proposal attached as *Exhibit “A”*, which has been accepted by the City, and as may have been modified in accordance with *Exhibit “B”*.
- B. Staffing.** Organization shall use its best efforts to secure sufficient numbers of employees and volunteers to accomplish the responsibilities set forth in this Agreement. Organization shall further provide such office space, equipment, supplies and other materials as may be necessary to accomplish the purposes of this Agreement. Organization acknowledges that no personnel engaged by the Organization shall be construed as agents, employees or officers of the City.
- C. Nondiscrimination:** Organization shall provide services under this Agreement free of discrimination or retaliation due to a person’s race, ethnicity, nationality, religion, gender, gender identity, sexual orientation, religion, parental status, or marital status. Any restrictions on services based on age, physical ability or mental ability shall be directly relevant to legitimate safety concerns in accordance with written Organization policies and procedures.

2. FUNDING

- A. Amount.** The City shall provide to Organization grant funds in an amount up to a sum not to exceed Seventy-Nine Thousand, Eight Hundred and 00/100 Dollars (\$79,800.00).
- B. Disbursals.** The City shall remit payment to the Organization of the grant funds due quarterly as an installment.

3. ACCOUNTABILITY

- A. Funding Source Identification.** Organization shall prominently include the City of Bastrop and Bastrop Power & Light logo, when applicable all educational and marketing materials promoting services covered by this Agreement, including (but not limited to) print items, internet posts, and social media.
- B. Written Reports.** Organization shall submit to the City's Hospitality & Downtown Department written reports on a quarterly basis describing the status of the services provided under this Agreement. Quarterly reports shall be submitted during the months of January, April, July, and October Reports shall be public records. The first three reports shall be progress reports, and the fourth report shall be an annual summary. The reports shall include (but are not limited to) the following information:
- (1) Services:** a description of the services provided during the preceding quarter; and
 - (2) Financial Statement:** a financial statement for the reporting period that indicates how the Organization expended grant funds; and
 - (3) Promotions:** copies of promotional materials distributed.
- C. Oral Reports.** Organization shall attend a regular meeting of the City Council on a quarterly basis to make a public presentation on the services provided under this Agreement. Attendance shall be scheduled in advance with the City's designated staff contact person. Organization shall submit presentation materials (i.e., visual aids) to the City's designated staff contact person at least 96 hours prior to the meeting.
- D. Oversight of Expenditures.** Organization shall exercise all reasonable, prudent and diligent efforts to ensure the proper and legal oversight, use, and expenditure of the grant funds conveyed under this Agreement. Organization's failure to use the funds in the manner approved by this Agreement shall void and negate the City's obligation to make any further payments to the Organization under the Agreement.
- E. Accounting Practices.** Organization shall utilize generally accepted bookkeeping and standard accounting practices to maintain complete and accurate financial records of all expenditures of grant funds. Upon the City's request, the Organization

shall promptly make the records available for inspection and review at any time during the term of this Agreement.

- F. Overhead.** A portion of the grant funds conveyed to the Organization by this Agreement may be spent by Organization for overhead, that being day-to-day operations, including supplies, administrative salaries, office rental, travel expenses, and other administrative costs, if same have been previously approved in the budget and if directly related to the provision of services approved by this Agreement. The amount of grant funding apportioned for Organization's overhead may not exceed 30% of the total grant amount.
- G. Audit.** Organization shall have its records and accounts audited annually and shall prepare an annual financial statement based on the audit. Audits and financial statements shall be prepared by a certified public accountant (CPA) who is licensed in Texas or a public accountant who holds a permit to practice from the Texas State Board of Public Accountancy. Audits and financial statements shall be available to the City upon request and shall be public records.
- H. Records Retention.** All reports and records related to grant funds shall be maintained by the Organization and available to the City for a period of at least 3 years of the Effective Date. If there is any dispute regarding these reports or records, the retention period shall be extended in accordance with the City's instructions. To the extent Organization's records regarding services provided under this Agreement are subject to the Texas Public Information Act, Organization agrees to cooperate with any open records requests.

4. GENERAL PROVISIONS

- A. Duration.** This Agreement shall be in effect for fiscal year 2018-2019, which commences October 1st and ends September 30th, unless earlier terminated as provided herein.
- B. Suspension of Payments.**
- (1) Misappropriation.** Organization's failure to use the funds in the manner approved by this Agreement, as specified in Exhibit "A", shall be grounds for the City to suspend the remittance of further payments to the Organization under the Agreement.
 - (2) Records.** Organization's failure to provide the City with copies of financial records mandated under this Agreement shall be grounds for the City to suspend the remittance of further payments to the Organization under the Agreement.
 - (3) Reports.** Organization's failure to timely submit reports mandated under this Agreement shall be grounds for the City to suspend the remittance of further payments to the Organization under the Agreement.

(4) Notice. Notice of suspension shall be sent by the City to the Organization with an explanation and opportunity for the Organization to cure the infraction within days.

(5) Breach. Failure to remedy the infraction within 30 days shall be grounds for the City to declare the Organization in breach and terminate this Agreement as provided herein.

C. Termination. In the event that the Organization fails to abide by any of the terms of this Agreement, the City may terminate the Agreement and any obligations of the City hereunder, as set forth herein, with absolutely no penalty or claim against the City by the Organization. Notice of termination shall negate the City's obligation to remit a scheduled payment (if any). Upon termination for failure to cure the misappropriation of grant funds, Organization is obligated to reimburse the City for all funds misappropriated by the Organization in violation of this Agreement.

D. Ineligibility for Future Funding. Organization's failure to remedy the infraction upon receipt of notice this Agreement may render the Organization ineligible for future funding by the City.

E. Good Standing. The Organization hereby represents that it is in good standing with the Texas Secretary of State and has no City, County, State, or Federal debts or liens charged against it. Organization shall notify the City of any change in such status within 30 days of Organization's receipt of notification.

F. Future Appropriations. Any future grants by the City are conditioned on appropriations by the City Council. The Parties acknowledge that nothing related to this Agreement or the City's stated desire to support the Organization (generally), at the time of execution of this Agreement, may be inferred to indicate that the City will provide any funds in the future. The Organization acknowledges that funding by the City shall be decided on a fiscal year basis and will be determined by the City Council based upon its evaluation of the City's budget and considering all fiscal needs confronting the City, including needs related to the proposed community services.

G. Notices. Any notice necessary or appropriate relative to this Agreement shall be effective when deposited in the United States mail, either certified and/or registered mail, postage prepaid and addressed as provided herein. Notices to the City shall be sent to the City's designated staff contact person:

City of Bastrop
Attn: Hospitality & Downtown Department
P.O. Box 427
Bastrop, Texas 78602

Notices to the Organization shall be sent in accordance with *Exhibit "C"*.

- H. Assignment.** No part of this Agreement may be assigned or delegated without the prior written consent of the other Party, and any attempted assignment of benefits or rights or delegation of duties or obligations shall constitute breach of this Agreement.
- I. Governing Law & Venue.** This Agreement shall be subject to the laws of the State of Texas and the City of Bastrop, Texas. Venue for any disputes arising under this Agreement shall rest solely in Bastrop County.
- J. Indemnity.** Organization agrees to and shall indemnify and hold harmless and defend the City of Bastrop, Texas, its officers, agents, representatives, consultants, and employees from any and all claims, losses, causes of action and damages, suits, and liability for the gross negligence and willful misconduct of Organization, including all expenses of litigation, court costs, and attorney fees, for injury to or death of any person, or from damage to any property, arising from or in connection with the operations of Organization, or its officers, agents, and employees, carried out in furtherance of this Agreement.
- K. Insurance.** The Organization shall maintain comprehensive general liability insurance policy for its operations. The policy shall name City as an additional insured. The Organization shall also maintain insurance on the Organization's personal property, in an amount determined sufficient by the Organization. The Organization shall deliver copies of the insurance policies specified hereunder to the City within 30 days of the Effective Date.
- L. Inclusiveness:** This document represents the entire understanding between the Parties. This Agreement may only be amended in writing with the mutual consent of the Parties.
- M. Severability:** If any sentence, clause or portion of this Agreement is deemed unenforceable by a court of competent jurisdiction, the remainder of the Agreement shall remain in full force and effect.
- N. Effective Date.** The City and the Organization make and execute this Agreement to be effective upon the _____ day of _____, 2018.

IN WITNESS, WHEREOF:

CITY:

ORGANIZATION:

by: _____
Lynda Humble, City Manager
City of Bastrop
Date of Execution: _____

by: _____
Executive Director
Bastrop YMCA
Date of Execution: _____

ATTEST:

by: _____
Ann Franklin, City Secretary
City of Bastrop

DRAFT

Exhibit “A”

ORGANIZATION’S PROPOSED SERVICES

The Bastrop YMCA shall provide quality recreational programs for the community in partnership with the City of Bastrop. The City understands the annual contribution given to the YMCA in this agreement as designated in the budget approved by the Bastrop City Council supports a much broader operating budget and other funding sources. Any major changes in recreation program service or special events should be brought to the City’s attention as soon as feasible, however the City of Bastrop doesn’t dictate what the YMCA does or doesn’t do. Any recreation needs identified by the City of Bastrop should be communicated to the YMCA so that their professional staff can evaluate and provide reporting back to the City on the feasibility of meeting those needs.

Programs and activities should be designed to benefit and include persons of all backgrounds. Recognizing the YMCA is a membership organization, financial assistance is available to ensure programming is available to all. These programs should include but are not limited to:

- Minimum of 6 youth sports seasons such as soccer, tennis and volleyball.
- Various enrichment programs monthly, such as art, Youth & Government, nutrition
- Weekly Health & Wellness programs for all ages.
- Operate and manage the State Park Pool with aquatic activities including swim lessons, water fitness, open and public swim and youth job opportunities.

Free events like:

- Family park events, including but not limited to Safety Month, Field days, Halloween Bash, Happy Healthy New Year’s Bash and Movies in the Park.
- Outreach programs such as summer programming, Pickleball, teen events, active older adult programs and more.

Exhibit "B"

CITY'S MODIFIED SERVICES PLAN

Recreation services and program should annually be presented to City Council and should be designed to meet the needs of the Bastrop community.

Maintain an active social media and online digital presence. Maintain an up to date website, social media presence, google, yelp and similar listings online. Submit quarterly calendars.

Develop or maintain a program user intercept survey to include data such as: how they discovered the YMCA.

Track year-over-year participant counts, by program when possible.

Participate in trainings, planning and engagement events related to Parks, Recreation, Community Services, Special Events, Cultural Arts etc. hosted by the City or its partners.

There shall be no charge for the use of the City of Bastrop Parks System, however the YMCA must follow all rental and use policies and timelines set by the City.

The City reserves the right to charge the YMCA as determined by the City Manager or their designee for other services. Those service costs may include Special event permit and support costs, Rental fees at City facilities other than City Parks, and labor costs to support special events that do not serve a need identified by the City of Bastrop.

The YMCA shall schedule park usage thirty (30) days prior to the first practice or scheduled league game. Special Event permit applications must be submitted according to the timelines established wherein. Rental agreements must be made according to any established rental policies.

The YMCA shall list the City of Bastrop as a partner on all advertising for programs or events in the city parks or facilities i.e. flyers, banners, websites and other promotional items.

The YMCA agrees to manage and operate the Facility, State Park Pool, for the benefit of the public, including Bastrop citizens and visitors, through the provision of programs and services that include: open recreation, aquatic exercise, lap swimming, swimming instruction, group rentals, and water safety courses.

The YMCA shall submit to the City a copy of the annual report presented by the YMCA to the TPWD for operating the State Park Pool.

The YMCA shall submit to the City a copy of the annual recreation report generated for the benefit of the Bastrop City Council, staff and citizens prior to funding being allocated for the next FY.

DRAFT

Exhibit "C"

NOTICE TO ORGANIZATION

Notices required under the terms of this Agreement shall be sent to the Organization as follows:

Bastrop YMCA
Attn: Terry Moore
1112 Main Street
Bastrop, Texas 78602

DRAFT



STAFF REPORT

MEETING DATE: November 13, 2018

AGENDA ITEM: 9G

TITLE:

Consider action to approve Resolution No. R-2018-109 of the City Council of the City of Bastrop, Texas, approving a Site Agreement Lease for Air Quality Monitoring with the Capital Area Council of Governments (CAPCOG) for a portion of property in the City's Mayfest Park, located at 25 American Legion Drive, for a term of five (5) years at a total rent of One and 00/100 Dollar (\$1.00); attached as Exhibit A; authorizing City Manager to execute all appropriate documentation; providing for a repealing clause; and establishing an effective date.

STAFF REPRESENTATIVE:

Trey Job, Managing Director of Public Works and Leisure Services

BACKGROUND/HISTORY:

The Austin-Round Rock Metropolitan Statistical Area (MSA), which consists of Bastrop, Caldwell, Hays, Travis, and Williamson Counties, has air pollution levels that are close to violating the federal standards for ground-level ozone (O₃). The U.S. Environmental Protection Agency (EPA) sets federal air quality standards at levels it considers necessary to protect human health and public welfare from harm. The Austin-Round Rock MSA's continued compliance with federal air quality standards is important to ensure public health, protect economic growth, and address the region's transportation needs. The Austin-Round Rock MSA's air pollution regularly reaches levels that the EPA considers "moderate" or "unhealthy for sensitive groups" based on its air quality index (AQI).

On July 25, 2017, City Council approved Resolution R-2017-51, which authorized the City Manager to execute an Interlocal Agreement with CAPCOG for continuation and support of the CAPCOG Regional Air Quality Program. At that time, the Central Texas Regional Air Quality Program was in jeopardy due to the Governor's line item veto of the 2018-2019 "near nonattainment" area grant funding in the state budget. Central Texas has relied on this state funding for the last twenty years to support a successful and nationally acclaimed regional air quality program. The City has contributed to this program in both FY 2017 and FY 2018.

On September 25, 2018, City Council approved Resolution R-2018-99, formally authorizing the City of Bastrop to participate in a new regional air quality plan for 2019-2023. The goals of the new regional air quality plan are to: 1) maximize the probability of compliance with federal air quality standards, and 2) minimize health and environmental impacts associated with regional air pollution. Controlling and reducing emissions of nitrogen oxides (NO_x) and improving public awareness about air quality are critical to supporting the goals of the new regional air quality plan.

POLICY EXPLANATION:

Continuing CAPCOG's air quality program through 2018 is important to ensure that the region remains in compliance with federal standards, and to ensure that we continue to collect and

analyze irreplaceable air quality monitoring data. The program includes eight air quality monitoring stations in addition to the two stations maintained by the EPA, Environmental Protection Agency. Without the Air Quality Program, the Austin MSA could be declared a nonattainment area which would lead to increased costs for industry, permitting delays, restrictions on industry expansion in the area as well as increased costs for businesses and consumers, and loss of federal highway and transit funding

Recently the City and Bastrop County were approached by the Capital Area Council of Governments (CAPCOG) to determine a site to relocate an air quality monitor close to population centers. An air quality monitor is currently located in McKinney Roughs, but needs to be moved to a more populated area and away from trees, which can interfere with the ozone measurements. Several locations were researched, and Mayfest Park was selected due to its location, accessibility, and readily available utilities. This lease will allow the air quality monitor to be located in Mayfest Park for a period of five (5) years, expiring in 2023, for a total cost of One Dollar (\$1.00).

FUNDING SOURCE:

The lease has a direct cost of approximately thirty dollars a month for electricity

RECOMMENDATION:

Consider action to approve Resolution No. R-2018-109 of the City Council of the City of Bastrop, Texas, approving a Site Agreement Lease for Air Quality Monitoring with the Capital Area Council of Governments (CAPCOG) for a portion of property in the City's Mayfest Park, located at 25 American Legion Drive, for a term of five (5) years at a total rent of One and 00/100 Dollar (\$1.00); attached as Exhibit A; authorizing City Manager to execute all appropriate documentation; providing for a repealing clause; and establishing an effective date.

ATTACHMENTS:

- Resolution
- Lease of Site for Air Quality Monitoring

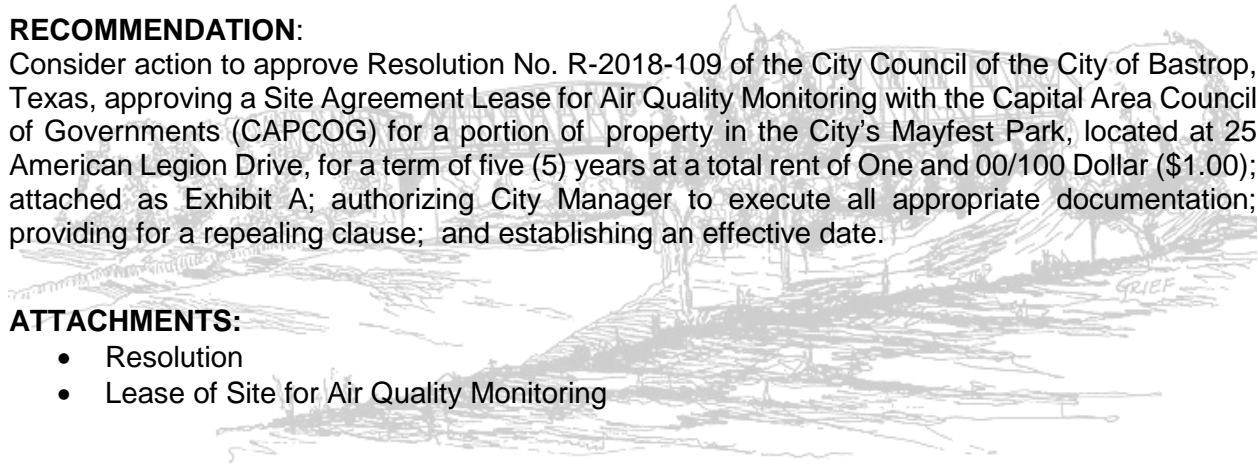

RESOLUTION R-2018-109

A RESOLUTION OF THE CITY COUNCIL OF BASTROP APPROVING A SITE AGREEMENT LEASE FOR AIR QUALITY MONITORING WITH THE CAPITAL AREA COUNCIL OF GOVERNMENTS (CAPCOG) FOR A PORTION OF PROPERTY IN THE CITY'S MAYFEST PARK, LOCATED AT 25 AMERICAN LEGION DRIVE, FOR A TERM OF FIVE (5) YEARS FOR A TOTAL RENT OF \$1.00 (ONE DOLLAR); AS ATTACHED IN EXHIBIT A; AUTHORIZING CITY MANAGER TO EXECUTE ALL APPROPRIATE DOCUMENTATION; PROVIDING FOR A REPEALING CLAUSE; AND ESTABLISHING AN EFFECTIVE DATE.

WHEREAS, the Central Texas Clean Air Coalition (CAC), of which the City of Bastrop is a member, is charged with the development and implementation of a clean air plan to maintain compliance with federal air quality standards and the development of policies and strategies to guide CAC members about actions that will achieve clean air in Texas; and

WHEREAS, the CAC has requested that the City of Bastrop take action to formally participate in a new regional air quality plan for 2019-2023; and

WHEREAS, the Capital Area Council of Governments (CAPCOG) approached the City of Bastrop and Bastrop County to relocate an air quality monitor near a center of population; and

WHEREAS, CAPCOG currently has an air quality monitor located in McKinney Roughs that needs to closer to a more populated area and away from trees, which can interfere with ozone measurements; and

WHEREAS, the City and Bastrop County researched several locations in conjunction with CAPCOG, and Mayfest Park was selected due to its location, accessibility, and readily available utilities; and

WHEREAS, controlling and reducing emissions of nitrogen oxides (NO_x) and improving public awareness about air quality are critical to supporting the goals of the new regional air quality plan; and

WHEREAS, participating with CAPCOG on this project continues the policy, previously set by City Council, to assist other local governmental entities with projects that are mutually beneficial.

NOW, THEREFORE, BE IT RESOLVED BY THE CITY COUNCIL OF THE CITY OF BASTROP, TEXAS:

Section 1: That the City Council authorizes the City Manager to enter into a Lease of Site Agreement with CAPCOG for a portion of property at Mayfest Park for a term of five (5) year at a total rent of \$1.00 (One Dollar).

SECTION 2: All orders, ordinances, and resolutions, or parts thereof, which are in conflict or inconsistent with any provision of this Resolution are hereby repealed to the extent of such

conflict, and the provisions of this Resolution shall be and remain controlling as to the matters resolved herein.

Section 3: That this Resolution shall take effect immediately upon its passage, and it is so resolved.

DULY RESOLVED AND ADOPTED by the City Council of the City of Bastrop this 13th day of November, 2018.

APPROVED:

Connie B. Schroeder, Mayor

ATTEST:

Ann Franklin, City Secretary

APPROVED AS TO FORM:

Alan Bojorquez, City Attorney



Capital Area Council of Governments Lease of Site for Air Quality Monitoring

Sec.1. Parties and Purpose

1.1. The Capital Area Council of Governments ("CAPCOG") is a regional planning commission and political subdivision of the state of Texas organized and operating under the Texas Regional Planning Act of 1965, as amended, chapter 391 of the Local Government Code.

1.2. The City of Bastrop ("Bastrop") is a home rule city of the State of Texas, located in Bastrop County, Texas that owns land suitable for location of air quality monitoring equipment ("City Property").

1.3. CAPCOG has received funding from Clean Air Coalition members to monitor air quality in the Central Texas region. CAPCOG has acquired air quality monitoring equipment and a meteorological tower to carry out the grant, and CAPCOG has a contractor to operate the equipment. Bastrop has a site suitable for locating monitoring equipment, and CAPCOG desires to lease the site for this purpose.

Sec.2. Lease

2.1. Bastrop leases to CAPCOG and CAPCOG leases from Bastrop the site which is a portion of City Property, shown on the Attachment "A" to this lease, generally described as:

A 300 square foot portion of Tract situated in the Bastrop Town tract A-11 and being part of the City of Bastrop Mayfest Park Tract, said city park tract being the residual of tracts C-6 and A-21 according to the city map recorded in cabinet 1, slide 23-A, in the City of Bastrop, Bastrop County, Texas, as depicted in Attachment A attached hereto and incorporated herein by reference (the "Premises").

2.2. Bastrop agrees that CAPCOG may locate air quality monitoring equipment and a meteorological tower on the Premises ("Equipment") and such is the exclusive permitted use of the Premises. CAPCOG agrees to pay for installation and provision of necessary utilities to the Equipment. A list of the specific Equipment installed shall be attached to this Agreement as **Attachment "B"**. CAPCOG shall provide an updated list of the name of the equipment, manufacturer and serial number and whether the Equipment is owned by CAPCOG or its contractor prior to installation of the equipment and will update the list when Equipment is replaced, or in any event, at least semi-annually on January 15 and July 15 of each year to ensure there is adequate insurance coverage for the installed Equipment at all times. The most recent updated Equipment list shall be attached as Attachment B to this Lease without need for a formal amendment.

2.3. Bastrop agrees that employees of CAPCOG and CAPCOG's contractor have access to the Premises during Bastrop's normal business hours (Monday to Friday, 8 am to 5 pm, except holidays), to operate the monitoring equipment. CAPCOG agrees that Bastrop employees have access to the Premises for inspection.

2.4. CAPCOG shall have the right to enter the City Property only to access the Premises. CAPCOG agrees to provide Bastrop with 24 hour written notification (email or hand-delivered notice)

prior to entry into the facility of any employee of CAPCOG or CAPCOG's contractor. CAPCOG agrees to provide the names and other information Bastrop may reasonably require for each employee of CAPCOG or CAPCOG's contractor who will have access to the Premises. To the extent that any regulatory body requires that such person(s) be licensed, a copy of the license will be provided to Bastrop.

2.5. Bastrop acknowledges that CAPCOG or CAPCOG's contractor owns the air quality monitoring equipment and the meteorological tower located on the Premises, as shown in Attachment "B", and that this Lease does not transfer ownership of the air quality monitoring equipment or meteorological tower to Bastrop or create a security interest in them for Bastrop's benefit.

2.6. CAPCOG may not assign this Lease or sublet under this Lease without the prior written consent of the Bastrop City Council. An attempted assignment or sublet in violation of this paragraph is void.

2.7. Bastrop agrees to limit any request to relocate the air quality monitoring station to another site within the same City Property to situations which, in Bastrop's discretion, amount to good cause to relocate the operation and provide at least two weeks' advance notice before the effective date of any relocation. In the event that the Equipment is located to a replacement site that is not the area described as the Premises, the parties shall enter into an Amendment to this Lease.

Sec. 3. Term

3.1. This Lease begins on the date it is executed on behalf of Bastrop and it ends on December 31, 2023.

3.2. When this Lease ends, CAPCOG agrees at its expense to remove the air quality monitoring equipment and meteorological tower (aka the Equipment) from the Premises and to restore the Premises to its prelease condition, ordinary wear and tear excepted.

3.3. Either Party may terminate this contract with thirty (30) days written notice to the other Party.

Sec. 4. Rent

4.1. Total rent for lease of the Premises is \$1, the receipt and adequacy of which Bastrop acknowledges.

4.2 As additional consideration for this Lease, Bastrop finds that the air quality monitoring that is the permitted use is of municipal benefit to the citizens of Bastrop and the parties agree such public benefit and the rent is adequate consideration for the lease of the Premises to CAPCOG.

Sec. 5. Insurance

5.1. Throughout the term of this Lease, CAPCOG shall provide or cause its contractor to provide and keep in force for the benefit of Bastrop and CAPCOG, at its sole cost and expense, comprehensive general liability insurance in an amount not less than Two Hundred Fifty Thousand Dollars (\$250,000.00) for bodily injury for each occurrence, and for property damage, or automobile insurance in the amount of Five Hundred Thousand Dollars (\$500,000) in amounts equal to the maximum liability for damages for

municipalities for claims arising under governmental functions, provided for under the Texas Tort Claims Act, whichever is greater.

CAPCOG warrants that (1) CAPCOG is insured through the Texas Municipal League Intergovernmental Risk Pool if CAPCOG provides any of the air quality monitoring equipment or meteorological tower; and (2) CAPCOG's contractor has workers' compensation insurance covering its employees working on the Premises, and such comprehensive general liability and automobile liability insurance against death, personal injury, and property damage arising from its operations on the Premises, in at least the amounts set forth in Section 5.1, and Bastrop is named an additional insured on both liability insurance policies. A copy of the certificate of insurance shall be delivered to Bastrop at least ten (10) days prior to the effective date of the insurance policy for which the certificate is issued.

6.03 In the event of any construction on the Premises, CAPCOG, at its own cost and expense, shall cause to be made, executed, and delivered to Bastrop payment and performance bonds in compliance with Texas Government Code Section 2253.

Sec. 6. Dispute Resolution

6.1. The parties desire to resolve disputes arising under this Lease without litigation. Accordingly, if a dispute arises, the parties agree to attempt in good faith to resolve the dispute among themselves. To this end, the parties agree not to sue one another, except to enforce compliance with this Sec. 6, toll the statute of limitations, or seek an injunction, until they have exhausted the procedures set out in this Sec. 6.

6.2. At the written request of a party, each party shall appoint a representative to negotiate informally and in good faith to resolve any dispute arising under this Lease. The representatives appointed shall determine the location, format, frequency, and duration of the negotiations within 15 calendar days of the date of the notice.

6.3. If the representatives cannot resolve the dispute within 30 calendar days after the first negotiation meeting, the parties agree to refer the dispute to the Dispute Resolution Center of Austin for mediation in accordance with the Center's mediation procedures by a single mediator assigned by the Center. Each party shall pay half the cost of the Center's mediation services. Each party shall pay half the cost, if any, of the procedure.

6.4. The parties agree to continue performing their duties under this Lease, which are unaffected by the dispute, during the negotiation and mediation process.

Sec. 7. Notice to Parties

7.1. Notice to be effective under this Lease must be in writing and received by the party against whom it is to operate. Notice is received by a party: (1) when it is delivered to the party personally; (2) on the date shown on the return receipt if mailed by registered or certified mail, return receipt requested, to the party's address specified in paragraph 7.2 and signed on behalf of the party; or (3) three business days after its deposit in the United States mail, with first-class postage affixed, addressed to the party's address specified in paragraph 7.2.

7.2. CAPCOG's address is 6800 Burleson Road, Building 310, Suite 165, Austin, TX 78744, Attention: Betty Voights, Executive Director. Bastrop's address is 1311 Chestnut Street, Bastrop, Texas 78602, Attention: City Manager.

7.3. A party may change its address by providing notice of the change in accordance with paragraph 7.1.

Sec. 8. Miscellaneous

8.1. Each individual signing this Lease on behalf of a party warrants that he or she is legally authorized to do so and that the party is legally authorized to perform the obligations undertaken.

8.2. This Lease is the entire agreement of the parties, and an amendment is not effective unless in writing and signed by all parties.

8.3. The Attachments are part of this Lease, and integrated into this agreement as if fully set forth herein.

8.4. This Lease is binding on and inures to the benefit of the parties and the parties' successors in interest.

8.5. This Lease is performable in Bastrop County, Texas, and Texas law governs the interpretation and application of this Lease. Venue shall lie in Bastrop County, Texas.

8.6. CAPCOG may not permit any liens or encumbrances upon its leasehold estate or on the Premises or City Property, and will promptly take action to remove any such encumbrances upon notification by Bastrop.

8.7 This Lease may be executed in duplicate originals.

City of Bastrop

By _____
Lynda Humble, City Manager

Date _____

Capital Area Council of Governments

By _____
Betty Voights, Executive Director

Date _____

Attachment "A"

The following map shows the approximate location, outlined in red, where CAPCOG plans to locate the monitoring equipment, which will consist of, at a minimum, a trailer, an ozone monitor equipment, meteorological equipment, and communications equipment. CAPCOG may also install additional instruments to measure concentrations of particulate matter, nitrogen oxides, or other pollutants. Prior to setting up the equipment, CAPCOG will secure agreement with the facility management on the precise location on the Premises where the Equipment will be set and any procedures for site installation and access. The address of the location is Mayfest Park, 25 American Legion Dr., Bastrop, TX 78602.





STAFF REPORT

MEETING DATE: November 13, 2018

AGENDA ITEM: 9H

TITLE:

Consider action to approve the first reading of Ordinance 2018-31 amending the budget for the Fiscal Year 2019 in accordance with existing statutory requirements; appropriating the various amounts herein as attached in Exhibit "A"; repealing all prior ordinances and actions in conflict herewith; providing for an effective date; and move to include on the November 27, 2018 City Council consent agenda for a second reading.

STAFF REPRESENTATIVE:

Tracy Waldron, Chief Financial Officer

BACKGROUND/HISTORY:

The FY2019 budget was approved by City Council on September 24, 2018. Since that approval there have been some unforeseen amounts that need to be addressed through an amendment.

Opera House Carry-over:

The Opera House requested \$30,000 in restoration funds in FY2018, which City Council approved as a part of the budget. The Opera House only requested reimbursement and used \$10,642.84 of this approved amount. The Bastrop Opera House has requested to carry-over their undistributed restoration FY2018 funds of \$19,358 into FY2019. Their request and report are attached.

POLICY EXPLANATION:

The City Charter requires that when the budget is amended, that the amendment be made by Ordinance.

FUNDING SOURCE:

N/A

RECOMMENDATION:

Consider action to approve the first reading of Ordinance 2018-31 amending the budget for the Fiscal Year 2019 in accordance with existing statutory requirements; appropriating the various amounts herein as attached in Exhibit "A"; repealing all prior ordinances and actions in conflict herewith; providing for an effective date; and move to include on the November 27, 2018 City Council consent agenda for a second reading.

ATTACHMENTS:

- Ordinance 2018-31
- Exhibit "A"
- Backup Documentation

ORDINANCE NO. 2018-31

AN ORDINANCE OF THE CITY COUNCIL OF THE CITY OF BASTROP, TEXAS, AMENDING THE BUDGET FOR THE FISCAL YEAR 2019 IN ACCORDANCE WITH EXISTING STATUTORY REQUIREMENTS; APPROPRIATING THE VARIOUS AMOUNTS HEREIN; REPEALING ALL ORDINANCES AND ACTIONS IN CONFLICT HEREWITH; AND PROVIDING AN EFFECTIVE DATE.

WHEREAS, the City Manager of the City of Bastrop has submitted to the Mayor and City Council proposed amendment(s) to the budget of the revenues and/or expenditures/expenses of conducting the affairs of said city and providing a complete financial plan for Fiscal Year 2019; and

WHEREAS, the Mayor and City Council have now provided for and conducted a public hearing on the budget as provided by law.

NOW THEREFORE BE IT ORDAINED BY THE CITY COUNCIL OF THE CITY OF BASTROP, TEXAS THAT:

Section 1: That the proposed budget amendment(s) for the Fiscal Year 2019, as submitted to the City Council by the City Manager and which budget amendment(s) are attached hereto as Exhibit "A", are hereby adopted and approved as the amended budget of said city for Fiscal Year 2019.

Section 2: If any provision of this ordinance or application thereof to any person or circumstance shall be held invalid, such invalidity shall not affect the other provisions, or application thereof, of this ordinance, which can be given effect without the invalid provision or application, and to this end, the provisions of this ordinance are hereby declared to be severable.

Section 3: This ordinance shall take effect upon the date of final passage noted below, or when all applicable publication requirements, if any, are satisfied in accordance with the City's Charter, Code of Ordinances, and the laws of the State of Texas.

READ and APPROVED on First Reading on the 13th day of November 2018.

READ and ADOPTED on Second Reading on the 27th day of November 2018.

APPROVED:

Connie B. Schroeder, Mayor

ATTEST:

Ann Franklin, City Secretary

APPROVED AS TO FORM:

Alan Bojorquez, City Attorney

**FY 2019
BUDGET AMENDMENTS
HOTEL/MOTEL TAX FUND**

Projected Fund Balance as of 9-30-18	3,425,181
FY 2019 Budgeted Revenues	3,571,246
FY 2019 Budgeted Appropriations	(3,909,689)
10/2018 Budget Amendments (net)	(19,357)
Ending Fund Balance	<u><u>3,067,381</u></u>

DEPARTMENT	BUDGET	AMOUNT	DESCRIPTION	ACCOUNT #
New Expenditures:				
	Increase	(19,357)	Bastrop Opera House	501-80-00-5566
	Increase			
	Total Expense	<u>(19,357)</u>		
	Net Change	(19,357)		

From: [Lisa Holcomb](#)
To: [Sarah O'Brien](#)
Subject: Restoration Hot Funds
Date: Thursday, October 4, 2018 3:24:05 PM
Attachments: [Bastrop Opera House Field Conditions Reprot 2port \(1\).docx](#)

Hi Sarah,

The Bastrop Opera House recently hired an engineer who is very experienced in historical buildings to do a thorough inspection on the the Opera House to try to determine why the inside walls of the Opera House are once again peeling. He has completed his inspection and we have received his report and recommendations. He feels that there are several things that we need to do to make sure that the inside walls don't continue to deteriorate. I have attached his report.

We hope to have bids in for these projects by the end of October or slightly after. We would like to request that any funding we still have available for historical restoration be carried over to the new fiscal year. This would help the Opera House tremendously if the funds are still available.

Thank you, Sarah.

Lisa Holcomb
Executive Director
Bastrop Opera House

WARNING EXTERNAL EMAIL: This email is from an external source. Do not click links or open attachments without positive sender verification of purpose. Never enter Username, Password or sensitive information on linked pages from this email. If you are unsure about the message, please contact the IT Department for assistance.

Bastrop Opera House Field Conditions Report Site Trip August 21, 2018

Scott Moore:

Kim A. Williams, AIA was commissioned to review building and site conditions related to the exterior walls paint lack of adhesion and bubbling at the interior surface. Kim reviewed exterior site grade conditions, the attic areas, the roof, and performed limited interior surface testing. This report is also in part an update of the similar report from 1992 by Kim.

Based on the evidence and conditions observed, it appears that recent exterior wall repair work performed by one contractor may be the main concern for the interior paint delamination. The following analysis and predicted resolve:

Main Issues of Concern:

- Exterior brick wall repointing- the contractor (Steve Neuhaus) repointed the East wall with a more contemporary Portland based mortar mix. This condition also involved some historic preservation proper treatment expressed by the THC but overlooked and approved in a letter from the NPS. Although that interaction had more to do with the structural appropriate also has a relationship to the permeability of moisture in the masonry wall – possibly trapping more moisture than the original lime based mortar. This moisture reducing process may be causing more moisture (both water and water vapor) movement to the cooler / dryer interior surface.
- The east side of the building grade (soil) conditions has some negative drainage towards the façade and depressions that allow water into the foundation areas. The soft , porous brick footers and walls soak water upwards called “rising damp”. It is not clear how much of this problem is contributing to moist wall conditions but a positive slope away from the building must be created. This concern was stated in the 1992 report and apparently not corrected.
- The interior wall surface was coated with a gypsum drywall leveling layer and then a coat of new paint (paint type to be determined- see next item). As the exterior moisture / pressure moves to the interior surface, it has forced a release of the gypsum coating from the original plaster / paint surface which appears reasonably intact. The owner and painter shall confirm the new base layer and paint type such that more correction recommendation can be made.
- Follow-up information from Scott indicates the contractor’s materials as follows: Re-plaster , Type N Polypropylene Stucco mix, Sto base Coat, drywall

compound, oil base primer, S-W Emerald final top coat / latex. This total combination of system is unusual and unexplained for all the base layers.

- The historic brick is a hand or early machine pressed fabrication but not a fired glazed more water resistant face brick. Therefore the historic brick is more porous than contemporary brick. Additionally as masonry bearing wall there is no cavity space or other moisture protection assembly. Coupled with the use of AC equipment and de-humidification process, the cooler dryer interior air tends to pull the moist and warm exterior air towards the interior surface.
- The roof conditions involve a relative new TPO single membrane roof system placed on a gabled form and internal butter design with the removal of the metal roof. This roof membrane is still under both installer full warranty and the 15 year manufacturer warranty. The roofer proposal serves as the only written documentation which does not state the actual manufacturer or detailed assembly (whether any rigid insulation was placed below the TPO). The gable form, wood deck and lack of insulation may not be constructed to industry standards or warranty requirements. More research and interaction with the roofer will be required to define this matter. Additionally the roofer did not install the parapet vertical membrane with a proper detail standard of cap flashing covering the top edge. Only a continuous compression bar with top edge caulk and screw attachment to the wall was used. Current caulk deterioration and bar openings is allowing some water into the parapet wall which may also attribute some of the moisture into the masonry wall.
- There is also historic interior wall paint failure at the northwest corner - balcony staircase area. This wall surface was not treated as the East wall but rather reflects previous and possibly current moisture penetration from the roof scupper area. This area receives an extreme volume of direct water movement including half of the opera house and the adjacent (west) building that penetrates the common wall parapet and discharges one third of its roof onto this roof. This condition was identified in the 1992 report and apparently no action to correct it was taken.

Recommendations relative to the problem issues:

- The exterior wall repointing probably cannot be changed at this point. As a partial moisture relief technique, a few weep hole installation may allow the wall to breath better; however since there is no defined airspace or moisture proofing barrier plane, this strategy may have only a minimal impact. The porous brick state can be improved through the specific use of appropriate

moisture resistance treatment of an applied siloxane penetrating chemical treatment (not a waterproofing coating such as clear silicone). This treatment works to resist water penetration while allowing internal moisture release or breathing. Specific recommendation is – Prosoco, Sure Clean Weather Seal, Siloxane PD.

- The east side site drainage should be corrected to create total positive drainage away from the brick façade for a distance of at least 10 ft. Flat stone pavers can be laid at grade and façade connection and some type of impervious fill i.e. road base material used for full length of building and approximately 10' out.
- I do not believe that the interior application of a leveling or covering gypsum finish plus a contemporary paint was an appropriate treatment. Upon confirming the chemical composition of these recent materials, Kim can request expert technical representatives of Sherwin Williams Paint to visit the site and offer best recommendations for paint repair. This process could involve the removal of the recent coatings.
- See the first item.
- A joint meeting of the roofer , roof manufacturer , Owner and Kim should be held to review the contract installation, warranty issues, manufacturer warranty detail requirements, industry standards and corrective parapet cap detailing. The west common wall and shared scupper drainage should be legally and technically reviewed and resolved.
- Once the west scupper is resolved and corrected, the interior wall should be fully dried (to 15% moisture content) and then repaired and repainted.

This report has been provided as a general site review and recommendations but not necessarily as a detailed architectural restoration detailing or specifications for the actual intended work or final action plan. If the Owner wishes to have Kim A. Williams to guide this process and next steps , he can continue on an hourly rate fee basis for additional site meetings, analysis, and admin. of the implementation process and work.

Reference attached photos and listing description in attached information.

Submitted August 27, 2018

Kim A. Williams, AIA

Bastrop Opera House Field Conditions Report Site Trip August 21, 2018

Scott Moore:

Kim A. Williams, AIA was commissioned to review building and site conditions related to the exterior walls paint lack of adhesion and bubbling at the interior surface. Kim reviewed exterior site grade conditions, the attic areas, the roof, and performed limited interior surface testing. This report is also in part an update of the similar report from 1992 by Kim.

Based on the evidence and conditions observed, it appears that recent exterior wall repair work performed by one contractor may be the main concern for the interior paint delamination. The following analysis and predicted resolve:

Main Issues of Concern:

- Exterior brick wall repointing- the contractor (Steve Neuhaus) repointed the East wall with a more contemporary Portland based mortar mix. This condition also involved some historic preservation proper treatment expressed by the THC but overlooked and approved in a letter from the NPS. Although that interaction had more to do with the structural appropriate also has a relationship to the permeability of moisture in the masonry wall – possibly trapping more moisture than the original lime based mortar. This moisture reducing process may be causing more moisture (both water and water vapor) movement to the cooler / dryer interior surface.
- The east side of the building grade (soil) conditions has some negative drainage towards the façade and depressions that allow water into the foundation areas. The soft , porous brick footers and walls soak water upwards called “rising damp”. It is not clear how much of this problem is contributing to moist wall conditions but a positive slope away from the building must be created. This concern was stated in the 1992 report and apparently not corrected.
- The interior wall surface was coated with a gypsum drywall leveling layer and then a coat of new paint (paint type to be determined- see next item). As the exterior moisture / pressure moves to the interior surface, it has forced a release of the gypsum coating from the original plaster / paint surface which appears reasonably intact. The owner and painter shall confirm the new base layer and paint type such that more correction recommendation can be made.
- Follow-up information from Scott indicates the contractor’s materials as follows: Re-plaster , Type N Polypropylene Stucco mix, Sto base Coat, drywall

compound, oil base primer, S-W Emerald final top coat / latex. This total combination of system is unusual and unexplained for all the base layers.

- The historic brick is a hand or early machine pressed fabrication but not a fired glazed more water resistant face brick. Therefore the historic brick is more porous than contemporary brick. Additionally as masonry bearing wall there is no cavity space or other moisture protection assembly. Coupled with the use of AC equipment and de-humidification process, the cooler dryer interior air tends to pull the moist and warm exterior air towards the interior surface.
- The roof conditions involve a relative new TPO single membrane roof system placed on a gabled form and internal butter design with the removal of the metal roof. This roof membrane is still under both installer full warranty and the 15 year manufacturer warranty. The roofer proposal serves as the only written documentation which does not state the actual manufacturer or detailed assembly (whether any rigid insulation was placed below the TPO). The gable form, wood deck and lack of insulation may not be constructed to industry standards or warranty requirements. More research and interaction with the roofer will be required to define this matter. Additionally the roofer did not install the parapet vertical membrane with a proper detail standard of cap flashing covering the top edge. Only a continuous compression bar with top edge caulk and screw attachment to the wall was used. Current caulk deterioration and bar openings is allowing some water into the parapet wall which may also attribute some of the moisture into the masonry wall.
- There is also historic interior wall paint failure at the northwest corner - balcony staircase area. This wall surface was not treated as the East wall but rather reflects previous and possibly current moisture penetration from the roof scupper area. This area receives an extreme volume of direct water movement including half of the opera house and the adjacent (west) building that penetrates the common wall parapet and discharges one third of its roof onto this roof. This condition was identified in the 1992 report and apparently no action to correct it was taken.

Recommendations relative to the problem issues:

- The exterior wall repointing probably cannot be changed at this point. As a partial moisture relief technique, a few weep hole installation may allow the wall to breath better; however since there is no defined airspace or moisture proofing barrier plane, this strategy may have only a minimal impact. The porous brick state can be improved through the specific use of appropriate

moisture resistance treatment of an applied siloxane penetrating chemical treatment (not a waterproofing coating such as clear silicone). This treatment works to resist water penetration while allowing internal moisture release or breathing. Specific recommendation is – Prosoco, Sure Clean Weather Seal, Siloxane PD.

- The east side site drainage should be corrected to create total positive drainage away from the brick façade for a distance of at least 10 ft. Flat stone pavers can be laid at grade and façade connection and some type of impervious fill i.e. road base material used for full length of building and approximately 10' out.
- I do not believe that the interior application of a leveling or covering gypsum finish plus a contemporary paint was an appropriate treatment. Upon confirming the chemical composition of these recent materials, Kim can request expert technical representatives of Sherwin Williams Paint to visit the site and offer best recommendations for paint repair. This process could involve the removal of the recent coatings.
- See the first item.
- A joint meeting of the roofer , roof manufacturer , Owner and Kim should be held to review the contract installation, warranty issues, manufacturer warranty detail requirements, industry standards and corrective parapet cap detailing. The west common wall and shared scupper drainage should be legally and technically reviewed and resolved.
- Once the west scupper is resolved and corrected, the interior wall should be fully dried (to 15% moisture content) and then repaired and repainted.

This report has been provided as a general site review and recommendations but not necessarily as a detailed architectural restoration detailing or specifications for the actual intended work or final action plan. If the Owner wishes to have Kim A. Williams to guide this process and next steps , he can continue on an hourly rate fee basis for additional site meetings, analysis, and admin. of the implementation process and work.

Reference attached photos and listing description in attached information.

Submitted August 27, 2018

Kim A. Williams, AIA



STAFF REPORT

MEETING DATE: November 13, 2018

AGENDA ITEM: 9H

TITLE:

Consider action to approve Resolution No. R-2018-106 of the City Council of the City of Bastrop, Texas approving a Wholesale Water Service Agreement with Aqua Water Supply Corporation, attached as Exhibit A; authorizing the City Manager to execute all necessary documents; providing for a severability clause; and establishing an effective date.

STAFF REPRESENTATIVE:

Lynda K. Humble, City Manager

Trey Job, Managing Director of Public Works & Leisure Services

BACKGROUND/HISTORY:

Texas Water Code – Water §13.254, Revocation or Amendment of Certificate codifies SB 511, which created a streamlined expedited release of a Certificate of Convenience and Necessity (CCN) for landowners with at least 25 acres, who are not receiving water and wastewater service, and are located in one (1) of 33 counties to petition the Texas Commission on Environmental Quality (TCEQ) to remove their property from an existing CCN. Bastrop is one (1) of the 33 counties. There is no requirement to notify the existing CCN holder or that an alternative service provider be available and capable of providing service. The TCEQ is required to grant a petition for streamlined expedited release within 60 days, if all applicable requirements are met. The new retail provider is required to compensate the incumbent utility for any property TCEQ determines is rendered useless or valueless.

In 2017, Aqua Water Corporation worked with Representative John Cyrier to sponsor a bill to modify this process. The City of Bastrop opposed the bill. Representative Cyrier called a meeting with representatives from the City of Bastrop and Aqua Water Corporation and instructed both entities to work out some form of an agreement. Multiple meetings have occurred over the past 1 ½ years to reach a solution that creates a win-win scenario for both entities.

POLICY EXPLANATION:

Specific goals of a mutual contract were discussed with Council at the March 24th Work Session. Under this contract, the City agrees to purchase water at a wholesale cost for any development that wishes to decertify Aqua’s water CCN under Texas Water Code – Water §13.254, Revocation or Amendment of Certificate and have the City of Bastrop provide water. This contract ensures the following:

- Aqua maintains the collateral commitment for their USDA loans by still providing water at a wholesale cost to the same customers that use to be in their CCN. The City will establish a wholesale water rate that covers the cost of Aqua’s water, et is cheaper than a developer installing their own water system.

- Economic development challenge is resolved regarding fire flow. Aqua can provide fire flow, but a customer must buy more water (volume) that is required to pressurize the system. A connection will be made at SH20 between the City of Bastrop and Aqua that will allow the wholesale water purchase to be pressurized in the City's system for fire flow purposes, which will require less water to be purchased.
- This agreement provides a "one-stop" shop for economic development opportunities regarding supplying water and wastewater services.
- The City of Bastrop will be able to expand our Water CCN to match our Wastewater CCN through a long-term wholesale water agreement.
- This agreement will provide immediate water supply redundancy that we currently do not have and helps manage peak demand until a new plant can be built in the Simsboro Aquifer.

The terms of this mutual contract are as follows:

- Provides a process for Aqua to apply to the Public Utility Commission (PUC) to amend their CCN to decertify and amend the City's CCN to accept certification.
- Associated costs such as Points of Service studies, connections, CCN amendments, etc. will be included in the City's wholesale water agreement and paid by the customer, who benefits from the service.
- Majority of the contract functions as a "Wholesale Water Purchase Agreement" and covers definitions, maintenance and curtailment, rates, and process for adjustment of rates.
- City agrees to pledge revenue from wholesale water agreements to cover cost of water purchased from Aqua.
- City agrees to follow Aqua's conservation measures.
- If there is a dispute not covered by the jurisdiction of the PUC, both parties agree to non-binding mediation.
- If the agreement is terminated prior the initial agreed upon term, the City agrees to pay Aqua's "stranded investment."
- The City must notify Aqua within one year from date of expiration of written intent to not renew. If no notice is given, the agreement will automatically renew based on the renewal period established by Council.

Both Aqua Water Corporation and the City of Bastrop believe this mutual agreement is a precedent setting agreement for the State of Texas. It represents a win-win-win scenario for Aqua, the City, and the wholesale customer.

The attached mutual contract with Aqua leaves the term of the agreement blank along with the renewal period. However, the Aqua Board has authorized its General Manager to execute the agreement once the Bastrop City Council approves the number of years establishing the initial term and the time of the renewal period. Council will need to determine both the term and renewal period and include these time periods in the motion.

RECOMMENDATION:

Consider action to approve Resolution No. R-2018-106 of the City Council of the City of Bastrop, Texas approving a Wholesale Water Service Agreement with Aqua Water Supply Corporation, attached as Exhibit A; authorizing the City Manager to execute all necessary documents; providing for a severability clause; and establishing an effective date.

ATTACHMENT:

- Resolution
- Mutual Contract with Aqua



RESOLUTION NO. R-2018-106

A RESOLUTION OF THE CITY COUNCIL OF THE CITY OF BASTROP, TEXAS, APPROVING AN AGREEMENT WITH AQUA AS ATTACHED IN EXHIBIT A; AUTHORIZING THE CITY MANAGER TO EXECUTE ALL NECESSARY DOCUMENTS; PROVIDING FOR A REPEALING CLAUSE; AND ESTABLISHING AN EFFECTIVE DATE.

WHEREAS, Texas Water Code – Water §13.254, Revocation or Amendment of Certificate codifies SB 511, which created a streamlined expedited release of a Certificate of Convenience and Necessity (CCN) for landowners with at least 25 acres, who are not receiving water and wastewater service, and are located in one (1) of 33 counties to petition the Texas Commission on Environmental Quality (TCEQ) to remove their property from an existing CCN. Bastrop is one (1) of the 33 counties; and

WHEREAS, in 2017, Aqua Water Corporation worked with Representative John Cyrier to sponsor a bill to modify this process. The City of Bastrop opposed the bill. Representative Cyrier called a meeting with representatives from the City of Bastrop and Aqua Water Corporation and instructed both entities to work out some form of an agreement; and

WHEREAS, multiple meetings have occurred over the past 1 ½ years to reach a solution that creates a win-win scenario for both entities; and

WHEREAS, under this contract, the City agrees to purchase water at a wholesale cost for any development that wishes to decertify Aqua's water CCN under Texas Water Code – Water §13.254, Revocation or Amendment of Certificate and have the City of Bastrop provide water; and

WHEREAS, Aqua Water Corporation maintains the collateral commitment for their USDA loans by still providing water at a wholesale cost to the same customers that use to be in their CCN. The City will establish a wholesale water rate that covers the cost of Aqua's water, yet is cheaper than a developer installing their own water system; and

WHEREAS, the economic development challenge regarding fire flow is resolved through a connection at SH20 between the City of Bastrop and Aqua that will allow the wholesale water purchase to be pressurized in the City's system for fire flow purposes, which will require less water to be purchased; and

WHEREAS, this agreement provides a "one-stop" shop for economic development opportunities regarding supplying water and wastewater services; and

WHEREAS, the City of Bastrop will be able to expand its Water CCN to match its Wastewater CCN through a long-term wholesale water agreement; and

WHEREAS, this agreement will provide immediate water supply redundancy that we currently do not have and helps manage peak demand until a new plant can be built in the Simsboro Aquifer; and

WHEREAS, both Aqua Water Corporation and the City of Bastrop believe this mutual agreement is a precedent setting agreement for the State of Texas and represents a win-win-win scenario for Aqua, the City, and the wholesale customer.

NOW, THEREFORE, BE IT RESOLVED BY THE CITY COUNCIL OF THE CITY OF BASTROP, TEXAS:

Section 1. The City Manager is hereby authorized to execute this contract, which is attached as Exhibit A, as well as all other necessary documents.

Section 2. All orders, ordinances, and resolutions, or parts thereof, which are in conflict or inconsistent with any provision of this Resolution are hereby repealed to the extent of such conflict, and the provisions of this Resolution shall be and remain controlling as to the matters resolved herein.

Section 3. This resolution shall take effect immediately from and after its passage, and it is duly resolved.

DULY RESOLVED AND ADOPTED by the City Council of the City of Bastrop this 13th day of November 2018.

APPROVED:

Connie B. Schroeder, Mayor

ATTEST:

Ann Franklin, City Secretary

APPROVED AS TO FORM:

Alan Bojorquez, City Attorney

WHOLESALE WATER SERVICE AGREEMENT

BETWEEN

AQUA WATER SUPPLY CORPORATION

AND

CITY OF BASTROP

WHOLESALE WATER SERVICE AGREEMENT

TABLE OF CONTENTS

ARTICLE I. DEFINITIONS AND CONSTRUCTION OF AGREEMENT	7
1.1 Defined Terms	7
1.2 Rules of Construction	13
1.3 Recitals.....	14
1.4 Captions	14
ARTICLE II. PROVISION OF WATER	14
2.1 Agreement to Sell and Purchase	14
2.2 Quantity of Water to be Delivered.....	15
2.3 Rate of Delivery and Pressure.....	15
2.4 Responsibilities of Purchaser and Aqua	15
2.5 Water Quality.....	16
2.6 Sale of Water by Purchaser	17
2.7 Separation of Systems.....	17
2.8 CCN Amendment Application.....	18
ARTICLE III. MAINTENANCE AND CURTAILMENT	18
3.1 Planned Outages.....	18
3.2 Forced Outages	18
3.3 Curtailment	19
3.4 Conservation Measures	20
3.5 Emergency Notification	20
3.6 No Statutory Violation for Curtailment	20
ARTICLE IV. RATES AND COMPENSATION.....	21
4.1 Rates.....	21
4.2 Adjustment to Rates.....	21
4.3 Pass-through of Rate Adjustments and Other Costs Imposed by Third Parties	22
4.4 Books and Records	22
4.5 Reasonableness of Rates	22
4.6 Rate Case	23
4.7 Pledge of Revenues.....	23
4.8 Funds on Hand	23
ARTICLE V. EQUIPMENT AND OPERATION	23
5.1 Master Meter(s).....	23
5.2 Access to Master Meter(s)	24
5.3 Reading of Meter	24
5.4 Regular Testing of Master Meter(s).....	24
5.5 Additional Testing of Master Meter(s)	25
5.6 Maintenance of Master Meter(s).....	26
ARTICLE VI. POINT(S) OF DELIVERY	26
6.1 Location of and Cost Responsibility for Point(s) of Delivery	26
6.2 Relocation of Point(s) of Delivery	26
6.3 Acquisition of Necessary Easements	26

ARTICLE VII. OWNERSHIP OF WATER AND FACILITIES	27
7.1 Transfer of Ownership	27
7.2 No Ownership of Facilities	27
ARTICLE VIII. BILLING AND PAYMENT	27
8.1 Meter Readings	27
8.2 Breach for Failure to Timely Pay.....	28
8.3 Disputed Bills.....	28
ARTICLE IX. FORCE MAJEURE	28
9.1 Procedure for Calling Force Majeure	28
9.2 Effects of Force Majeure	30
9.3 Limitations on Force Majeure.....	30
ARTICLE X. DEFAULT AND TERMINATION	30
10.1 Event of Default.....	30
10.2 Remedies.....	31
10.3 Aqua Right to Suspend or Terminate.....	31
10.4 Termination for Continued or Multiple Force Majeure.....	32
10.5 Effective Date of Termination for Continued or Multiple Force Majeure	32
10.6 Mutual Termination by Parties	33
ARTICLE XI. DISPUTE RESOLUTION	33
11.1 Attempt to Resolve	33
11.2 Non-Binding Mediation for Matters not under PUC Jurisdiction	33
11.3 Rates Not Subject to Mediation	34
11.4 Costs of Mediation.....	34
ARTICLE XII. LIABILITY	34
12.1 Limitation on Liability and Responsibility / Hold Harmless.....	34
12.2 General Limitation on Liability	34
ARTICLE XIII. REPRESENTATIONS, WARRANTIES AND COVENANTS	35
13.1 Aqua Representations and Warranties	35
13.2 Purchaser Representations and Warranties.....	36
ARTICLE XIV. TERM	37
ARTICLE XV. MISCELLANEOUS.....	37
15.1 Assignment	37
15.2 Governing Law and Venue.....	38
15.3 Notices	38
15.4 No Waiver of Rights	39
15.5 Severability	39
15.6 Entire Agreement.....	40
15.7 Amendments	40
15.8 Cooperative Drafting	40
15.9 Counterparts.....	40
15.10 Third Party Beneficiaries	41
15.11 Certified Copy to PUC.....	41
15.12 Deadlines.....	41

EXHIBITS

Exhibit A – Aqua WSC’s Retail Water CCN Service Area as of Effective Date

Exhibit B – Aqua WSC’s Terms and Conditions for Wholesale Service Outside CCN No. 10294

Exhibit C – Description(s), Map(s) of Point(s) of Delivery, and Technical Information for Point(s) of Delivery

Exhibit D – Map of Aqua WSC’s Retail Water CCN Service Area, City of Bastrop’s Retail Wastewater CCN Service Area, and Areas of Overlap between Both CCN Service Areas

Exhibit E – City of Bastrop Water CCN Service Area as of Effective Date

Exhibit F – City of Bastrop Wastewater CCN Service Area as of Effective Date

Exhibit G – Resolution of the Aqua WSC Board of Directors

Exhibit H – Aqua WSC’s Water Rationing Plan

WHOLESALE WATER SERVICE AGREEMENT

THIS WHOLESALE WATER SERVICE AGREEMENT is made and entered into by and between Aqua Water Supply Corporation (hereinafter called “Aqua”), a non-profit water supply corporation operating under Texas Water Code Chapter 67 in Bastrop, Caldwell, Williamson, Lee, Fayette, and Travis Counties, Texas, and the City of Bastrop (hereinafter called “Purchaser”), a home rule city, body politic of the State of Texas, and retail public utility. This Agreement is effective on the date of the last to execute below, (the “Effective Date”).

WITNESSETH:

WHEREAS, Bastrop County is experiencing substantial economic and population growth and the growth will continue for the decades to come; and

WHEREAS, Aqua and Purchaser are both integral parts of the past, present, and future of Bastrop County; and

WHEREAS, Aqua and Purchaser strongly agree that the two entities must work together both now and in the future to not only address the growth and water needs that Bastrop County is experiencing but to enable Bastrop County to meet its full potential as a great place to work and live; and

WHEREAS, Aqua and Purchaser believe this Agreement is crucial to making certain the Purchaser has the water the area needs to grow; and

WHEREAS, Aqua holds retail water Certificate of Convenience and Necessity (“CCN”) No. 10294, issued by the Texas Commission on Environmental Quality, (“TCEQ”) or its predecessors or successors in interest, identified as Exhibit “A” and made a part hereto; and

WHEREAS, Purchaser holds retail water CCN No. 11198, issued by the TCEQ or its predecessors or successors in interest, which is adjacent to Aqua's retail water CCN and identified as Exhibit "E"; and

WHEREAS, Purchaser holds retail wastewater CCN No. 20466, issued by the TCEQ or its predecessors or successors in interest, identified as Exhibit "F"; and

WHEREAS, on September 1, 2014, the Public Utility Commission ("PUC") took over regulation of water utility rates and services including wholesale water rate appeals and the issuance of water and wastewater CCNs; and

WHEREAS, Purchaser desires to contract with Aqua for the purchase of wholesale water service ("Wholesale Service") to be provided by Aqua; and

WHEREAS, Aqua's Terms and Conditions, attached hereto as Exhibit "B" and which may be amended from time to time, set forth the minimum conditions under which it will agree to provide Wholesale Service to Purchaser; and

WHEREAS, Purchaser shall submit an application to Aqua for Wholesale Service under the provisions of Aqua's Terms and Conditions for each Point of Delivery and area of service from Aqua; and

WHEREAS, Aqua has determined that Aqua has sufficient water supplies available to enable it to contract with Purchaser for Wholesale Service, and has documented such findings with a Resolution adopted by its Board of Directors, attached hereto as Exhibit "G"; and

WHEREAS, Aqua and Purchaser wish to enter into an agreement whereby Aqua will provide Wholesale Service to Purchaser at rates that are generally applicable and uniformly applied to similarly situated purchasers; and

WHEREAS, Aqua and Purchaser wish to enter into an agreement that may be amended from time to time to include additional locations where Purchaser will receive Wholesale Service from Aqua upon the subsequent written request by Purchaser for additional Wholesale Service under this Agreement, and only in such areas where Aqua's retail water CCN service area and Purchaser's retail wastewater CCN service area overlap, as further detailed in the map attached hereto as Exhibit "D"; and

WHEREAS, Purchaser intends to take water purchased from Aqua pursuant to this Agreement at the locations as specified in Exhibit "C" and which may be amended from time to time as such locations may change and/or water is used by Purchaser at additional locations; and

WHEREAS, the Wholesale Service to be provided by Aqua hereunder and purchased by Purchaser is for a public purpose and not for the benefit of any private entity; and

WHEREAS, the provision of Wholesale Service to Purchaser by Aqua will further the public purpose of regionalization of water supplies;

NOW THEREFORE, in consideration of the foregoing and the mutual agreements hereinafter set forth, and for other good and valuable consideration, the receipt and adequacy of which is hereby acknowledged, Aqua agrees to furnish and Purchaser agrees to pay for Wholesale Service upon the Terms and Conditions and for the consideration set forth herein.

**ARTICLE I.
DEFINITIONS AND CONSTRUCTION OF AGREEMENT**

1.1 **Defined Terms.** Capitalized terms used in this Agreement and in any exhibit or attachment that is made a part of this Agreement, and not otherwise defined herein, shall have the meanings contained in Aqua's Terms and Conditions. The following additional terms shall have the meanings set forth herein:

(a) “Agreement” means this contract or agreement between the Parties, otherwise known as the Wholesale Service Agreement and any written amendments thereto.

(b) “Annual Daily Average” means the total amount of water taken by Purchaser in the prior Water Year, divided by 365.

(c) “Aqua Indemnified Party” means Aqua, its officials, employees, contractors, agents and representatives.

(d) “Business Day” means any Day other than Saturdays, Sundays, and Days on which banks in the Service Area of Aqua are required or permitted to be closed for all or part of their customary hours of operation.

(e) “CCN” means a certificate of convenience and necessity granted by the Texas Commission on Environmental Quality or its predecessor or successor agency, or the Public Utility Commission under the provisions of the Texas Water Code.

(f) “Claim” means any claim, action, cause of action, suit or proceeding before any Governmental Authority or arbitral tribunal.

(g) “Commencement Date” means the date that Aqua begins providing Wholesale Service to Purchaser at the Point of Delivery.

(h) “Day” and “Days” mean and refer to calendar day(s), unless otherwise specified herein.

(i) “Effective Date” means the date set forth above on which this Agreement becomes effective.

(j) “Event of Default” means an event by which a Party is in default of this Agreement.

(k) “Force Majeure” means, and shall be limited to, any event or circumstance that is beyond the reasonable control of, without the fault or negligence of, and should not, in the exercise of reasonable caution, have been foreseen and avoided or mitigated by, the Party asserting Force Majeure (the “Affected Party”), and which delays or prevents the Affected Party from timely performing any obligation hereunder, including, without limitation: (i) acts of God, earthquakes, fire, storms, unprecedented droughts that render Aqua unable to provide water to its members and purchasers, floods, lightning, hurricanes, tornadoes, and severe snow storms; (ii) explosions, wars, civil insurrections, acts of the public enemy, acts of civil or military authority, sabotage, and terrorism; (iii) strikes, lockouts or other labor disputes with respect to which the Affected Party has not been determined by the National Labor Relations Board to have engaged in any unfair labor practices; and (iv) any change in any Requirement of Law or the interpretation thereof by a responsible Governmental Authority that shall in any circumstances impact a Party’s ability to perform its obligations of the Agreement; provided, a “Force Majeure” shall not include economic conditions that render a Party’s performance of this Agreement unprofitable or otherwise uneconomic, or the inability of a Party to make payment when due under this Agreement, unless the cause of such inability is an event that physically prevents payment and that would otherwise constitute Force Majeure as described above.

(l) “Forced Outage” means a shut-down by Aqua in the operation of all or a portion of Aqua’s System, such that no water is delivered to Purchaser’s Point of Delivery: (i) which shut-down is, in the reasonable opinion of Aqua, necessary or required to protect persons or property (including the System) from contamination or releases that could reasonably result in harm, injury, or material damage; and (ii) with respect to which Aqua has notified Purchaser in accordance with Section 3.2.

(m) “Governmental Authority” means and includes any federal, state, local or other governmental body, including but not limited to the Lost Pines Groundwater Conservation District, the Gonzales County Underground Water Conservation District, the Fayette County Underground Water Conservation District, any governmental or quasi-governmental, regulatory or administrative agency, commission, body, or other authority exercising or entitled to exercise any administrative, executive, judicial, legislative, policy, regulatory or taxing authority or power; or any court or other governmental tribunal.

(n) “Loss(es)” means and includes any loss, cost, expense, Claim, demand, damage, fine, liability, obligation or penalty (including court costs and reasonable attorney’s fees and expenses) to the extent allowed by law.

(o) “Master Meter(s)” means the necessary metering equipment, including a meter house or pit, and any other required devices of standard type, for properly measuring the quantity and delivery rate of water delivered by Aqua to Purchaser at the Point(s) of Delivery.

(p) “Maximum Daily Delivery Rate” means the maximum rate at which Aqua is obligated to deliver water to Purchaser in one twenty-four (24) hour period.

(q) “Maximum Instantaneous Delivery Rate” means the Maximum Daily Delivery Rate expressed in gallons per minute. For example, a Maximum Daily Delivery Rate of 1 MGD is equivalent to a Maximum Instantaneous Delivery Rate of 694.4 gallons per minute.

(r) “MGD” means millions of gallons per day.

(s) “New Rate Billing Cycle” means the second billing cycle after the New Rate Effective Date.

(t) “Party” or “Parties” means Purchaser, Aqua, and their respective successors or/and assigns.

(u) “Permit” means any permit, order, license, declaration, consent, waiver, approval, registration, or filing with or other requirement of any Governmental Authority.

(v) “Planned Outage” means a shut-down by Aqua in the operations of Aqua’s System, such that no water is delivered to the Point(s) of Delivery: (i) which shut-down is scheduled by Aqua in order to carry out foreseeable preventive, corrective, and other maintenance activities on such System or which may be required by any Governmental Authority; (ii) for which Aqua has notified Purchaser in accordance with Section 3.1; (iii) which occurs no more than two (2) times in one (1) calendar year; and (iv) lasts for no more than three (3) Days unless another time period is mutually agreed-to in writing by both Parties.

(w) “Point(s) of Delivery” means one or more point(s) designated and approved under this Agreement at which Purchaser may withdraw water from Aqua’s System for distribution as more particularly described in Article VI and in Exhibit “C”.

(x) “Prevailing Pressure” means the pressure of Aqua’s System at the Point(s) of Delivery as specifically provided in pounds per square inch (psi) for each Point of Delivery in Exhibit “C”.

(y) “Purchaser Indemnified Party” means Purchaser, its officials, employees, contractors, agents, and representatives.

(z) “Rate” or “Rates” means the price to be paid by Purchaser to Aqua for the purchase and delivery of water to Purchaser’s Point(s) of Delivery under this Agreement, which Rate shall be based on Aqua’s then current Terms and Conditions.

(aa) “Rate Effective Date” means the date on which Aqua adopts new Rates.

(bb) “Requirement of Law” means any statute, ordinance, code, rule or regulation, tariff or policy, and judicial or administrative order, request or judgment, any common law

doctrine or theory, any provision or condition of any Permit, or any other binding determination of any Governmental Authority.

(cc) “Service Area” means the area contained within Aqua’s CCN or Purchaser’s CCN, as appropriate, as may be amended from time to time.

(dd) “System” means collectively all of Aqua’s production, distribution, and transmission facilities, including, without limitation, wells, ground storage reservoirs, pump stations, elevated storage tanks, water transmission and distribution lines connecting any of the aforementioned facilities, and other properties or interest therein wherever located for the production, distribution, and transmission of water, which heretofore have been acquired or constructed by Aqua, together with all future improvements, enlargements, extensions and additions to any of the foregoing, and all the future new facilities that are required or constructed by Aqua, and all repairs to, or replacement of, the System.

(ee) “Tariff” means the Water Supply Corporation Tariff for Aqua, as approved by Aqua’s Board of Directors, and as may be amended or revised from time to time.

(ff) “TCEQ” or “Commission” means the Texas Commission on Environmental Quality, and its successor agencies.

(gg) “Terms and Conditions for Wholesale Service Outside CCN No. 10294” or “Terms and Conditions” shall mean the Aqua Water Supply Corporation Terms and Conditions for Wholesale Service Outside CCN No. 10294, as adopted by the Aqua Board of Directions, and as may be amended from time to time by Aqua.

(hh) “Water Year” means a calendar Year.

(ii) “Year” and “Years” mean and refer to calendar year(s).

1.2 Rules of Construction.

(a) Unless the context otherwise clearly requires:

(i) references to the plural include the singular, and references to the singular include the plural;

(ii) references to the masculine, feminine or neuter include all such forms;

(iii) the words “include,” “includes,” and “including” do not limit the preceding terms or words and shall be deemed to be followed by the words “without limitation”;

(iv) the terms “hereof,” “herein,” “hereunder,” “hereto,” and similar terms refer to the entire agreement in which they appear and not to any particular provision of such agreement; and

(v) “or” is used in the inclusive sense of “and/or.”

(b) Unless otherwise specified, any reference to any document, instrument or agreement:

(i) includes and incorporates all exhibits, schedules and other attachments thereto;

(ii) includes and incorporates all documents, instruments or agreements issued or executed in connection therewith or in replacement thereof; and

(iii) means such document, instrument or agreement, or replacement or predecessor thereto, as amended, modified or supplemented from time to time in accordance with its terms and in effect at any given time.

(c) Unless otherwise specified, all references to articles, sections, schedules and exhibits are references to the Articles, Sections, Schedules and Exhibits of this Agreement.

1.3 Recitals. All recitals of the Preamble are incorporated and made a part of this Agreement.

1.4 Captions. All titles of sections of this Agreement have been inserted for reference only and shall in no way affect the interpretation of this Agreement.

ARTICLE II. PROVISION OF WATER

2.1 Agreement to Sell and Purchase.

(a) Subject to all the terms and conditions set forth in this Agreement, and Exhibit “B” - Aqua’s Terms and Conditions for Wholesale Service Outside CCN No. 10294, Aqua agrees to sell and the Purchaser agrees to buy water on a wholesale basis. The water shall be provided at the Point(s) of Delivery for Purchaser’s own use and for distribution to customers served by Purchaser’s water distribution system within Purchaser’s certificated Service Area.

(b) The Wholesale Service provided hereunder is partial requirements only. Purchaser shall, at all times during the term of this Agreement, maintain at least one (1) other source of supply of water. Purchaser’s failure to comply with this provision shall be an Event of Default of a material obligation under the provisions of Article X hereof.

(c) All sales of water from Aqua to Purchaser under this Agreement are subject to any applicable rules of the Lost Pines Groundwater Conservation District. No sales shall take place without any required approval by Lost Pines Groundwater Conservation District.

(d) Unless waived in writing by Aqua, Purchaser shall be required to submit requests for feasibility studies for all Point(s) of Delivery and pay all fees required by Aqua for such studies.

2.2 Quantity of Water to be Delivered. The Maximum Daily Delivery Rate of water to be treated and delivered under this Agreement to any Point(s) of Delivery in any Water Year shall be specifically provided in Exhibit “C” for each Point of Delivery in gallons per minute (GPM).

2.3 Rate of Delivery and Pressure.

(a) Aqua shall deliver water to the Point(s) of Delivery at the Maximum Daily Delivery Rate. Aqua shall install devices to insure compliance with this section, and may restrict deliveries to Purchaser to the Maximum Instantaneous Delivery Rate when appropriate.

(b) Water will be furnished at the Prevailing Pressure of Aqua’s System at the Point(s) of Delivery. Emergency failure of pressure or supply shall excuse Aqua from this provision for such reasonable period of time as may be necessary to restore service.

(c) Aqua’s responsibility and liability for the water being delivered to Purchaser shall cease after said water passes through the Master Meter(s) at the Point(s) of Delivery and enters Purchaser’s system.

(d) Aqua is under no obligation to increase the capacity of its System to satisfy any of the provisions of the Agreement, except as otherwise expressly stated herein.

2.4 Responsibilities of Purchaser and Aqua.

(a) Purchaser is solely responsible for meeting its minimum production, storage, service pump, and pressure maintenance requirements, and any other requirements imposed on Purchaser under Title 30 Texas Administrative Code, Chapters 290 and 291, and any other regulatory requirements. Aqua shall bear no such responsibility to Purchaser or any of Purchaser’s customers.

(b) With the exception of a backflow prevention device specified in Section 2.7, the Master Meter(s) specified in Section 5.1 and any feasibility study related to the provision of

Wholesale Service under this Agreement, Purchaser and Aqua agree to evenly split on a fifty percent / fifty percent (50%/50%) basis all costs associated with each Point of Delivery with the planning, siting, development, design, engineering, procurement, construction and testing of all pipes, interconnects, pumps, mains, trunk lines, junctions, extensions, and other infrastructure, equipment, improvements and facilities, and all easements and right-of-way acquisitions required for Purchaser to connect to Aqua's System at the Point(s) of Delivery described herein to receive the Wholesale Service to be furnished by Aqua under this Agreement or any subsequent amendments hereto. Within ninety (90) Days of the Purchaser receiving the Preliminary Cost Summary ("PCS") from Aqua regarding a Point of Delivery, Purchaser shall pay the full amount indicated on the PCS to Aqua. After each Point of Delivery project has been completed, the final cost of the project will be reconciled with the payments made by Purchaser. Aqua shall reimburse Purchaser in the amount of fifty percent (50%) of the final cost within ninety (90) Days of completion of the Point of Delivery project.

2.5 Water Quality.

(a) The quality of Water to be supplied and delivered by Aqua at the Point(s) of Delivery shall meet the quality criteria prescribed by federal or state law for public water supply and specifically satisfy the TCEQ Drinking Water Standards Governing Drinking Water Quality and Reporting Requirements for Public Water Systems, 30 Tex. Admin. Code Chapter 290, Subchapter F, as currently in effect or as may be amended or superseded from time to time. The water that Aqua delivers to Purchaser shall be of the same quality of water that Aqua delivers to its retail members. Purchaser has satisfied itself that such water is suitable for its needs.

(b) Purchaser shall protect Purchaser's system from cross-connection and contamination under the specifications required by the health standards of the State of Texas. If

Aqua becomes aware of any situation involving Purchaser's system that could reasonable lead to the contamination of Aqua's System or could otherwise compromise the integrity of Aqua's System, Aqua shall immediately notify Purchaser of the situation and request immediate remediation of the situation by Purchaser. If Aqua determines that the seriousness of the situation requires such action, it may immediately, and without prior notice to Purchaser, take such steps to prevent the contamination or compromise of System integrity, including, without limitation, severing connections between Aqua's System and Purchaser and terminating delivery of water to the extent necessary to remedy the problem. If such conditions or problems persist or recur, then Aqua may, in its sole discretion, require the installation of an air gap between Aqua's System and Purchaser. The expenses associated with the installation of such air gap shall be the sole responsibility of Purchaser.

2.6 Sale of Water by Purchaser. Purchaser shall not provide retail water utility service using the water taken from Aqua under this Agreement within Aqua's retail water CCN service area, as identified on Exhibits "A" and "D", and outside of Purchaser's retail wastewater CCN service area as indicated in Exhibit "F", during the Term of this Agreement unless specifically approved in writing by Aqua. Purchaser's provision of retail water service within the area identified on Exhibit "A" as Aqua's retail water CCN service area and not within Purchaser's retail wastewater CCN service area identified as Exhibit "F" shall be considered an Event of Default pursuant to Article X hereof.

2.7 Separation of Systems. A device purchased by Purchaser and approved by Aqua to prevent flow reversal shall be maintained between Aqua's System and Purchaser's system at the Point(s) of Delivery.

2.8 CCN Amendment Application. Purchaser shall submit an application for service to any Point(s) of Delivery and provide Aqua with documentation that identifies the area to be served by Purchaser with the water purchased from Aqua. After approval of the application by Aqua, Aqua shall prepare, file and pursue approval of an application with the PUC to amend Aqua's retail water CCN to exclude the area identified by Purchaser in its application for service. Purchaser shall pay the full cost to Aqua to prepare, file, and pursue the approval of the CCN amendment application at the PUC.

**ARTICLE III.
MAINTENANCE AND CURTAILMENT**

3.1 Planned Outages. By December 1 of any Calendar Year during the Contract term, Aqua shall provide notice to Purchaser of the number and duration of any Planned Outages to be conducted by Aqua during the subsequent Calendar Year that may affect delivery of water to Purchaser. Provided, however, that Aqua shall not schedule more than two (2) such Planned Outages in any given Calendar Year. To the extent reasonably possible, Aqua shall coordinate the timing of any Planned Outage with Purchaser and shall cooperate with Purchaser to minimize the impact of any Planned Outage on the operation and maintenance of Purchaser's system.

3.2 Forced Outages. When a Forced Outage occurs, curtailing the flow of water to the Point(s) of Delivery, Aqua shall notify Purchaser of the existence, nature, and expected duration of the Forced Outage as soon as practical. Aqua shall use its best efforts to ensure that any interruption in the delivery of water to the Point(s) of Delivery due to a Forced Outage shall continue only for so long as reasonably necessary. Aqua shall immediately inform Purchaser of any changes in the nature and expected duration of such Forced Outage.

3.3 Curtailment.

(a) If water supplies or services are curtailed to Aqua's retail members, or if water conservation measures are mandated by a Governmental Authority, Aqua shall impose a like curtailment on deliveries or water conservation measures on Purchaser as provided in Texas Water Code § 11.039. The curtailment Aqua imposes on Purchaser shall be equal in duration to the curtailment imposed on Aqua's retail members.

(b) Aqua will notify Purchaser of the quantity by which Purchaser will reduce its daily take from Aqua, as well as the duration of the requirement that the take be reduced. Purchaser shall cooperate by imposing conservation measures upon its customers.

(c) The reduction to Purchaser's daily take under this Section shall be calculated as follows: (i) determine the total volume of water taken by Purchaser in the same month of the previous calendar year; (ii) divide this monthly volume by the number of days in the month to arrive at an average take per day of that month; (iii) apply the reduction percentage to the average take per day of that month. For example, if it becomes necessary for Aqua to impose a 5% reduction in Purchaser's daily take starting on August 15, 2018, Aqua will determine, based on meter data, the amount of water purchased by Purchaser in August 2017, and divide that number by thirty-one (31) (the number of days in August). The product of that calculation times 5% will be the amount, in gallons, that Purchaser must reduce its daily take until further notice from Aqua. If it becomes necessary for Aqua to impose a curtailment in the year immediately following the Effective Date, Aqua shall use a 5% reduction of the average gallon per person per day amount of 182 gallons for Purchaser in place of the calculation provided above in this section.

3.4 Conservation Measures.

(a) Aqua has in place a Water Rationing Plan in its Tariff as identified as Exhibit “H”. Purchaser is required to abide by the Water Rationing Plan in accordance with Aqua’s Tariff and Aqua’s Terms and Conditions, and is subject to the penalty provisions therein.

(b) Before taking water from Aqua, Purchaser shall either adopt or amend, then enforce water conservation and drought contingency plans that specifically references Aqua’s Water Rationing Plan, and that:

- (i) comply with Title 30 Texas Administrative Code, Chapter 288;
- (ii) will conserve the same or a greater amount of water as under the plans implemented by Aqua, and
- (iii) are approved by TCEQ and provided to Aqua.

Such water conservation and/or drought contingency plans shall be applicable to water taken by Purchaser from Aqua. Purchaser shall submit to Aqua a copy of Purchaser’s water conservation and/or drought contingency plans as originally adopted and as updated from time to time during the term of this Agreement.

3.5 Emergency Notification. Aqua shall notify Purchaser as promptly as possible of all emergency and other conditions of which it becomes aware that may directly or indirectly affect the quality or quantity of the water provided by Aqua, and to provide Purchaser a copy, upon receipt, of all notices received from state or federal agencies or departments having jurisdiction over the installation and operation of public water systems.

3.6 No Statutory Violation for Curtailment. The Parties agree that curtailment of the provision of services under this Agreement is not a violation of the anti-curtailment provision of the Consolidated Farm and Rural Development Act, 7 U.S.C. § 1926(b). If Aqua curtails the

delivery of water under this Agreement it shall not incur any liability under the provisions of this statute.

**ARTICLE IV.
RATES AND COMPENSATION**

4.1 Rates. The Rate for Wholesale Service under this Agreement shall be as provided in Aqua's Terms and Conditions.

4.2 Adjustment to Rates.

(a) The Rates to be paid by Purchaser for services under this Agreement are subject to adjustment by Aqua for each Water Year. Any adjustment made by Aqua shall remain in effect until the next adjustment of Rates which, except as provided in this Section 4.2 and in Section 4.3, shall occur no earlier than twelve (12) months following the date of the last adjustment to Rates.

(b) In determining the Rates to be set hereunder, Aqua may, but need not, consider, but shall not be limited to considering, all costs incurred by Aqua to build, maintain and operate the System, which shall include but not be limited to: operation and maintenance expenses, debt service requirements along with an adequate amount of insurance coverage as determined by Aqua's financial policies now and in the future, depreciation expense, contractual obligations, capital improvements, administrative overhead, supplies, personnel services, and other utility services, and all other costs or expenses directly or indirectly related to Aqua's ability to meet the conditions of this Agreement and determined by Aqua to relate to its performance hereunder.

(c) Aqua shall notify Purchaser of Aqua's proposed Rate adjustments for the ensuing Water Year at least sixty (60) Days prior to the Rate Effective Date. Thereafter, Purchaser may request additional information from Aqua and provide Aqua with any information Purchaser deems pertinent to the level of the Rates to be established by Aqua. The Rate Effective Date will

be the date on which Aqua's Board of Directors adopts the new Rate. The new Rate will be billed to Purchaser effective on the New Rate Billing Cycle.

(d) Aqua may adjust Rates more often than once every twelve months if, in the sole determination of Aqua, additional revenues are needed for the continued prudent operation of the System or to meet Aqua's obligations, and it would not be prudent to wait the full twelve months for a Rate adjustment. In the event Aqua determines to adjust Rates under this paragraph, it shall provide advance notice to Purchaser of at least sixty (60) Days prior to the implementation of such adjustment.

4.3 Pass-through of Rate Adjustments and Other Costs Imposed by Third Parties. The Rates may be adjusted, at any time, for an amount equivalent to any increased charges for any new or revised Governmental Authority restrictions, impositions, rental fees or charges levied, assessed or imposed on Aqua by any new or amended Governmental Authority law or regulation.

4.4 Books and Records. All books and records upon which such Rate adjustment is based shall be made available to Purchaser at the office of Aqua during the regular business hours of Aqua, upon request by Purchaser.

4.5 Reasonableness of Rates. Purchaser agrees that the Rates initially charged by Aqua and the policies defined in this Agreement are just and reasonable, and do not adversely affect the public interest. The Rates charged by Aqua are subject to modification as provided herein. Purchaser agrees that it is reasonable for Aqua to adjust the Rates periodically as provided herein, including the considerations provided in Section 4.2(b), and understands that any adjustments made in accordance with this Agreement, and the considerations provided in Section 4.2(b) are part of the consideration for this Agreement. Notwithstanding any provision to the

contrary, Purchaser does not waive the right to file and pursue an appeal of any increase in Rates proposed or adopted by Aqua that is not in conformance with the terms of this Agreement.

4.6 Rate Case. If a court, the Public Utility Commission, or any federal or state regulatory authority finds that Aqua's Rates or policies for services provided under this Agreement are unreasonable or otherwise unenforceable, Aqua has the option to terminate this Agreement without liability to Purchaser, but Aqua shall provide Purchaser at least six (6) months' notice prior to such termination.

4.7 Pledge of Revenues. Purchaser represents and covenants that all payments to be made by it under this Agreement will be made from the revenues associated with the sale of water purchased from Aqua. Purchaser agrees throughout the term of this Agreement to continuously operate and maintain its water system and to fix and collect such rates and charges for water services to be supplied by its water system as will produce revenues in an amount equal to at least all of its payments under this Agreement.

4.8 Funds on Hand. Purchaser shall use funds on hand to pay Aqua for Wholesale Service provided on a monthly basis.

ARTICLE V. EQUIPMENT AND OPERATION

5.1 Master Meter(s). Aqua shall furnish and install, or caused to be furnished and installed, operate, and maintain a Master Meter(s) at the Point(s) of Delivery as provided by Aqua's current specifications and standards. Purchaser shall be responsible for the cost of the Master Meter(s). The Master Meter(s) shall remain the property of Aqua at all times and shall be located on Aqua's property or on an easement dedicated to Aqua. The amount of water delivered by Aqua through the Point of Delivery to Purchaser shall be determined based upon the data collected at the Master Meter(s) at such location. Purchaser shall install and maintain, and

be responsible for all costs of acquisition, installation, maintenance, and operation of, a Supervisory Control and Data Acquisition (“SCADA”) system at the Master Meter(s) to enable the Master Meter(s) to communicate with Aqua’s System.

5.2 Access to Master Meter(s). Purchaser may have access to the Master Meter(s) only upon approval by Aqua and only for the purpose of verifying its readings. Such approval shall not be unreasonably withheld or delayed, so long as Purchaser provides Aqua with a written request at least forty-eight (48) hours before such access would occur. At no time shall Purchaser be permitted to tamper with, alter, or otherwise adjust any meter or appurtenances at the Point(s) of Delivery or any other component of Aqua’s System. If the Master Meter(s) is located within an area of restricted access, Purchaser shall ensure that Aqua has access at all times.

5.3 Reading of Meter. On a monthly basis, Aqua shall be responsible for reading the meter(s) at the Point(s) of Delivery and submitting an invoice to Purchaser for the quantity of water provided. Aqua shall keep accurate records of all measurements of water required under this Agreement. Upon reasonable request and notice, Purchaser or its agents may have access to the records maintained by Aqua of meter readings associated with the Point(s) of Delivery.

5.4 Regular Testing of Master Meter(s). It shall be the duty of each of the Parties to notify the other Party in the event that the Master Meter(s) is not registering accurately or is malfunctioning, so that the meter can be promptly repaired. Aqua shall test the Master Meter(s) for accuracy at least once each twelve (12) month period, and more often as deemed necessary by Aqua to ensure its accuracy. Aqua shall provide Purchaser with five (5) Business Days’ notice of its intent to perform the annual test of the Master Meter(s), and Purchaser shall have the right to be present when such testing is conducted. In the event the percentage of accuracy of the Master Meter(s) is found to be within the tolerance of one and one-half percent (1.5%) after any

test, such Master Meter(s) shall be deemed to have correctly measured the quantity of water taken under this Agreement. If, however, upon any test of the percentage of accuracy tolerance, such tolerance is found to be in excess of one and one-half percent (1.5%), then such Master Meter(s) shall be adjusted at once to register correctly and accurately, and the amount of water delivered to Purchaser shall be corrected in accordance with the percentage of inaccuracies found by such test for a period extending back to the time when such inaccuracy began, if such time is ascertainable. If such time is not ascertainable, then the correction shall account for a period extending back one-half (1/2) of the time elapsed since the last date of calibration, but in no event further back than a period of six (6) months.

5.5 Additional Testing of Master Meter(s). Purchaser shall have the right to request Aqua to test the Master Meter(s) more frequently than once per Year as contemplated by Section 5.4 herein, but no more frequently than once a month. Upon any such request, Aqua agrees to perform its testing and calibration of the Master Meter(s) in the presence of a representative of Purchaser, and the Parties shall jointly observe any adjustments that are made to the Master Meter(s) in case any adjustments shall be necessary. For such additional testing requests, Aqua shall give Purchaser forty-eight (48) hours' notice of the time when any such testing shall occur. Aqua may proceed with such testing and adjustment, if necessary, in the absence of any representative of Purchaser. Purchaser shall pay the cost of any additional test for a Master Meter if the test shows that such Master Meter is accurate [within one and one-half percent (1.5%) registration], but Aqua shall pay the costs of the additional test for such if the results indicate that such Master Meter is not accurate [in excess of one and one-half percent (1.5%) registration].

5.6 Maintenance of Master Meter(s). Except as provided in Section 5.5 above, all maintenance, testing and/or repairs or replacement of the Master Meter(s) and related appurtenances at the Point(s) of Delivery shall be made by Aqua. Aqua shall provide repairs to the Master Meter(s) in a prompt and timely manner. If Aqua cannot make such repairs in a timely manner, then Purchaser shall have the option of making such repairs at its own expense, subject to the prior approval and post-inspection of the repairs by Aqua.

**ARTICLE VI.
POINT(S) OF DELIVERY**

6.1 Location of and Cost Responsibility for Point(s) of Delivery. Each Point of Delivery for Water delivered and taken under this Agreement is located as described in Exhibit "C" hereto. Purchaser agrees to be responsible for all costs associated of the acquisition, construction, and installation of each Point(s) of Delivery, any associated metering station(s), and any line extension(s) from Aqua's existing water infrastructure to the Point(s) of Delivery that are necessary to enable Aqua to deliver water to the Point(s) of Delivery. Aqua shall own any water line extensions that connect Aqua's water distribution infrastructure to the Point(s) of Delivery and such line extensions shall be part of Aqua's System. Purchaser shall own any water line extensions that connect Purchaser's water distribution infrastructure to the Point(s) of Delivery and such line extensions shall be part of Purchaser's System.

6.2 Relocation of Point(s) of Delivery. The Parties may agree in writing to relocate any Point of Delivery or to add additional Points of Delivery as necessary. Any such relocation and/or each such additional Point(s) of Delivery will be reflected by amendment to this Agreement and to Exhibit "C".

6.3 Acquisition of Necessary Easements. Aqua will acquire the necessary easements, through either negotiation or eminent domain, if required, and Purchaser will pay the full cost of

acquiring the necessary easements and rights-of-way in which any of Aqua's System is located, including any such easements as become necessary for any additional Point(s) of Delivery.

**ARTICLE VII.
OWNERSHIP OF WATER AND FACILITIES**

7.1 Transfer of Ownership. As between the Parties, Aqua shall be: (i) deemed to have exclusive care, custody, and control for all water up to the Point(s) of Delivery; and (ii) responsible for all Losses required to deliver water to the Point(s) of Delivery. Purchaser shall be: (i) deemed to take exclusive care, custody, and control of all water from and after the Point(s) of Delivery; and (ii) responsible for all Losses associated with all water from and after the Point(s) of Delivery.

7.2 No Ownership of Facilities.

(a) Purchaser obtains no ownership, leasing, or management interest in any of Aqua's System by or through this Agreement or payment of any Rate set forth herein.

(b) Purchaser shall be responsible for maintenance and repairs on all facilities located downstream of the Point(s) of Delivery. Aqua and Purchaser will use all reasonable efforts to prevent waste through line leakages or breaks.

**ARTICLE VIII.
BILLING AND PAYMENT**

8.1 Meter Readings.

(a) Aqua shall send a bill to Purchaser once per month setting forth the quantity of water delivered to Purchaser as determined by Aqua's periodic readings of the Master Meter(s) installed at the Point(s) of Delivery. Purchaser shall pay the total amount owed to Aqua by the due date on each bill. Penalties for late payment shall be imposed according to the provisions of Aqua's Terms and Conditions.

(b) Aqua shall also invoice Purchaser for additional charges, if any, as provided in this Agreement. These invoices shall be due and payable by Purchaser within fifteen (15) Days after receipt.

8.2 Breach for Failure to Timely Pay. Should Purchaser fail to tender payment to Aqua by the due date, the bill shall be considered delinquent, unless contested in good faith as provided herein. In such event, Aqua shall notify Purchaser of such delinquency in writing. If Purchaser fails to make payment of the delinquent billing within thirty (30) Days from the due date, then Aqua may, at its discretion, temporarily terminate service to Purchaser until payment is made. If such delinquency is not cured within thirty (30) Days after temporary termination of service, Purchaser will be in breach of a material term and/or condition of this Agreement and Aqua may terminate this Agreement as provided herein.

8.3 Disputed Bills. If Purchaser in good faith disputes the amount of the bill, Purchaser shall submit such dispute in writing to Aqua no later than thirty (30) Days after receipt of the invoice, and shall timely make the disputed payment or payments. If it is subsequently determined by agreement or court decision that the disputed amount paid by Purchaser should have been less, or more, Aqua shall promptly revise the monthly invoice amount in a manner that Purchaser or Aqua will recover the amount due plus interest, with interest being calculated at an annual rate of five percent (5%).

ARTICLE IX. FORCE MAJEURE

9.1 Procedure for Calling Force Majeure.

(a) Notice of Force Majeure. The Affected Party shall give prompt notice to the other Party of any event or circumstance of Force Majeure as soon as reasonably practicable after becoming aware of such event or circumstance. Each notice served by an Affected Party to

the other Party pursuant to this Subsection 9.1(a) shall specify the event or circumstance of Force Majeure in respect of which the Affected Party is claiming relief. Noncompliance by the Affected Party with the procedure specified in this Subsection 9.1(a) shall relieve the other Party from accepting the Affected Party's claim of Force Majeure until the Affected Party so complies, and the Affected Party shall not be excused from performance of any obligation under this Agreement until it so complies.

(b) Obligations During Pendency of Force Majeure. The Affected Party shall, by reason of any event or circumstance of Force Majeure in respect of which it has claimed relief under Subsection 9.1(a):

(i) use its best efforts to mitigate the effects of such Force Majeure and to remedy any inability to perform its obligations hereunder due to such event or circumstance as promptly as reasonably practicable;

(ii) furnish timely reports to the other Party regarding the progress in overcoming the adverse effects of such event or circumstance of Force Majeure; and

(iii) resume the performance of its obligations under this Agreement as soon as is reasonably practicable after the event or circumstance of Force Majeure is remedied or such event or circumstance, or the effect thereof on the Affected Party, ceases to exist.

(c) Resumption of Performance. When the Affected Party is able, or would have been able if it had complied with its obligations under this Article IX, to resume the performance of any or all of its obligations under this Agreement affected by the occurrence of an event or circumstance of Force Majeure, then the period of Force Majeure relating to such event or circumstance shall be deemed to have ended.

9.2 Effects of Force Majeure.

(a) Relief From Obligation of Performance. Provided it has complied with its obligations under Section 9.1, the Affected Party shall be relieved from any liability for the non-performance of its obligations under this Agreement where and to the extent that such non-performance is attributable directly to the event or circumstance of Force Majeure asserted.

(b) Relief From Obligation of Counterperformance. The non-Affected Party shall not be required to perform or resume performance of its obligations to the Affected Party corresponding to the obligations of the Affected Party excused by reason of Force Majeure.

9.3 Limitations on Force Majeure.

(a) Scope and Duration. No event or circumstance of Force Majeure shall relieve the Affected Party of any obligation that accrued prior to the commencement of such event or circumstance of Force Majeure, and the suspension of the Affected Party's performance shall be no longer in duration and no greater scope than is required by the event or circumstance of Force Majeure.

(b) No Extension of Term. Except as agreed by the Parties, no suspension, delay or failure of performance caused by a Force Majeure event shall extend this Agreement beyond the Term.

**ARTICLE X.
DEFAULT AND TERMINATION**

10.1 Event of Default. It shall be an Event of Default by either Party if such Party shall breach any material covenant, obligation, representation, or warranty of such Party under this Agreement, which breach remains uncured for a period of thirty (30) Days after written notice from the non-breaching Party of the existence of such breach; provided, that the non-breaching Party shall extend the cure period for any such breach (and thus no Event of Default shall occur)

if the nature of the default is such that it cannot reasonably be remedied within such thirty (30) Day period, and the breaching Party has diligently commenced corrective action within such thirty (30) Day period and is diligently pursuing such correction thereafter.

10.2 Remedies. If an Event of Default has occurred and is continuing, the non-defaulting Party shall be entitled to the following remedies, which shall be cumulative:

- (a) injunctive relief;
- (b) specific performance;
- (c) the right to cure the other Party's default;
- (d) suspension of delivery of water hereunder;
- (e) termination of this Agreement;
- (f) any of the remedies afforded in this Agreement; and
- (g) any other remedies permitted at law or in equity, including damages.

Provided, that Aqua shall not be responsible in damages for any failure to supply water or for any interruption of the supply of water under this Agreement.

10.3 Aqua Right to Suspend or Terminate. Aqua shall have the right, for its sole convenience and without cause, to terminate or suspend, in whole or in part, Aqua's performance of any of its duties or obligations under this Agreement, upon sixty (60) Days prior written notice to Purchaser, in the event that:

- (a) Aqua, through no fault or negligence of its own, loses any Permit or other authorization from a Governmental Authority that is required by Aqua to perform its obligations under this Agreement; or
- (b) Aqua, after due diligence, is unable to obtain any necessary Permit, Permit amendment, or other necessary authorization from a Governmental Authority or is subject to an

action by a Governmental Authority that reduces its permitted quantity of surface water or groundwater that is necessary to perform its respective duties under this Agreement.

10.4 Termination for Continued or Multiple Force Majeure. Either Party shall have the right (but not the obligation) to terminate this Agreement upon seven (7) Days prior written notice to the other Party in the event the suspension of any material obligation of the Affected Party resulting from one or more events of Force Majeure continues for a period of more than three (3) consecutive months or for a period of more than three (3) months in the aggregate during a one (1) year period; provided that the Affected Party shall only be entitled to terminate this Agreement under this Section 10.4 if it has met its obligations under Section 9.1 (Procedures for Calling Force Majeure). The non-affected Party may, but shall not be obligated to, extend either such period for such additional period as it deems appropriate, if the Affected Party is exercising due diligence in its efforts to cure the Force Majeure event.

10.5 Effective Date of Termination for Continued or Multiple Force Majeure. Upon receipt of any notice of termination delivered pursuant to this Article X, this Agreement shall terminate, effective immediately, and will be of no further force or effect, except with respect to: (i) rights and obligations of the Parties arising during or relating to any period prior to termination, including, in the case of termination for any Event of Default, all of the damages incurred by the non-defaulting Party in connection with such Event of Default, which shall include but not be limited to, Aqua's stranded investment incurred in anticipation of providing the services to Purchaser throughout the term of this Agreement; and (ii) the covenants and obligations of the Parties set forth in this Agreement intended to survive the expiration or termination of this Agreement, which shall survive the expiration or earlier termination of this Agreement as

expressly provided in this Agreement, or if no express survival period is provided for, then until such obligations have been satisfied, or, if later, pursuant to any applicable statute of limitations.

10.6 Mutual Termination by Parties. This Agreement may be terminated upon agreement of Aqua and Purchaser as evidenced in writing. The termination shall take effect upon the date agreed to in writing by Aqua and Purchaser.

ARTICLE XI. DISPUTE RESOLUTION

11.1 Attempt to Resolve. The Parties agree that, prior to instituting any lawsuit or other proceeding arising from a dispute under this Agreement, the Parties will first attempt to resolve the dispute by taking the following steps:

(a) A written notice substantially describing the nature of the dispute shall be delivered by the dissatisfied Party to the other Party, which notice shall request a written response to be delivered to the dissatisfied Party not less than five (5) Days after receipt of the notice of dispute.

(b) If the response does not reasonably resolve the dispute, in the opinion of the dissatisfied Party, the dissatisfied Party shall give notice to that effect to the other Party whereupon each Party shall appoint a person having authority over the activities of the respective Parties who shall promptly meet, in person, in an effort to resolve the dispute.

(c) If those persons cannot or do not resolve the dispute, then the Parties shall each appoint a person from the highest tier of managerial responsibility within each respective Party, who shall then promptly meet, in person, in an effort to resolve the dispute.

11.2 Non-Binding Mediation for Matters not under PUC Jurisdiction. In the event the measures provided for in Section 11.1 are not successful in resolving the dispute for matters not under the PUC's jurisdiction, Aqua and Purchaser shall enter into non-binding mediation in an

attempt to resolve the dispute prior to commencing litigation. Aqua and Purchaser shall mutually select an impartial individual to serve as mediator. In the event the Parties are unable to agree on an individual to serve as the mediator, either Party may apply to a District Judge for Bastrop County who shall be empowered to designate an individual to serve as the mediator.

11.3 Rates Not Subject to Mediation. Notwithstanding Sections 11.1 and 11.2, and in accordance with Sections 4.5 and 4.6, neither the Rates to be paid hereunder, nor the provisions for payments of said Rates, shall be subject to mediation unless ordered by the PUC.

11.4 Costs of Mediation. Each Party shall bear its own costs and expenses associated with any mediation or appeal of any provision of this Agreement.

ARTICLE XII. LIABILITY

12.1 Limitation on Liability and Responsibility / Hold Harmless. Neither Aqua nor Purchaser shall be liable or responsible to the other for any claims or damages of any kind for injury to or death of any person or persons, for damage to or loss of property arising out of or attributed directly or indirectly to operations, acts or failures to act by the other and shall hold the other party harmless for any such claims, damages, losses, injuries or deaths.

12.2 General Limitation on Liability. Notwithstanding any other provision of this Agreement, in no event shall either Party be liable to the other under any theory of tort, contract, strict liability, or other legal or equitable theory, whether by way of indemnity or otherwise, for any lost profits, exemplary, punitive, special, incidental, indirect, or consequential damages of the other Party.

ARTICLE XIII.
REPRESENTATIONS, WARRANTIES AND COVENANTS

13.1 Aqua Representations and Warranties. Aqua hereby represents and warrants to Purchaser, as of the date hereof, as follows:

(a) Aqua is a retail public utility holding a CCN and has all requisite power and authority to enter into and to perform its obligations hereunder, and to carry out the terms hereof and the transactions contemplated hereby.

(b) This Agreement has been duly executed and delivered on behalf of Aqua by the appropriate officials of Aqua, and constitutes the legal, valid and binding obligation of Aqua, enforceable against Aqua in accordance with its terms except as the enforceability thereof may be limited by: (i) bankruptcy, insolvency, reorganization, moratorium, or other similar laws affecting the enforcement of creditors' rights generally; and (ii) general equitable principles.

(c) The execution, delivery and performance of this Agreement by Aqua have been duly authorized under the bylaws and all other applicable Requirements of Law of Aqua and will not contravene any provision of or constitute a default under any other agreement or instrument to which Aqua is a party or by which Aqua or its property may be bound, and do not conflict with any Requirement of Law currently in force and applicable to Aqua.

(d) There is no legislation, litigation, action, suit, proceeding, or investigation pending or (to the best of Aqua's knowledge) threatened, against Aqua, whether related to the operation of any facility that will supply water under this Agreement, or otherwise, before or by any Governmental Authority which, if adversely determined, individually or in the aggregate: (i) could adversely affect the performance by Aqua of its obligations hereunder; (ii) could have a material adverse effect on the condition (financial or otherwise), business or operations of Aqua;

or (iii) questions the validity, binding effect or enforceability thereof or of this Agreement, any action taken or to be taken pursuant hereto or any of the transactions contemplated hereby.

13.2 Purchaser Representations and Warranties. Purchaser represents and warrants to Aqua, as of the date of this Agreement, as follows:

(a) Purchaser is a retail public utility holding a CCN and is authorized to provide retail water utility service to the areas within its CCN, and has all requisite power and authority to enter into and to perform its obligations hereunder, and to carry out the terms hereof and the transactions contemplated hereby.

(b) This Agreement has been duly executed and delivered on behalf of Purchaser, and constitutes the legal, valid and binding obligation of Purchaser, enforceable against Purchaser in accordance with its terms except as the enforceability thereof may be limited by: (i) bankruptcy, insolvency, reorganization, moratorium or other similar laws affecting the enforcement of creditors' rights generally; and (ii) general equitable principles.

(c) There is no legislation, litigation, action, suit, proceeding or investigation pending or (to the best of Purchaser's knowledge) threatened, against Purchaser or related to Purchaser's activities by any court, administrative agency, arbitrator or governmental authority, body or agency which, if adversely determined, individually or in the aggregate: (i) could adversely affect the performance by Purchaser of its obligations hereunder; (ii) could have a material adverse effect on the condition (financial or otherwise), business or operations of Purchaser; or (iii) questions the validity, binding effect or enforceability thereof or of this Agreement, any action taken or to be taken pursuant hereto or any of the transactions contemplated hereby.

(d) No officer or employee of Aqua has been or will be compensated in any manner with respect to directly or indirectly bringing the Parties together, agreement negotiations, or the

entering into this Agreement. In no event will Purchaser pay a fee to or in any other manner compensate any of Aqua's board members, officers, or employees in connection with the acceptance of this Agreement. A breach of this Subsection 13.2(d) shall result in automatic and immediate termination of this Agreement and shall be an Event of Default.

**ARTICLE XIV.
TERM**

This Agreement shall be effective on the date of the last to execute below, the Effective Date of this Agreement, and shall remain in force and effect for a period of _____ () years from the Effective Date hereof. However, this Agreement may be terminated by either Party in accordance with Article X of this Agreement. As provided in Article X, earlier termination by Purchaser shall render Purchaser liable in damages for repayment of Aqua's stranded investment incurred in anticipation of providing services to Purchaser throughout the term of this Agreement. Purchaser agrees that Aqua has no obligation to provide it with water after the termination of this Agreement. Unless either Purchaser or Aqua provides the other party with its written intent to not renew this Agreement not later than one (1) year prior to the date of the expiration of the initial term of this Agreement, this Agreement shall automatically renew for an additional _____ () year period and the Agreement's terms and conditions shall remain in effective for the length of the additional _____ () year period.

**ARTICLE XV.
MISCELLANEOUS**

15.1 Assignment. This Agreement shall be binding upon and inure to the benefit of the Parties and their legal successors, but the Agreement shall not be otherwise assignable in whole or in part by either Aqua or Purchaser without first obtaining the written consent of the other.

15.2 Governing Law and Venue. The Constitution and the laws of the State of Texas and the decisions of its courts shall govern with respect to any question or controversy that may arise hereunder. All amounts due under this Agreement, including but not limited to payments due under this Agreement or damages for breach of this Agreement, shall be paid and be due in Bastrop County, Texas, which is the county in which the principal administrative offices of Aqua are located. It is specifically agreed that Bastrop County, Texas, is a principal place of performance of this Agreement. Venue for any actions arising under this Agreement shall lie exclusively in the courts of Bastrop County, Texas.

15.3 Notices. Unless the context requires immediate notice, which may be provided by telephone, any notice, request or other communication required by this Agreement between the Parties regarding the Agreement shall be given in writing and shall be deemed to have been given to the other Party upon either of the following dates:

(a) The date of the mailing thereof, as shown by a post office receipt, if mailed to the Party by registered or certified mail at the latest address specified for such other Party in writing;

or

(b) The date of the receipt thereof by such other Party if not so mailed by registered or certified mail. Notice shall be made to Aqua as follows:

General Manager
Aqua Water Supply Corporation
P.O. Drawer P
415 Old Bastrop Highway
Bastrop, Texas 78602

With copy to: Ty Embrey
Lloyd Gosselink, P.C.
1800 Congress Avenue, Suite 1900
Austin, Texas 78703

Notice to Purchaser shall be made as follows:

City of Bastrop
P.O. Box 427
Bastrop, Texas 78602
Attn: City Manager

With copy to: Alan Bojorquez
Bojorquez Law Firm
12325 Hymeadow Drive
Suite 2-100
Austin, Texas 78750

(c) The Parties shall have the right from time to time to change their respective addresses by giving written notice to the other Party.

15.4 No Waiver of Rights.

(a) No waiver by either Party of any default or defaults by the other Party in the performance of any of the provisions of this Agreement shall operate or be construed as a waiver of any other or further default or defaults whether of a like or different character or shall be effective unless in writing, duly executed by a duly authorized representative of the Party waiving any such default.

(b) Neither the failure by a Party to insist on any occasion upon the strict performance of the terms, conditions, and provisions of this Agreement, nor time or other indulgence granted by one Party to the other, shall act as a waiver of such breach.

15.5 Severability. In case any one or more of the Articles, Sections, provisions, clauses, or words of this Agreement shall for any reason be held to be invalid, unenforceable or unconstitutional, such invalidity, unenforceability or unconstitutionality shall not affect any other Articles, Sections, provisions, clauses, or words of this Agreement, and it is intended that this Agreement shall be severable and shall be construed and applied as if such invalid or unconstitutional Article, Section, provision, clause or word had not been included herein.

15.6 Entire Agreement. This Agreement contains all of the agreements between the Parties on the subjects contained herein. As of the Effective Date of this Agreement, this Agreement shall replace any and all prior agreements between the Parties, both oral and written, with regard to the subject matter.

15.7 Amendments. This Agreement may be changed or modified at any time by a written instrument signed by both Parties and only after having obtained approval from the governing bodies of Aqua and Purchaser. Any amendments to any exhibits attached hereto that become necessary from amendments to this Agreement shall be done and be made effective contemporaneously with any amendments to this Agreement. No change or modification shall be made to this Agreement that will affect adversely the prompt payment, when due, of all monies to be paid by Purchaser under the terms of the contract or that will adversely affect the tax-exempt status of any tax-exempt obligations issued by Aqua or Purchaser. The foregoing notwithstanding, the Parties hereto agree to use their best efforts to modify this Agreement if the Internal Revenue Service determines that a failure to do so would adversely affect the tax-exempt status of any outstanding tax-exempt obligations issued by Aqua or Purchaser.

15.8 Cooperative Drafting. This Agreement is the product of a cooperative drafting effort by the Parties and shall not be construed or interpreted against either Party solely on the basis that one Party or its attorney drafted this Agreement or any portion of it.

15.9 Counterparts. This Agreement may be executed in counterparts, each of which shall be an original and all of which shall constitute but one and the same instrument. The Parties may execute this Agreement and all other agreements, certificates, instruments and other documents contemplated by this Agreement and exchange the counterparts of such documents by means of facsimile transmission, and the Parties agree that the receipt of such executed counterparts shall

be binding on such Parties and shall be construed as originals. Thereafter, the Parties shall promptly exchange original versions of this Agreement and all other agreements, certificates, instruments and other documents contemplated by this Agreement that were executed and exchanged by facsimile transmission.

15.10 Third Party Beneficiaries. Nothing in this Agreement is intended or shall be construed to confer upon, or to give to, any legal Person other than the parties, any right, remedy, or Claim under or by reason of this Agreement. Any covenants, terms, conditions, and provisions in this Agreement by and on behalf of the Parties shall be for the sole and exclusive benefit of the Parties. Nothing in this Agreement is intended to interfere with any agreement of any Party with a third party.

15.11 Certified Copy to PUC. Aqua shall provide the PUC with a certified copy of the executed wholesale water supply contract with Purchaser within thirty (30) Days after the date of execution of the Contract in accordance with Texas Water Code Section 13.144.

15.12 Deadlines. To the extent that the date for any payment or notice due hereunder by either Party shall fall on a Day that is not a Business Day, such deadline for payment or notice, as the case may be, shall be automatically extended to the next following Business Day.

IN WITNESS WHEREOF, the parties have executed this Agreement as indicated below.

AQUA

PURCHASER

By: _____
Alan David McMurry
General Manager

By: _____
Lynda Humble
City Manager

Date: _____

Date: _____

Attest: _____
Ann Franklin
City Secretary

Exhibit A AQUA WSC CCN

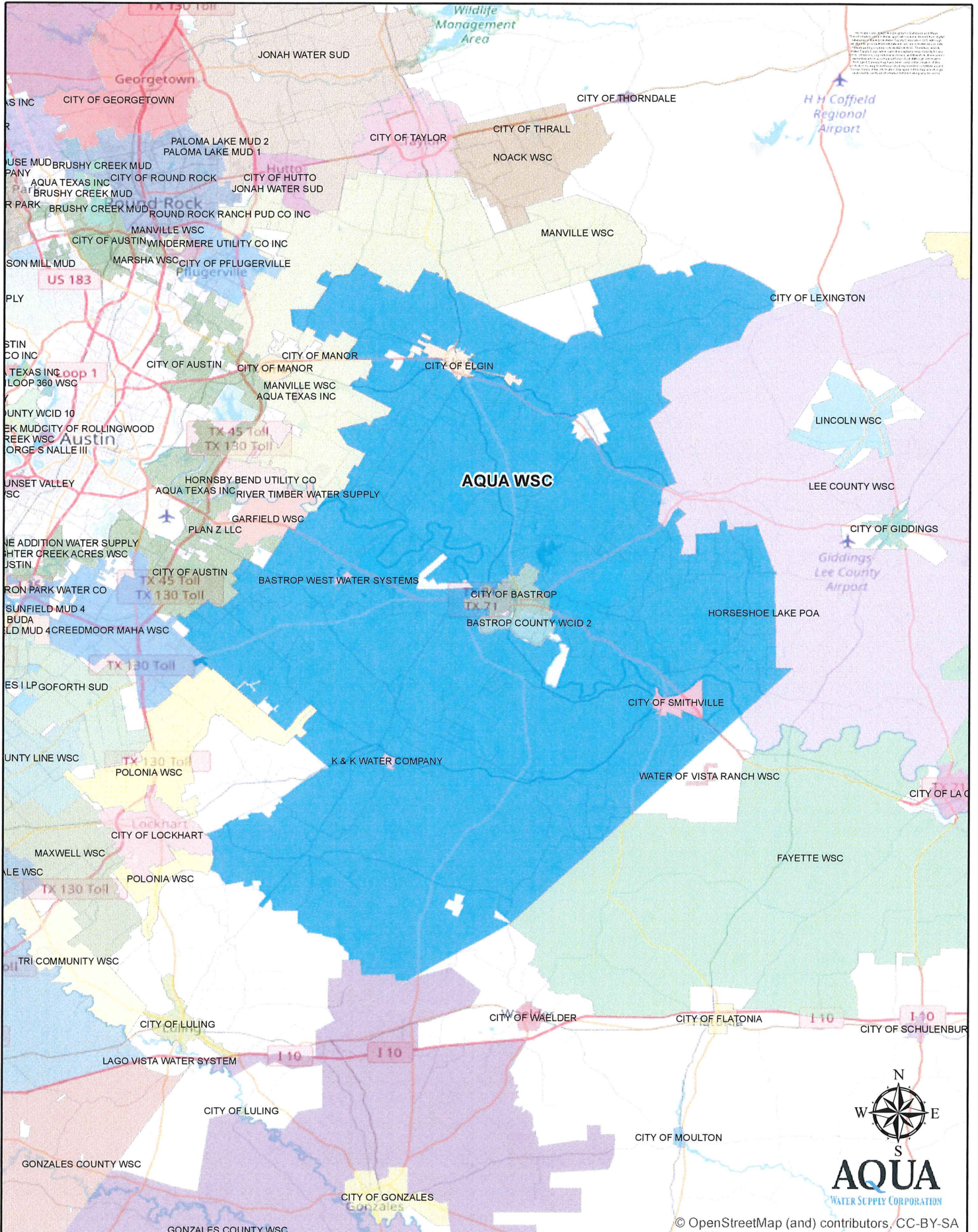

Exhibit B

**AQUA WATER SUPPLY CORPORATION
TERMS AND CONDITIONS FOR WHOLESALE
SERVICE**

City of Bastrop

November 2018

SECTION 1.0
DEFINITIONS

“Aqua” means Aqua Water Supply Corporation as represented by its Board of Directors.

“Aqua’s Engineer” means a person or firm licensed by the State of Texas and engaged by Aqua to provide engineering consulting services to Aqua.

“Aqua’s System” means collectively all of Aqua’s production, distribution, and transmission facilities, including, without limitation, wells, ground storage reservoirs, pump stations, elevated storage tanks, water transmission and distribution lines connecting any of the aforementioned facilities, and other properties or interest therein wherever located for the production, distribution, and transmission of water.

“Bastrop” means the City of Bastrop, Texas.

“Bastrop’s Engineer” means a person or firm licensed by the State of Texas and engaged by the City of Bastrop to provide engineering consulting services to Bastrop.

“Bastrop’s System” means collectively all of Bastrop’s production, distribution, and transmission facilities, including, without limitation, wells, ground storage reservoirs, pump stations, elevated storage tanks, water transmission and distribution lines connecting any of the aforementioned facilities, and other properties or interest therein wherever located for the production, distribution, and transmission of water.

“Board of Directors” or “Board” means the duly elected members of the Board of Directors of Aqua Water Supply Corporation.

“Capacity Charge” means the cost to have water service available under a Wholesale Service Agreement.

“Commodity Replacement Charge” means the charge assessed against Bastrop under a Wholesale Service Agreement for the purpose of replacing the water supply contracted for sale to Bastrop.

“Cost of Construction” means all expenses associated with constructing, installing and placing a facility into operation including, but not limited to, planning, engineering, clearing, surveying, legal, land acquisition, acquisition of rights-of-way, the construction contract, and the like.

“Maximum Daily Delivery Rate” means the maximum rate at which Aqua will deliver water to a Bastrop under a Wholesale Service Agreement in one twenty-four (24) hour period.

“Monthly Customer Charge” means the cost to have water available at a meter.

“Service Area” means that area to which Aqua may lawfully provide water service, whether within or outside the area described by the Certificate of Convenience and Necessity held by Aqua.

“Usage Charge” means the charge billed for water delivered through a metered point of delivery.

“Wholesale Service” means wholesale water service provided to a retail public utility, as defined by the Texas Water code, located outside of Aqua’s service area. Water provided under Wholesale Service shall be partial requirements only, pursuant to a Wholesale Service Agreement between Aqua and Bastrop. Such water shall be submetered for resale by the Bastrop within Bastrop’s service area. Aqua will not be the retail service provider to the customers of Bastrop.

SECTION 2.0
WHOLESALE SERVICE RATE SCHEDULE

Section 2.01 – Water Rates

The monthly charge for Wholesale Service shall be the sum of the Capacity Charge, the Usage Charge, and the Commodity Replacement Charge.

The Capacity Charge is a fixed charge assessed against the contractual Maximum Daily Delivery Rate (0.75 MGD) in the amount of \$45,000 per million gallons of water per day (“MGD”). Such amount shall be payable in advance on a monthly basis.

The Usage Charge is applicable to all water actually delivered to Bastrop by Aqua pursuant to the Wholesale Service Agreement in the amount of \$0.75 (seventy five cents) per 1,000 gallons delivered.

The Commodity Replacement Charge is a variable charge applicable to all water actually delivered to Bastrop in the amount of \$0.20 (twenty cents) per 1,000 gallons delivered.

Lost Pines Groundwater Conservation District Assessment

The assessments established by the Lost Pines Groundwater Conservation District shall be collected from each member.

Section 2.02 – Other Fees

After receipt of the Feasibility Study, Aqua will determine the size meter assembly required to meet the request. Aqua shall also calculate the appropriate Meter Set Fee associated with the requested meter. The Tap Fee shall include the actual cost for purchasing and installing the appropriate size and type meter and any flow controlling device and backflow prevention device as determined to be necessary by Aqua. The Membership Fee for Wholesale Service shall be \$100.00.

Bastrop shall be responsible for all fees and expenses incurred by Aqua associated with Aqua applying for, and obtaining, all permits required by a groundwater conservation district for the transport of water out of such district for the benefit of Bastrop and all fees and expenses, such as attorneys’ fees, estimated to be incurred by Aqua in negotiating and drafting a Wholesale Service Agreement.

A deposit of \$2,500.00 to cover expected fees and expenses shall be submitted to Aqua by Bastrop at the time Bastrop submits its request for a Wholesale Service Agreement to Aqua. Aqua shall issue an invoice to Bastrop for all such fees and expenses incurred in excess of the deposit, and Bastrop shall promptly submit payment in full to Aqua. The failure of Bastrop to timely reimburse Aqua for such fees and expenses will be cause for Aqua to reject Bastrop's request for a Wholesale Service Agreement or to abate consideration of such request pending receipt of payment from Bastrop. If such permits are required, the issuance of such permits shall be a condition precedent to Aqua providing a Wholesale Service Agreement to Bastrop.

Section 2.03 -- Miscellaneous Fees and Requirements for Service

a.	<u>Reconnection Fees</u>	
	Base Reconnection Fee	\$60.00
	Past Due Balance	As applicable

The above Reconnection Fee must be paid before service can be restored to Bastrop who has been disconnected. A Base Fee of \$60.00 shall be charged for all reconnections. At service locations where equipment tampering or an unauthorized connection has resulted in forfeiture of membership and tap rights, the former member shall be required to make full payment of the Membership Fee and the Tap Fee in effect at the time service is requested. Additionally, the former member shall be required to make full payment of applicable Equipment Damage Fees.

b. Late Charge

A 10% penalty will be added for payment received after the 10th day of the month. Failure to pay by the 10th, may require disconnection. The penalty on delinquent bills may not be applied to any balance to which the penalty was applied in a previous billing.

c.	<u>Returned Check Charge</u>	\$ 35.00
----	------------------------------	----------

SECTION 3.0
SERVICE RULES AND REGULATIONS

Section 3.01 – Application for Wholesale Service

Wholesale Service is provided pursuant to a long-term Wholesale Service Agreement, after (i) receipt of an application for Wholesale Service, and (ii) a determination is made by Aqua that Wholesale Service is available to Bastrop. This service may be provided by Aqua in Aqua's sole determination, taking into consideration the proposed place of use of the water, the furtherance of the goals of regionalization, the optimal use of Aqua's infrastructure, and other policies and guidelines adopted by Aqua from time to time. Aqua is under no obligation to provide Wholesale Service.

Entities meeting the following minimum qualifications may apply for Wholesale Service. However, meeting the following minimum qualifications in no event entitles any entity to become a purchaser of Wholesale Service. Minimum qualifications for Bastrop for Wholesale Service include, but are not limited to, the following:

1. Bastrop is a retail public utility as defined by the Texas Water Code that either (i) holds a valid Certificate of Convenience and Necessity (“CCN”) for the provision of retail water utility service issued by the Texas Commission on Environmental Quality, its predecessors or successors, or (ii) is statutorily exempt from the requirement that it hold a CCN in order to provide retail water utility service.
2. Bastrop’s service area is adjacent to the CCN held by Aqua.
3. Bastrop demonstrates to Aqua’s satisfaction its creditworthiness and ability to perform financially under the terms of the Wholesale Service Agreement. Unless Aqua agrees otherwise, such demonstration shall be made by Bastrop providing to Aqua an irrevocable letter of credit in the amount of six (6) months’ estimated billings by Aqua under the requested Wholesale Service Agreement. The letter of credit shall be continuously valid for the term of the Agreement, shall be issued by a bank authorized to do business in the State of Texas, and shall identify Aqua as the beneficiary.
4. Bastrop has other water supplies available and will not be a full-requirements wholesale customer of Aqua.

Bastrop must present a complete application for Wholesale Water Service.

If the sale of water by Aqua to Bastrop requires a transport permit from an underground water conservation district, then upon request by Bastrop, Aqua will submit an application for a Transport Permit at Bastrop’s expense. By accepting Bastrop’s application for Wholesale Water Service, and by submitting an application for a Transport Permit, Aqua makes no warranty or guarantee to Bastrop that the Transport Permit application will be successful.

Section 3.02 -- Billing

Water bills shall be rendered monthly unless service is terminated before the end of a billing cycle. Service initiated less than one week before the next billing cycle may be billed with the following month's bill.

Payment is considered late if not received at Aqua’s office or postal address by the 10th of the month. A 10% penalty will be added for payment received after the 10th day of the month. Failure to pay by the 10th may result in disconnection.

Section 3.03 -- Service Disconnection

Wholesale service to Bastrop may be disconnected if a bill has not been paid and proper notice has been given.

Proper notice shall consist of a separate mailing or hand delivery at least five (5) days prior to a stated date of disconnection, with the words “termination notice” or similar language prominently displayed on the notice. If applicable, the notice must also list the past due balance.

Service may be disconnected after proper notice for any of the following reasons:

1. Failure to pay a delinquent account or to comply with a deferred payment agreement;
2. Willful violation of a usage rule when that violation interferes with another member's service;
3. Other reasons set forth in the Wholesale Service Agreement.

Service may only be disconnected without notice:

1. When a known dangerous condition exists, for as long as the condition exists;
2. When service is established through meter bypassing, an unauthorized connection or unauthorized reconnection; or
3. In instances of tampering with Aqua's meter or equipment.

Section 3.04 -- Forfeiture of Membership

If Wholesale Service has been disconnected for nonpayment for more than 365 consecutive days or if Aqua's equipment has been tampered with or water is taken by means of an unauthorized connection, or both:

Bastrop shall forfeit all rights and privileges of membership;

Bastrop shall forfeit all connection and tap rights;

The meter shall be removed; and

The Point of Delivery shall be sealed.

Section 3.05 -- Limitation of Liability

Aqua shall not be liable for any damages, including without limitation, direct damages, special damages, incidental damages, consequential damages, or loss of profit or revenue, resulting from failures or interruptions of water supply occurring because of maintenance of Aqua's water distribution system or that are occasioned by causes beyond the control of Aqua. Aqua shall not be liable in any event for consequential damages.

Section 3.06 -- Litigation

These Terms and Conditions shall be construed under and in accordance with the laws of the State of Texas. All obligations of the parties created under these Terms and Conditions shall be performable in Bastrop County, Texas. All payments required to be made to Aqua under the Wholesale Service Agreement shall be made at Aqua's offices in Bastrop County, Texas. Bastrop County, Texas shall be the exclusive place of venue for any disputes arising under the Wholesale

Service Agreement. In the event Aqua is required to retain an attorney to enforce the Wholesale Service Agreement or any of the Terms and Conditions or to collect amounts owed, Bastrop shall be responsible for all costs incurred by Aqua, including reasonable attorneys' fees.

SECTION 4.0 -- WATER RATIONING PLAN

Aqua has enacted a Water Rationing Plan as set out in its Tariff and Water Conservation Plan. Prior to service by Aqua, Bastrop is required to adopt Aqua's Water Rationing Plan and Water Conservation Plan, or a plan that is substantially similar that has been approved by the Texas Commission on Environmental Quality. Aqua will notify Bastrop of any revisions to the Water Rationing Plan and Water Conservation Plan and Bastrop shall ensure that their plan conforms with such amendments within thirty (30) days of notification.

Exhibit C

Description(s), Map(s) of Point(s) of Delivery, and Technical Information for Point(s) of Delivery

- To Be Determined

Exhibit E
City of Bastrop Water CCN

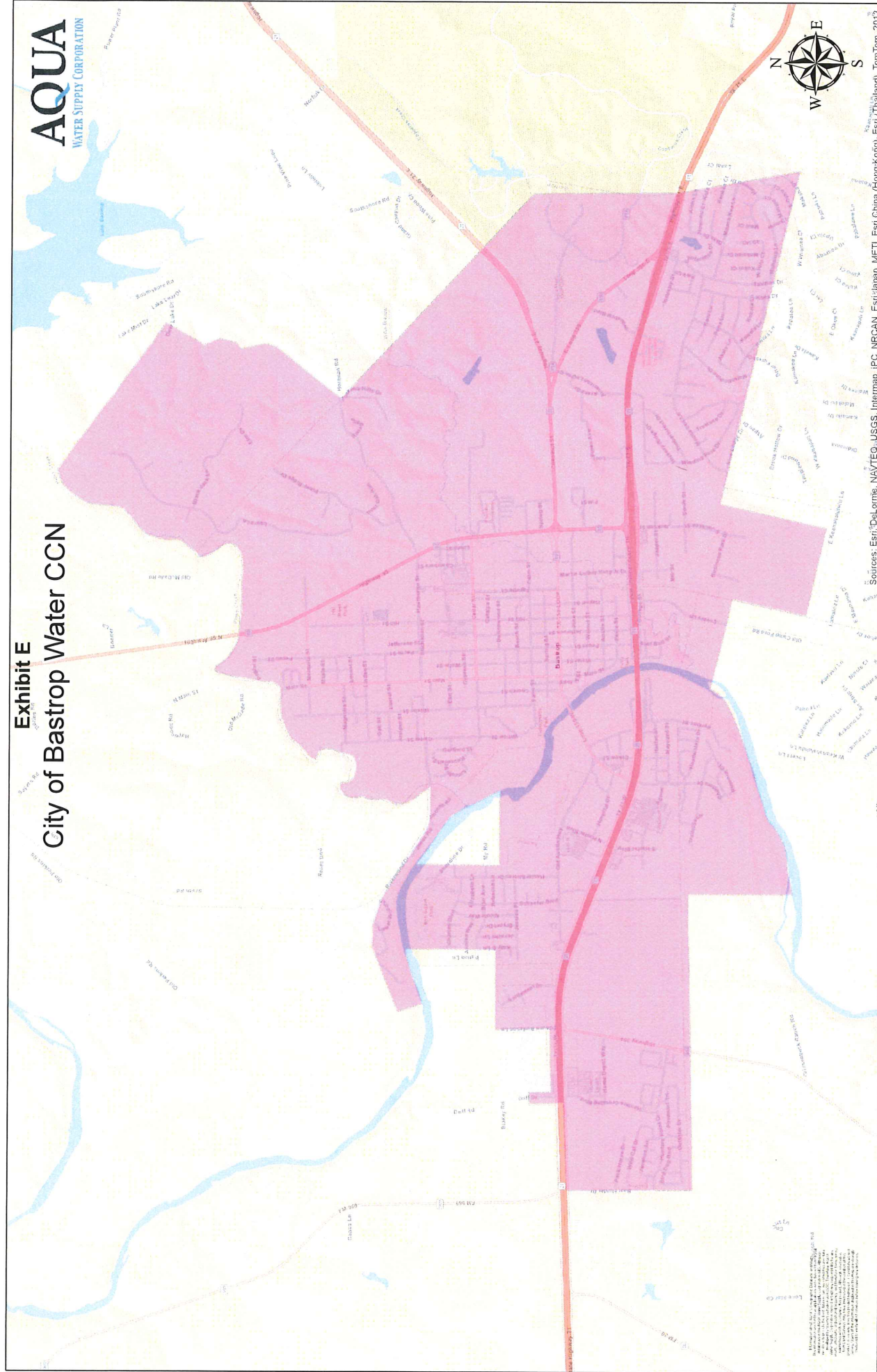

Sources: Esri, DeLorme, NAVTEO, USGS, Intermap, IPC, NRCAN, Esri Japan, METI, Esri China (Hong Kong), Esri (Thailand), TomTom, 2013

Exhibit F City of Bastrop Wastewater CCN

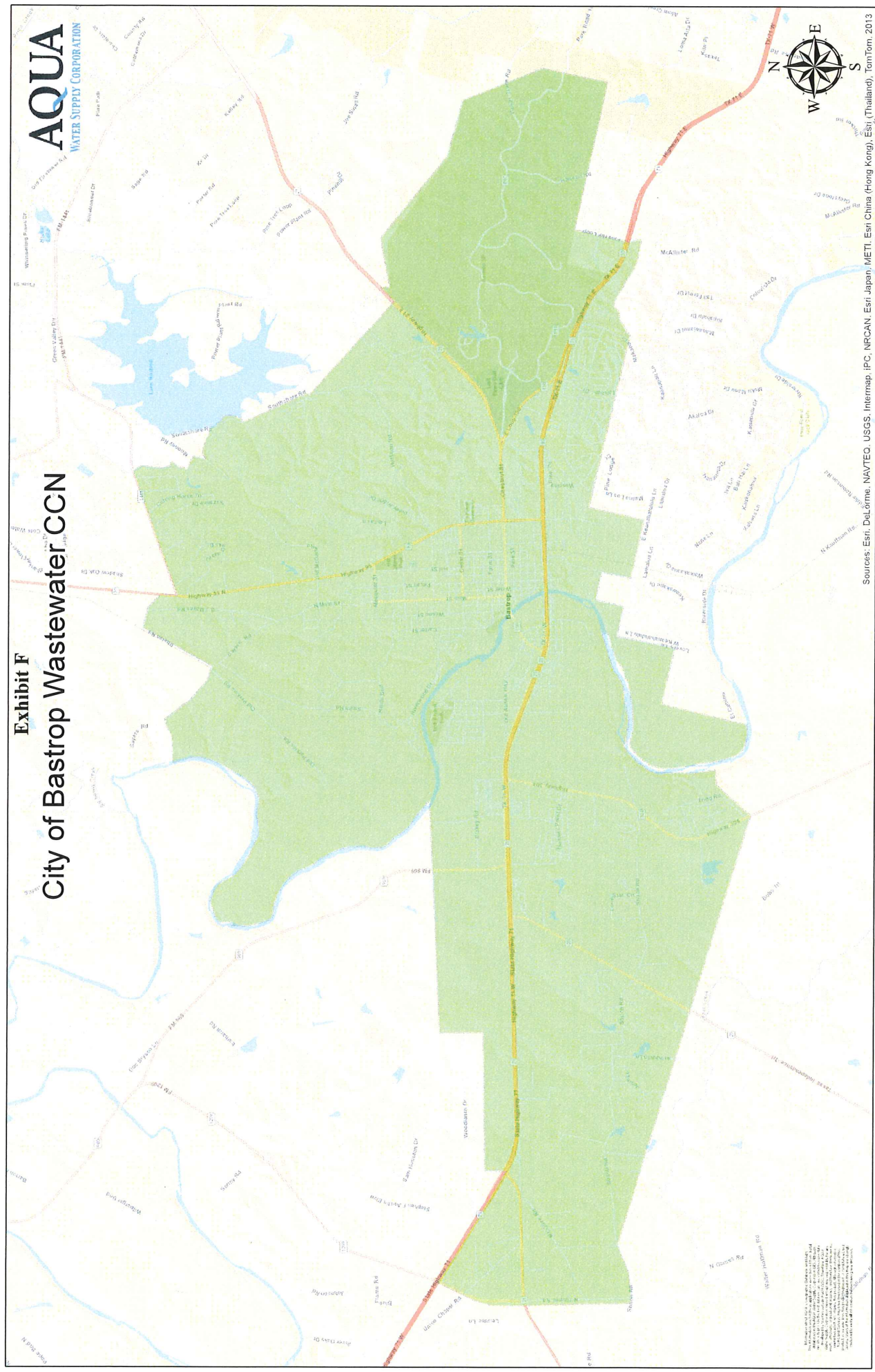

Sources: Esri, DeLorme, NAVTEQ, USGS, Intermap, iPC, NRCAN, Esri Japan, METI, Esri China (Hong Kong), Esri (Thailand), TomTom, 2013

Map data provided by Esri, DeLorme, NAVTEQ, USGS, Intermap, iPC, NRCAN, Esri Japan, METI, Esri China (Hong Kong), Esri (Thailand), TomTom, 2013. All rights reserved. No warranty is made by Esri for the use of the data. Esri and the Esri logo are registered trademarks of Esri. All other trademarks are the property of their respective owners.

RESOLUTION #18.11.02
A RESOLUTION OF THE BOARD OF THE DIRECTORS OF AQUA WATER
SUPPLY CORPORATION AUTHORIZING THE GENERAL MANAGER TO NEGOTIATE AND
EXECUTE A WHOLESALE WATER SERVICE AGREEMENT
WITH THE CITY OF BASTROP

WHEREAS, Aqua Water Supply Corporation ("Aqua") is a non-profit water supply corporation, operating under the authority of Chapter 67 of the Texas Water Code and the holder of retail water Certificate of Convenience No. 10294 ("CCN") issued by the Texas Commission on Environmental Quality; and

WHEREAS, the City of Bastrop ("Bastrop") is a home rule city, body politic of the State of Texas, and retail public utility located adjacent to Aqua's CCN in Bastrop County and the holder of retail water Certificate of Convenience No. 11198 ("CCN") issued by the Texas Commission on Environmental Quality; and

WHEREAS, Bastrop County is experiencing substantial economic and population growth and the growth is likely to continue for the decades to come; and

WHEREAS, Aqua and Bastrop are both integral parts of the past, present, and future of Bastrop County; and

WHEREAS, Aqua and Bastrop strongly agree that the two entities must partner and work together both now and in the future to not only address the growth and water needs that Bastrop County is experiencing but to enable Bastrop County to meet its full potential as a great place to work and live; and

WHEREAS, Aqua and Bastrop believe this Agreement is crucial to making certain the Bastrop area has the water the area needs to grow; and

WHEREAS, Aqua and Bastrop desire to enter a Wholesale Water Service Agreement ("Agreement") that would enable Aqua to provide wholesale water service to Bastrop to allow Bastrop to provide water service in those areas where Bastrop's retail wastewater CCN as of the effective date of the Agreement overlaps with Aqua's retail water CCN; and

WHEREAS, Aqua has determined that it has sufficient facilities and capacity to provide wholesale water service to Bastrop in the areas specified in the Agreement; and

NOW THEREFORE, BE IT RESOLVED BY THE BOARD OF DIRECTORS OF AQUA WATER SUPPLY CORPORATION THAT:

1. The above recitals are true and correct.
2. The General Manager is hereby authorized to negotiate and execute, on behalf of Aqua, a Wholesale Water Service Agreement with the City of Bastrop.
3. The Board of Directors hereby authorizes the President, the General Manager, Aqua staff and Aqua's attorneys and engineers to take any action necessary to implement the terms of this resolution.

PASSED, APPROVED AND ADOPTED this the 5th day of November, 2018.

Cliff Kessler, President

ATTEST:

William F. Tomsu, Secretary/Treasurer

Exhibit H

SECTION 5.0 – WATER RATIONING PLAN

Section 5.01 – General Provisions

1. Declaration of Necessity for Rationing: When system demand threatens to exceed production or storage capability, or refilling the storage facilities is rendered impossible, Aqua, acting through its General Manager, may declare that a necessity for rationing exists, and thereafter ration water in the following manner.
2. Notice Requirements: Reasonable notice, including, by way of example and without limitation, notice published in a local newspaper, radio and television announcements, and by posting notice in public buildings, of the proposed rationing shall be provided 24 hours before Aqua actually starts the program. Published notice may be followed by mailed notice included in the next regular bill. Any notice shall contain the following information:
 - a. the date rationing shall begin;
 - b. the date rationing shall end;
 - c. the stage (level) and explanation of rationing to be employed; and
 - d. explanation of penalties for violations.
3. Violation of Rationing Rules:
 - a. First violation -- Aqua may install a flow restrictor in the line to limit the amount of water which will pass through the meter in a 24-hour period. The cost to be charged to the member's account shall be the actual installed cost to Aqua.
 - b. Subsequent violations -- Aqua may terminate service at the meter for a period of seven (7) days, or until the end of the calendar month, whichever is LESS. The normal reconnect fee of Aqua shall apply for restoration of service.
4. Exemptions or Variances From Rationing Rules: Aqua may grant any member an exemption or variance from the uniform rationing program, for good cause. Aqua shall treat all members equally concerning exemptions and variances, and shall not employ discrimination in such grants.
5. Rates: All existing rates schedules shall remain in effect during the rationing period, and no charges may be levied against a member which are not contained in the approved Tariff of Aqua as filed with the Commission.

The purpose of the Water Rationing Program is to conserve the total amount of water demanded from Aqua until supply can be restored to normal levels.

Section 5.02 – Stages of Rationing

Stage I (Voluntary Conservation)

Under Stage I, Aqua members will be requested to voluntarily restrict usage of water for outdoor purposes such as lawns, gardens, car washing, etc. Members will be requested to voluntarily limit the amount of water used to that amount absolutely necessary for health, business, and outdoor water use. Voluntary Conservation may include following the “Central Texas Water Wise Plan” which includes the following:

1. Landscape Watering Schedule: Aqua will provide a calendar noting the respective outdoor watering days and the order will remain consecutive as new months begin. For members having rural delivery numbers, the last numerical digit of the rural delivery number, whether route or box number, shall be used to determine watering days.
2. Restricted Outdoor Watering Hours: Outdoor watering should be done only before 10 a.m. and after 7 p.m. on your watering day.
3. Restricted Outdoor Watering Volume: Water no more than 1 inch on your watering day.

Stage II (Mild Rationing Conditions)

Under Stage II, Aqua may select one or more of the alternatives listed below, except that usage for livestock is exempt.

1. Time of Use Restriction: Usage of water for outdoor purposes such as lawns, gardens, car washing, etc. may be restricted according to one or more of the following schedules, except that Aqua may allow irrigation by hand-held hoses, hand-held buckets, drip irrigation or permanently installed automatic irrigation sprinkler system only.
 - a. Landscape Watering Schedule: Members with even numbered addresses or rural delivery numbers can use water outdoors on Monday and Thursday and members with odd numbered addresses or rural delivery numbers can use water outdoors on Tuesday and Friday. For members having rural delivery numbers, the last numerical digit of the rural delivery number, whether route or box number, shall be used to determine watering days.
 - b. Weekday Use Only: No outside watering allowed on Saturdays, Sundays, or official Federal holidays.
 - c. Landscape Watering Schedule: Aqua will provide a calendar noting the respective watering days. For members having rural delivery numbers, the

last numerical digit of the rural delivery number, whether route or box number, shall be used to determine watering days.

2. Hand Watering Restriction: Aqua may require that only a hand-held hose or a hand-held bucket be used for watering of lawns, gardens, trees, and shrubs.
3. Vehicle Washing Restriction: Aqua may prohibit or limit the times for washing of automobiles, trucks, trailers, boats, airplanes, and other types of mobile equipment.

Stage III (Moderate Rationing Conditions)

All outdoor water usage is prohibited; however, usage for livestock is exempt.

Stage IV (Severe Rationing Conditions)

All outdoor water usage is prohibited; usage for livestock is exempt. All consumption shall be limited to each member in one of the following ways:

1. A fixed percentage of each member's average use in the prior month, the percentage to be uniformly applied on a system wide basis, each member being notified of this percentage amount, OR
2. A maximum number of gallons per meter (member), per week, with notice to each member of this number.

All meters shall be read as often as necessary to insure compliance with this program for the benefit of all the members.



STAFF REPORT

MEETING DATE: November 13, 2018

AGENDA ITEM: 10A

TITLE:

City Council shall convene into closed executive session pursuant to Section 551.071 of the Texas Government Code to confer with City Attorney regarding legal advice related to the status of the 1445 Interlocal Agreement between the City of Bastrop and Bastrop County for the review of subdivision applications in the City's extraterritorial jurisdiction.

STAFF REPRESENTATIVE:

Lynda K. Humble, City Manager

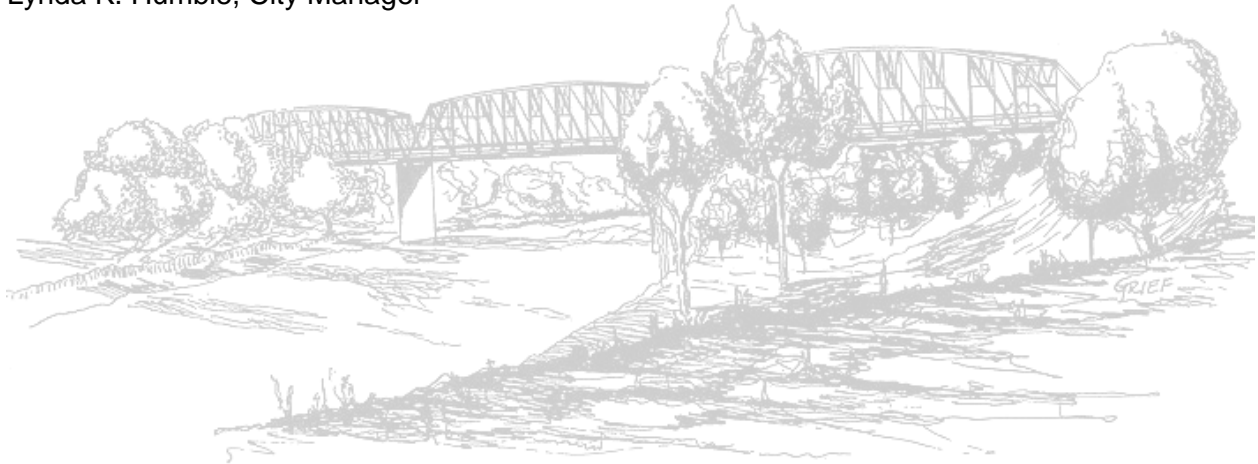



STAFF REPORT

MEETING DATE: November 13, 2018

AGENDA ITEM: 10B

TITLE:

City Council shall convene into closed executive session pursuant to Sections 551.071 of the Texas Government Code to confer with City Attorney seeking legal advice regarding statutory and home-rule charter parameters for public notices, public hearings, community engagement, and city council involvement in the Building Bastrop initiative.

STAFF REPRESENTATIVE:

Lynda K. Humble, City Manager

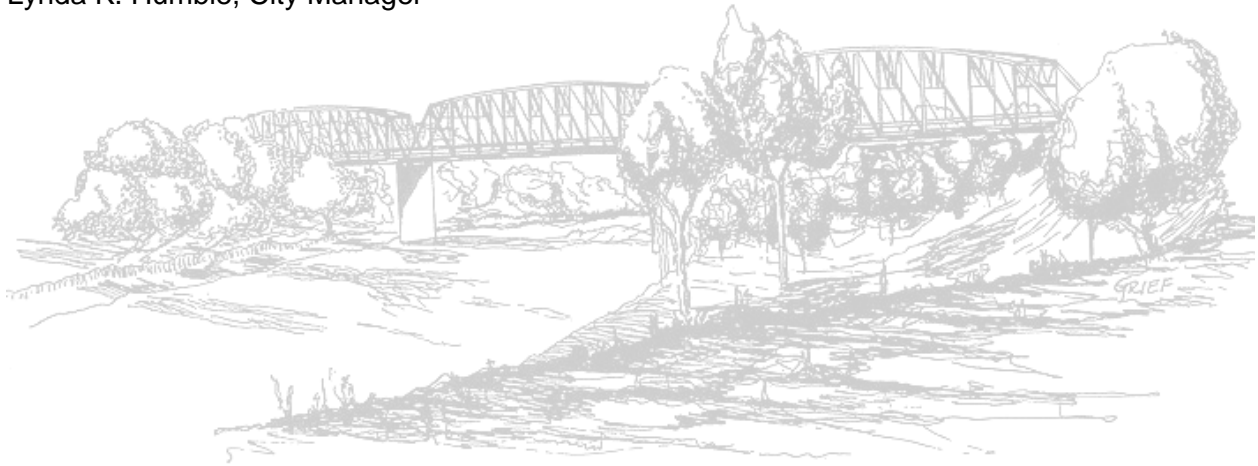



STAFF REPORT

MEETING DATE: November 13, 2018

AGENDA ITEM: 10C

TITLE:

City Council shall convene into closed executive session pursuant to Sections 551.071 of the Texas Government Code to confer with City Attorney seeking legal advice regarding the settlement of outstanding mowing liens on property located at 1002 Church Street.

STAFF REPRESENTATIVE:

Lynda K. Humble, City Manager





STAFF REPORT

MEETING DATE: November 13, 2018

AGENDA ITEM: 11

TITLE:

Take any necessary or appropriate action on matters posted for consideration in closed/executive session

STAFF REPRESENTATIVE:

Lynda Humble, City Manager

